

ITEM 085261 SN01R558-M

Description	Technical data	Accessories	Downloads
-------------	----------------	-------------	-----------

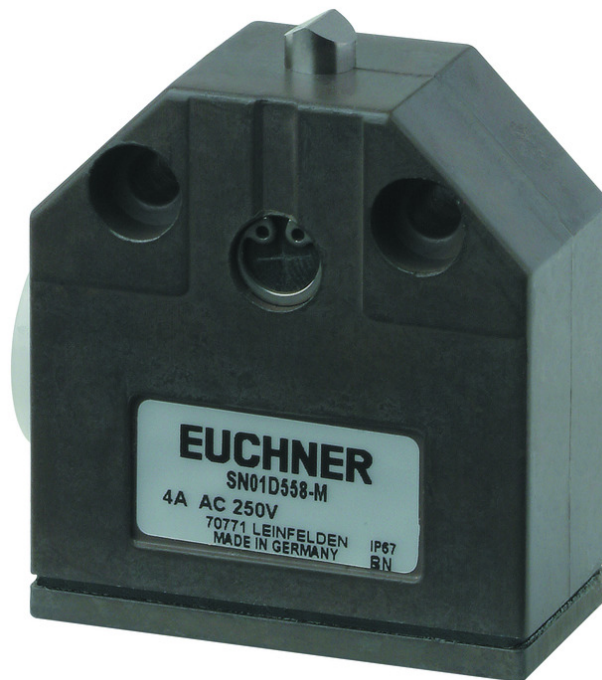

Features

- › Plunger material stainless steel

Approvals



Mechanical values and environment

Housing material	Anodized die-cast alloy
Weight	Net 0,1 kg
Ambient temperature	-5 ... 80 °C
Degree of protection	IP67
Mechanical life	10 x 10 ⁶
Contact material	Silver alloy, gold flashed

Switching principle	Snap-action switching contact
Installation position	Any
Number of door position NC contacts	1
Number of door position NO contacts	1
Connection	1 x M16 x 1.5
Approach speed	max. 0,01 ... 50 m/min
Actuating element Plain bearing metal	Roller plunger ^[1]
Actuating force	15 ... 20 N

Electrical connection ratings

Rated thermal current I_{th}	10 A
Utilization category according to EN 60947-5-1	AC-15 4A 230V DC-13 3A 24V
Short circuit protection according to IEC 60269-1	(Fuse) 10A gG
Rated insulation voltage U_i	250 V
Rated impulse withstand voltage U_{imp}	2,5 kV
Switching current	Min. at DC 5V 10 mA
Connection cross-section	0,14 ... 1 mm ² ^[2]

[1] D roller = 5 mm

[2] Soldered connection

Dimension drawing

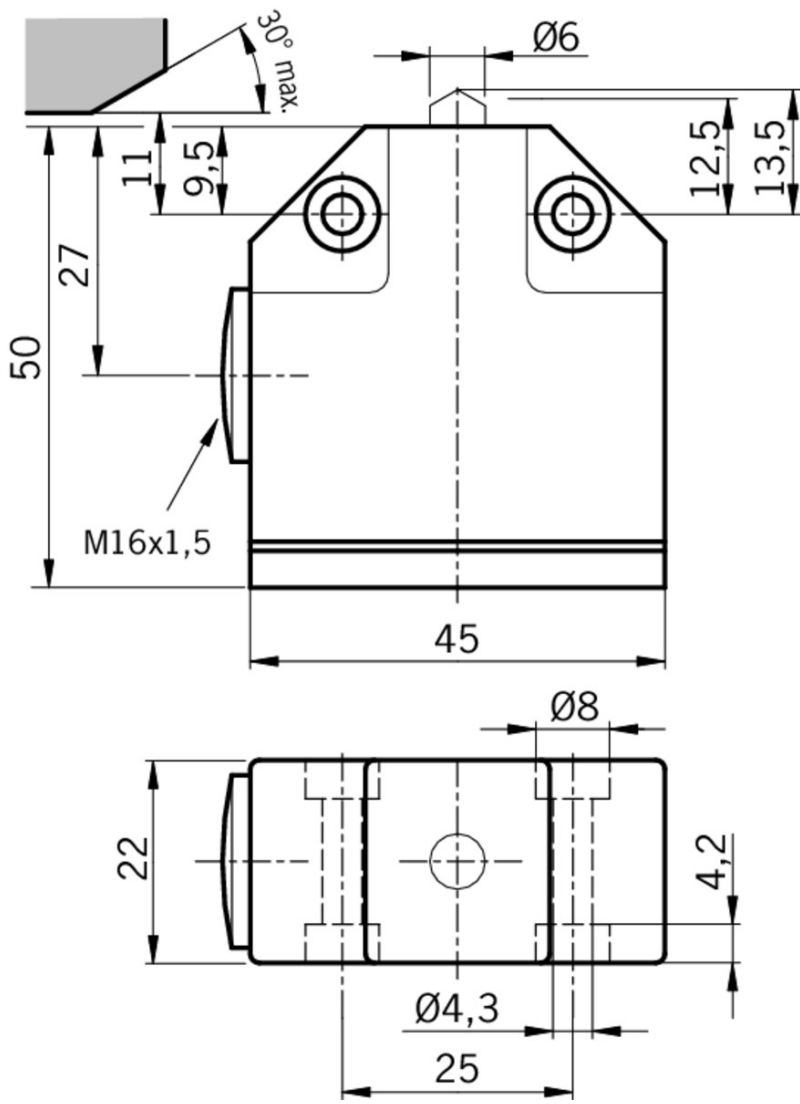

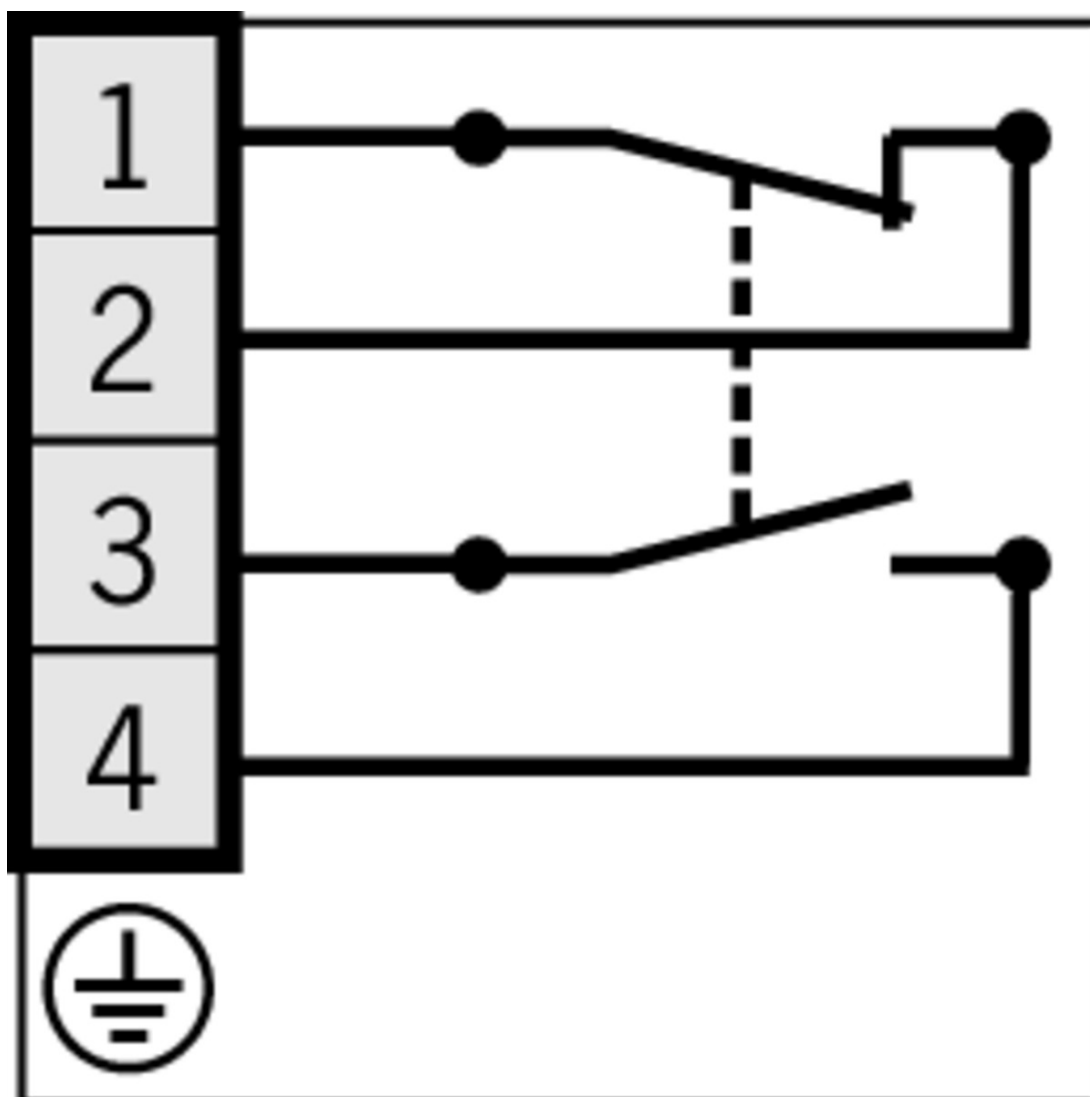





Instructions

✓ Manual de instrucciones Finales de carrera unitarios de precisión N01/NB01/SN01

	Doc. no.	Version	Language	Download
Betriebsanleitung Präzisions-Einzelgrenztaster N01/NB01/SN01 Operating Instructions Precision Single Limit Switches N01/NB01/SN01	2105376	06-02/18		0.9 MB
Mode d'emploi Monopistes de précision N01/NB01/SN01	2105376	06-02/18		0.5 MB
Manual de instrucciones Finales de carrera unitarios de precisión N01/NB01/SN01	2105376	06-02/18		0.5 MB
Istruzioni di impiego Finecorsa di precisione singoli N01/NB01/SN01	2105376	06-02/18		0.5 MB

Catalogs

 Positionsschalter und Reihengrenztaster Position Switches and Multiple Limit Switches
Interrupteurs de position et boîtiers multipistes

	Doc. no.	Version	Language	Download
Positionsschalter und Reihengrenztaster	157835	01-03/18		 4.1 MB
Interrupteurs de position et boîtiers multipistes	157837	01-03/18		 4.1 MB
Position Switches and Multiple Limit Switches	157836	01-03/18		 4.1 MB

CAD data

CAD data for this item on TraceParts