

**ITEM 078485 N1AR502-M**

Description	Technical data	Accessories	Downloads
-------------	----------------	-------------	-----------

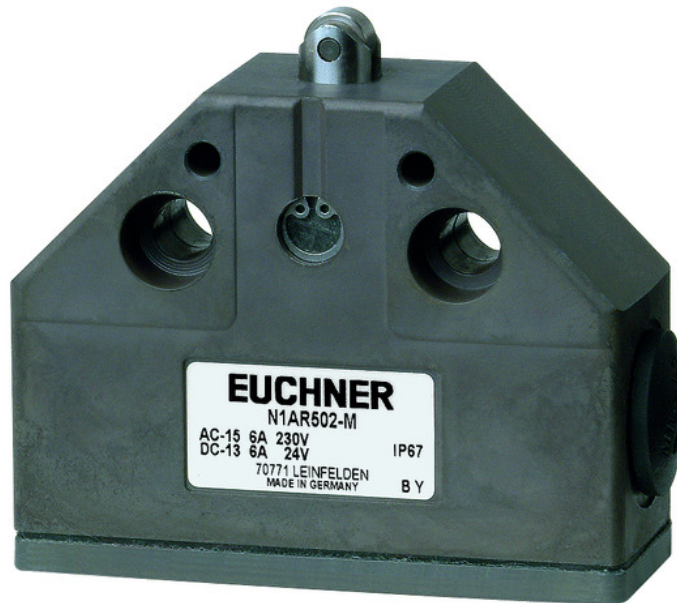

**Features**

- › Plunger material stainless steel
- › Housing according to DIN 43693

**Approvals**



**Mechanical values and environment**

Contact bounce time	< 3ms
Contact closing time	< 4ms
Design	Housing according to DIN 43693
Housing material	Anodized die-cast alloy
Weight	
	Net 0,25 kg

Ambient temperature	-5 ... 80 °C
Degree of protection	IP67
Mechanical life	30 x 10 <sup>6</sup>
Contact material	Silver alloy, gold flashed
Switching principle	Snap-action switching contact
Installation position	Any
Number of switching elements	1
Number of NC contacts	1
Number of NO contacts	1
Connection	2 x M16 x 1.5
Approach speed	max. 0,01 ... 80 m/min
Actuating element	Roller plunger <b>[1]</b>
Roller diameter	8 mm
Actuating force	min.20 N
Operating point accuracy	± 0.01 <b>[2]</b>

### Electrical connection ratings

Rated thermal current I <sub>th</sub>	8 A
Utilization category according to EN 60947-5-1	AC-15 6A 230V DC-13 6A 24V AC-12 8 A, 250 V
Short circuit protection according to IEC 60269-1	(Fuse) 8A gG
Rated insulation voltage U <sub>i</sub>	250 V
Rated impulse withstand voltage U <sub>imp</sub>	2,5 kV
Switching current	Min. at DC 12V 10 mA
Connection cross-section	0,34 ... 1,5 mm <sup>2</sup>

**[1]** Plain bearing

**[2]** The reproducible switching point accuracy refers to the axial travel of the plunger after the switching element ES 502 E has been run-in with approx. 2000 operating cycles.

Dimension drawing

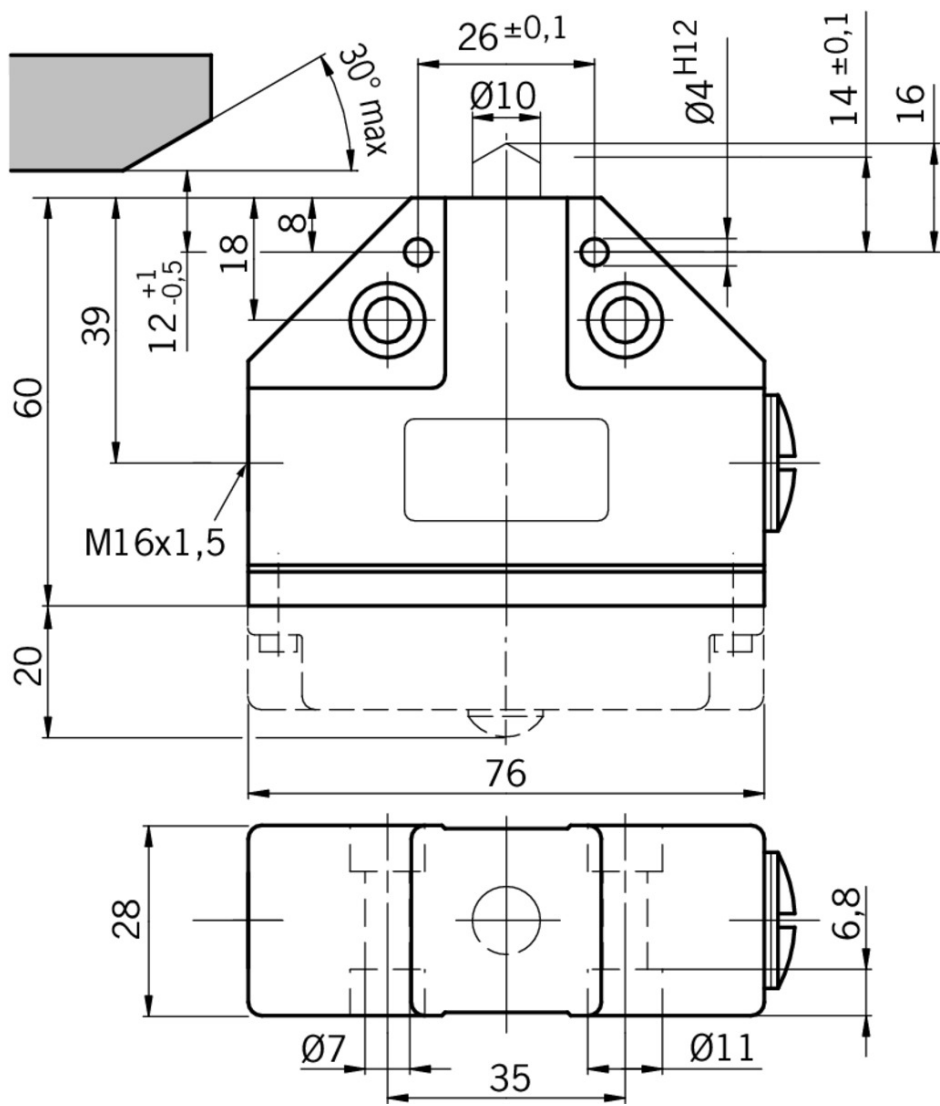

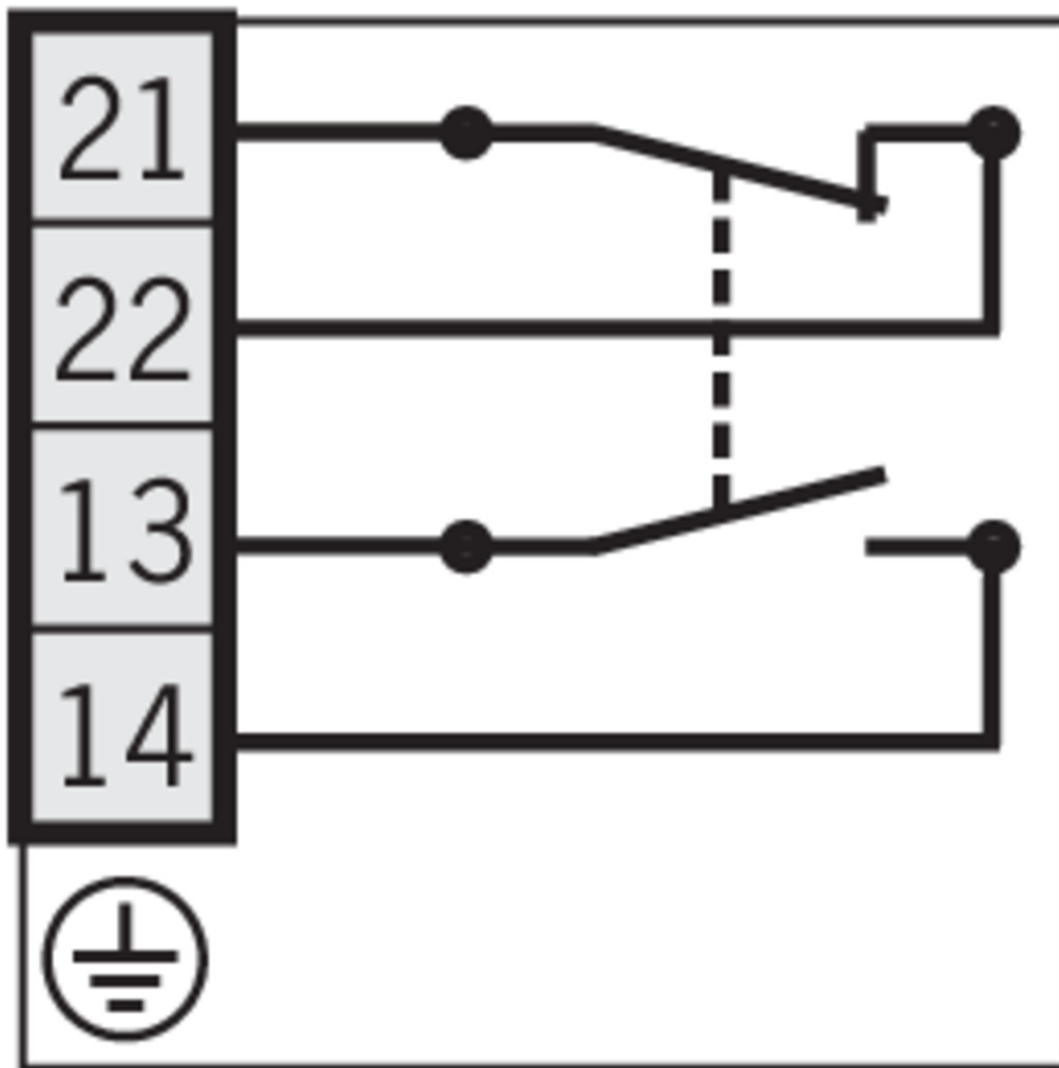

## ES502E









### Instructions

✓ Manual de instrucciones Finales de carrera unitarios de precisión N1A

	Doc. no.	Version	Language	Download
Betriebsanleitung Präzisions-Einzelgrenztaster N1A Operating Instructions Precision Single Limit Switches N1A	2032309	12-01/18	 	 0.8 MB
Mode d'emploi Monopistes de précision N1A	2032309	12-01/18		 0.4 MB
Manual de instrucciones Finales de carrera unitarios de precisión N1A	2032309	12-01/18		 0.4 MB
Istruzioni di impiego Finecorsa di precisione singoli N1A	2032309	12-01/18		 0.4 MB

### Catalogs

 Positionsschalter und Reihengrenztaster Position Switches and Multiple Limit Switches  
Interrupteurs de position et boîtiers multipistes

	<b>Doc. no.</b>	<b>Version</b>	<b>Language</b>	<b>Download</b>
Positionsschalter und Reihengrenztaster	157835	01-03/18		 4.1 MB
Interrupteurs de position et boîtiers multipistes	157837	01-03/18		 4.1 MB
Position Switches and Multiple Limit Switches	157836	01-03/18		 4.1 MB

**CAD data**

CAD data for this item on TraceParts