

ITEM 083847 N1AK502-M

Description	Technical data	Accessories	Downloads
-------------	----------------	-------------	-----------

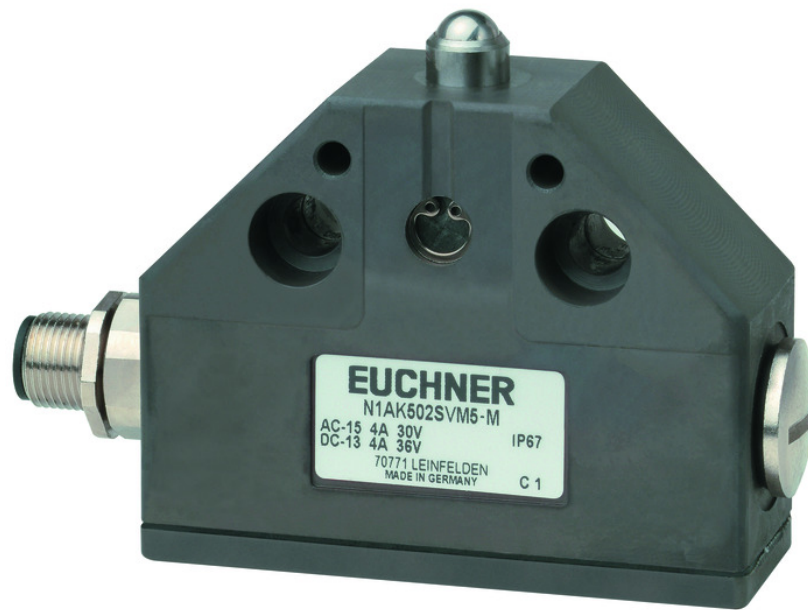

Features

- › Plunger material stainless steel
- › Housing according to DIN 43693

Approvals



Mechanical values and environment

Contact bounce time	< 3ms
Contact closing time	< 4ms
Design	Housing according to DIN 43693
Housing material	Anodized die-cast alloy
Weight	
	Net 0,25 kg

Ambient temperature	-5 ... 80 °C
Degree of protection	IP67
Mechanical life	30 x 10 ⁶
Contact material	Silver alloy, gold flashed
Switching principle	Snap-action switching contact
Installation position	Any
Number of switching elements	1
Number of NC contacts	1
Number of NO contacts	1
Connection	2 x M16 x 1.5
Approach speed	max. 0,01 ... 10 m/min
Actuating element	Ball plunger
Actuating force	min.20 N
Operating point accuracy	± 0.002 [1]

Electrical connection ratings

Rated thermal current I _{th}	8 A
Utilization category according to EN 60947-5-1	AC-15 6A 230V DC-13 6A 24V AC-12 8 A, 250 V
Short circuit protection according to IEC 60269-1	(Fuse) 8A gG
Rated insulation voltage U _i	250 V
Rated impulse withstand voltage U _{imp}	2,5 kV
Switching current	Min. at DC 12V 10 mA
Connection cross-section	0,34 ... 1,5 mm ²

[1] The reproducible switching point accuracy refers to the axial travel of the plunger after the switching element ES 502 E has been run-in with approx. 2000 operating cycles.

Dimension drawing

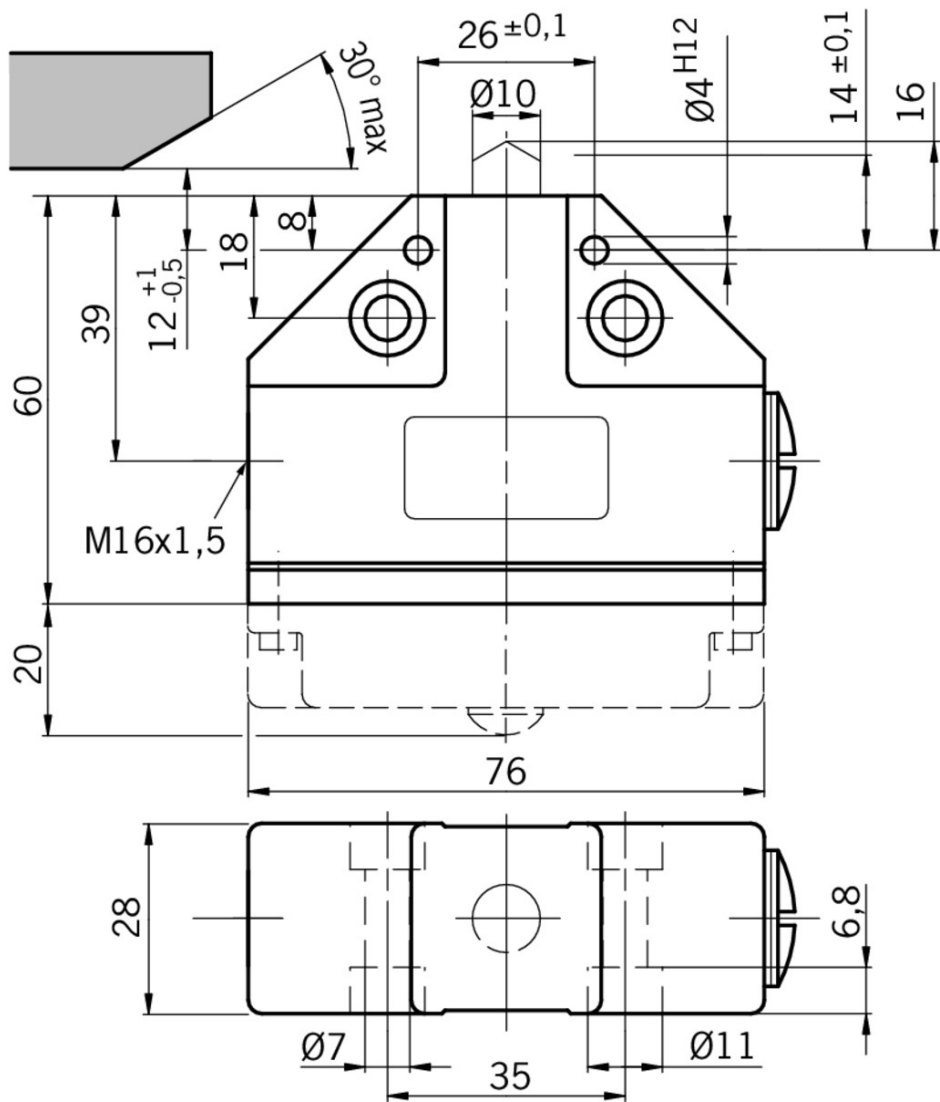

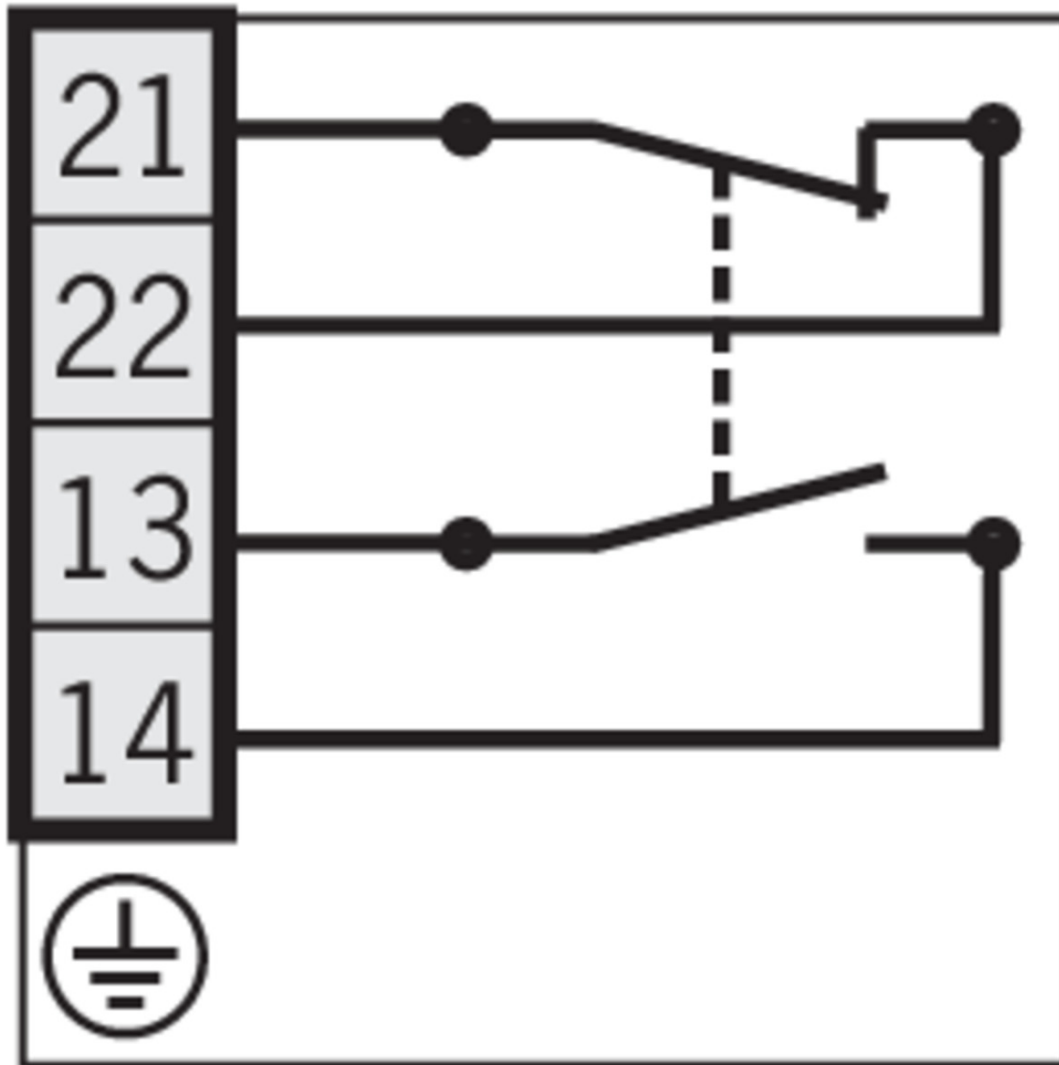

ES502E









Instructions

✓ Manual de instrucciones Finales de carrera unitarios de precisión N1A

	Doc. no.	Version	Language	Download
Betriebsanleitung Präzisions-Einzelgrenztaster N1A Operating Instructions Precision Single Limit Switches N1A	2032309	12-01/18	 	 0.8 MB
Mode d'emploi Monopistes de précision N1A	2032309	12-01/18		 0.4 MB
Manual de instrucciones Finales de carrera unitarios de precisión N1A	2032309	12-01/18		 0.4 MB
Istruzioni di impiego Finecorsa di precisione singoli N1A	2032309	12-01/18		 0.4 MB

Catalogs

 Positionsschalter und Reihengrenztaster Position Switches and Multiple Limit Switches
Interrupteurs de position et boîtiers multipistes

	Doc. no.	Version	Language	Download
Positionsschalter und Reihengrenztaster	157835	01-03/18		 4.1 MB
Interrupteurs de position et boîtiers multipistes	157837	01-03/18		 4.1 MB
Position Switches and Multiple Limit Switches	157836	01-03/18		 4.1 MB

CAD data

CAD data for this item on TraceParts