

**ITEM 156391 MGB2-L2HB-PN-U-S3-D-L-156391**

Description	Technical data	Accessories	Downloads
-------------	----------------	-------------	-----------



**Features**

- › Guard locking with guard lock monitoring
- › Illuminated emergency stop according to ISO 13850
- › Two illuminated pushbuttons
- › Three slide-in labels
- › Connection via plug connector RJ45, AIDA compliant
- › Integrated switch
- › Adjustable door hinge; factory setting: left
- › Unicode

**Guard locking type**

**MGB2-** Guard locking by solenoid force. Activation of the guard locking by  
**L2...** applying voltage to the guard locking solenoid. (Open-circuit current principle)

**PROFINET interface**

Plug connector RJ45 AIDA-compliant (push-pull plug according to IEC 61076-3-117, variant 14)

## PROFINET switch

Linear topology network structure due to integrated switch (supports MRP).

---

## Flexible use as interlocking or guard locking

By means of the corresponding evaluation of the safe device data by the control system, use can be as either interlocking or guard locking (with or without monitoring).

---

## Lens set

The color of the pushbuttons can be selected using the lens set 120344 included (five colors).

---

## Slide-in labels

The user can produce custom labeling using the enclosed slide-in labels (three, blank)

## Components included in the set



156381 Locking module MGB2-L2-MLI-U-YB1A1-DA-L-156381  
Features

---



156310 Bus module MBM-PN-S3-MLI-3B-156310  
Features

---



156394 Handle module MGB2-H-BA1A3-L-156394  
Features

---

## Miscellaneous

Additional feature	Incl. cover set ID. No. 120344
Slide-in label	3 pc. without marking

# Dimension drawing

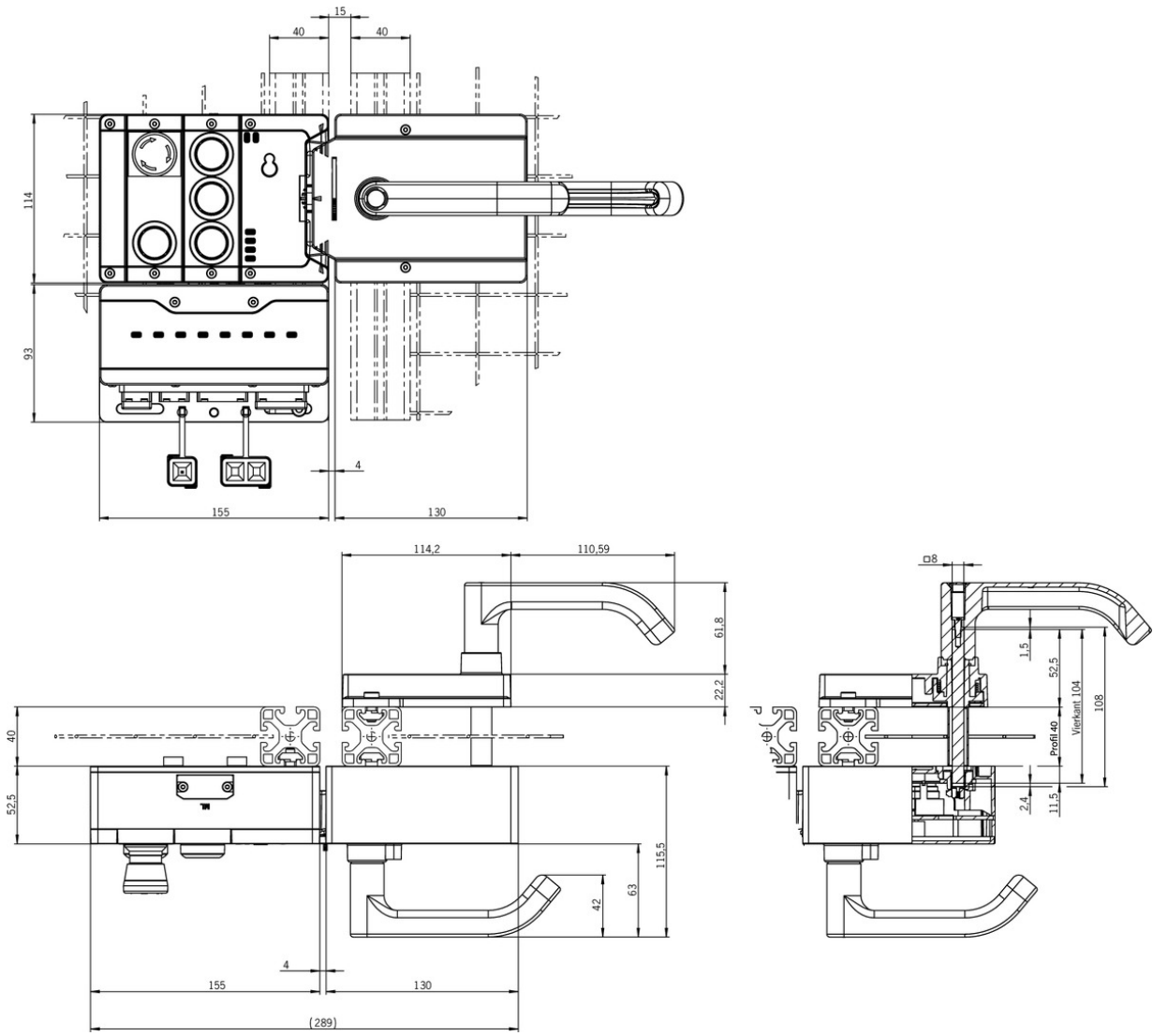

## Dimension drawing

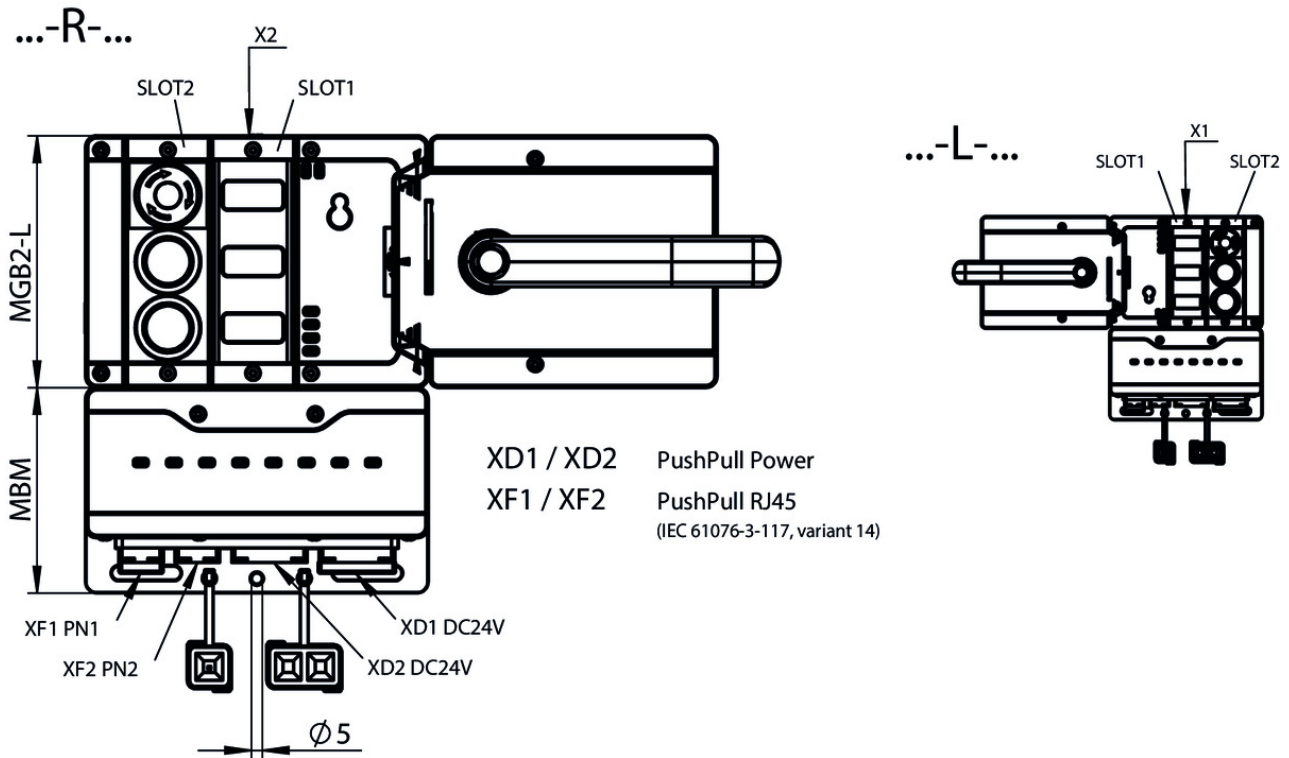

## Connection material

- ☑ Module connector MLI (M12), 5-pin, plug



**157024** AC-MC-SB-M-A-157024

☑ Features

- › Module plug connector MLI (M12), straight
- › Number of pins: 5-pin , plug

- ☑ Cover for unused MLI connections



**156718** AC-MC-00-0-B-156718

☑ Features

- › Cover for unused connections
- › incl. fixing screws
- › incl. seal

- ☑ Module connector MLI, 5-pin, socket



**157025** AC-MC-SB-F-B-157025

☑ Features

- › Module plug connector MLI, straight
- › Directly pluggable (without thread)
- › Number of pins: 5-pin, socket

- ☑ Module connector MLI (M12), 5-pin, socket



### **157028** AC-MC-SB-F-A-157028

#### ✓ Features

- › Module plug connector MLI (M12), straight
  - › With thread
  - › Number of pins: 5-pin, socket
- 

## Function expansion

---

### ✓ Escape release MGB-E-A...



### **100465** MGB-E-A-100465

#### ✓ Features

- › Escape release from the danger zone
  - › Door handle signal red
  - › Extended actuation axis for thicker doors (available optionally)
- 

### ✓ Escape release MGB-E-A7...

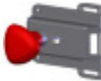

### **117126** MGB-E-A7-117126

#### ✓ Features

- › Escape release from the danger zone
  - › Door knob signal red
  - › Extended actuation axis for thicker doors (available optionally)
- 

### ✓ Expansion module MCM-MLI-YA4A4A4A4-JA (with four slots for submodules, one MLI connection)



### **157774** MCM-MLI-YA4A4A4A4-JA-157774

#### ✓ Features

- › Function expansion for bus module MBM and locking module MGB2-L.-MLI
  - › Four slots for mounting submodules
  - › Category 4/PL e for the evaluation of all safety functions
  - › Four blanking covers
  - › Submodule connection type: N/P
  - › Compatible with all Modular devices
- 

### ✓ Extension module MCM-MLI-Y00000000-JJ-157854 (open version without submodules, with four slots, one MLI connection)



### **157854** MCM-MLI-Y00000000-JJ-157854

#### ✓ Features

- › Function expansion for bus module MBM and locking module MGB2-L.-MLI
  - › Four slots for mounting submodules
  - › Category 4/PL e for the evaluation of all safety functions
  - › Open version (without submodules)
  - › Submodule connection type: N/P
  - › Compatible with all Modular devices
- 

### ✓ Door handle for MGB2-H..., silver



### **156944** AY-DHL-S1-156944

▼ Features

- › For mounting on all MGB2 handle modules MGB2-H...
  - › For mounting on all MGBS handle modules MGBS-H...
  - › Aluminum, silver anodized
- 

▼ Door knob for MGB2-H..., silver



**157017** AY-DKB-S1-157017

▼ Features

- › For mounting on all MGB2 handle modules MGB2-H...
  - › For mounting on all MGBS handle modules MGBS-H...
  - › e.g. on sliding doors
  - › Aluminum, silver anodized
- 

## Miscellaneous accessories

---

▼ Lens set 6 colors



**120378** AY-SET-LNS-0002-120378

---

▼ Lens set 5 colors



**120344** AY-SET-LNS-0001-120344

---

▼ Lens set labeled



**120377** AY-SET-LNS-SY01-120377

---



**125359** AY-SET-LNS-SY02-125359

---



**126158** AY-SET-LNS-SY03-126158

---

▼ Adhesive labels





**114529** MGB-A-PLATESET-NN01-114529

▼ Features

- › Adhesive labels suitable for MGB evaluation modules, bus modules and control modules
  - › silver, blank
  - › Packaging unit = 10 pcs.
-

## Instructions

### ▼ Betriebsanleitung Busmodul MBM-PN-...-MLI-... (PROFINET) und ab V1.0.0









	Doc. no.	Version	Language	Download
Betriebsanleitung Busmodul MBM-PN-...-MLI-... (PROFINET) und ab V1.0.0	2500235	02-09/18		 5.4 MB
Mode d'emploi Module de bus MBM-PN-...-MLI-... (PROFINET) et À partir de V1.0.0	2500235	02-09/18		 5.4 MB
Manual de instrucciones Módulo de bus MBM-PN-...-MLI-... (PROFINET) y V1.0.0 o superior	2500235	02-09/18		 5.4 MB
Operating Instructions Bus Module MBM-PN-...-MLI-... (PROFINET) from V1.0.0	2500235	02-09/18		 5.4 MB

### ▼ Betriebsanleitung Verriegelungs-/Zuhaltemodule MGB2-I...-MLI-... / MGB2-L...-MLI-... (Modular) ab V1.00.0

	Doc. no.	Version	Language	Download
Betriebsanleitung Verriegelungs-/Zuhaltemodule MGB2-I...-MLI-... / MGB2-L...-MLI-... (Modular) ab V1.00.0	2500234	02-09/18		 4.4 MB
Mode d'emploi Modules de verrouillage / interverrouillage MGB2-I...-MLI-... / MGB2-L...-MLI-... (Modular) et À partir de V1.00.0	2500234	02-09/18		 4.4 MB
Manual de instrucciones Módulos de enclavamiento o bloqueo MGB2-I...-MLI-.../MGB2-L...-MLI-... (Modular) y V1.00.0 o superior	2500234	02-09/18		 4.4 MB
Operating Instructions Interlocking/Locking Modules MGB2-I...-MLI-... / MGB2-L...-MLI-... (Modular) and from V1.00.0	2500234	02-09/18		 4.4 MB



## Catalogs

### ▼ Multifunctional Gate Box MGB2 Modular Multifunctional Gate Box MGB2 Modular Multifunctional Gate Box MGB2 Modular Multifunctional Gate Box MGB2 Modular

	Doc. no.	Version	Language	Download
Multifunctional Gate Box MGB2 Modular	159037	02-09/18		 14.3 MB
Multifunctional Gate Box MGB2 Modular	159050	02-09/18		 14.4 MB
Multifunctional Gate Box MGB2 Modular	159051	02-09/18		 14.4 MB
Multifunctional Gate Box MGB2 Modular	159039	02-09/18		 14.4 MB

## Application example

### ▼ Einbindung MGB2 in das TIA Portal V13/V14/V15

	Doc. no.	Version	Language	Download
Einbindung MGB2 in das TIA Portal V13/V14/V15	AP000232	01-06/18		 1.6 MB