



Operating manual

EA16

Measured value display
Component for panel installation

09005809 • BA_EN_EA16 • Rev. ST4-B • 01/19

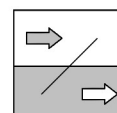

Masthead

Manufacturer:**FISCHER Mess- und Regeltechnik GmbH**Bielefelderstr. 37a
D-32107 Bad SalzufenTelephone: +49 5222 974 0
Telefax: +49 5222 7170eMail: info@fischermesstechnik.deweb: www.fischermesstechnik.de**Technical editorial team:**Documentation representative: T. Malischewski
Technical editor: R. Kleemann

All rights, also those to the translation, reserved. No part of this document may be reproduced or processed, duplicated or distributed using electronic systems or any other form (print, photocopy, microfilm or another process) without the written consent of the company FISCHER Mess- und Regeltechnik GmbH, Bad Salzufen.

Reproduction for internal use is expressly allowed.

Brand names and procedures are used for information purposes only and do not take the respective patent situation into account. Great care was taken when compiling the texts and illustrations; Nevertheless, errors cannot be ruled out. The company FISCHER Mess- und Regeltechnik GmbH will not accept any legal responsibility or liability for this.

Subject to technical amendments.



© FISCHER Mess- und Regeltechnik GmbH

Version history

Rev. ST4-A 03/16	Version 1 (first edition)
Rev. ST4-B 01/19	Version 2 (new versions)

Table of Contents

1	Safety guidelines	5
1.1	General	5
1.2	Personnel Qualification	5
1.3	Risks due to Non-Observance of Safety Instructions	5
1.4	Safety Instructions for the Operating Company and the Operator	5
1.5	Unauthorised Modification	5
1.6	Inadmissible Modes of Operation	6
1.7	Safe working practices for maintenance and installation work	6
1.8	Pictogram explanation	6
2	Product and functional description	7
2.1	Use as intended	7
2.2	Function diagram	7
2.3	Design and mode of operation	8
3	Installation and assembly	9
4	Commissioning	10
4.1	General	10
4.2	Measured value display	11
4.2.1	Tile view	11
4.2.2	List view	13
4.2.3	Presentation variants	15
4.3	Control elements	16
5	Parameterization	18
5.1	General Information	18
5.2	Navigation in the menu tree	18
5.3	Value input	19
5.3.1	Input of number values	19
5.3.2	Text input	19
5.3.3	Select parameter values	20
5.3.4	Dialogue box	20
5.4	Main menu [Level 1]	21
5.4.1	Menu: History [Level 2]	22
5.4.1.1	Graphic display	22
5.4.2	Menu: Event log [Level 2]	29
5.4.3	Menu: Log on / log off [Level 2]	30
5.4.4	Menu: Configuration [Level 2]	31
5.4.4.1	Menu: Display [Level 3]	32
5.4.4.2	Menu: Switch outputs [Level 3]	33
5.4.4.3	Menu: Inputs [Level 3]	40
5.4.4.4	Menu: Outputs [Level 3]	68
5.4.4.5	Menu: Datalogger [Level 3]	72
5.4.5	Menu: Language [Level 2]	76

5.4.6	Menu: System [Level 2]	76
5.4.6.1	Menu: Configuration [Level 3]	77
5.4.6.2	Menu: Overview inputs/outputs [Level 3]	77
5.4.6.3	Menu: System info [Level 3]	78
5.4.6.4	Menu: Firmware update [Level 3]	79
5.4.6.5	Menu: Date/Time [Level 3]	79
5.4.6.6	Menu: Unmount SD card [Level 3]	80
5.4.6.7	Menu: Data transfer SD->USB [Level 3]	81
5.4.6.8	Menu: Convert log data [Level 3]	81
5.4.6.9	Menu: Delete SD card [Level 3]	82
5.4.6.10	Menu: Change passwords [Level 3]	82
6	Technical data	83
6.1	Generalities	83
6.2	Input variables	83
6.2.1	Analogue inputs A1 ... A4	83
6.2.2	Digital inputs I/O1 ... I/O4	83
6.3	Output parameters	83
6.3.1	Analogue outputs A1 ... A4	83
6.3.2	Digital outputs I/O1 ... I/O4	84
6.3.3	Switching outputs K1 ... k4	84
6.4	Measurement accuracy	84
6.5	Digital interfaces	85
6.6	Display and operating interface	85
6.7	Auxiliary energy	85
6.8	Application conditions	85
6.9	Construction design	85
7	Order Codes	86
8	Attachments	87
8.1	EU Declaration of Conformity	87

1 Safety guidelines

1.1 General



WARNING

This operating manual contains instructions fundamental to the installation, operation and maintenance of the device that must be observed unconditionally. It must be read by the assembler, operator and the specialized personnel in charge of the instrument before it is installed and put into operation.

This operating manual is an integral part of the product and therefore needs to be kept close to the instrument in a place that is accessible at all times to the responsible personnel.

The following sections, in particular instructions about the assembly, commissioning and maintenance, contain important information, non-observance of which could pose a threat to humans, animals, the environment and property.

The instrument described in these operating instructions is designed and manufactured in line with the state of the art and good engineering practice.

1.2 Personnel Qualification

The instrument may only be installed and commissioned by specialized personnel familiar with the installation, commissioning and operation of this product.

Specialized personnel are persons who can assess the work they have been assigned and recognize potential dangers by virtue of their specialized training, their skills and experience and their knowledge of the pertinent standards.

1.3 Risks due to Non-Observance of Safety Instructions

Non-observance of these safety instructions, the intended use of the device or the limit values given in the technical specifications can be hazardous or cause harm to persons, the environment or the plant itself.

The supplier of the equipment will not be liable for damage claims if this should happen.

1.4 Safety Instructions for the Operating Company and the Operator

The safety instructions governing correct operation of the instrument must be observed. The operating company must make them available to the installation, maintenance, inspection and operating personnel.

Dangers arising from electrical components, energy discharged by the medium, escaping medium and incorrect installation of the device must be eliminated. See the information in the applicable national and international regulations.

Please observe the information about certification and approvals in the Technical Data section.

1.5 Unauthorised Modification

Modifications or other technical alterations to the instrument by the customer are not permitted. This also applies to replacement parts. Only the manufacturer is authorised to make any modifications or changes.

1.6 Inadmissible Modes of Operation

The operational safety of this instrument can only be guaranteed if it is used as intended. The instrument model must be suitable for the medium used in the system. The limit values given in the technical data may not be exceeded.

The manufacturer is not liable for damage resulting from improper or incorrect use.

1.7 Safe working practices for maintenance and installation work

The safety instructions given in this operating manual, any nationally applicable regulations on accident prevention and any of the operating company's internal work, operating and safety guidelines must be observed.

The operating company is responsible for ensuring that all required maintenance, inspection and installation work is carried out by qualified specialized personnel.

1.8 Pictogram explanation



DANGER

Type and source of danger

This indicates a **direct** dangerous situation that could lead to death or **serious injury** (highest danger level).

- a) Avoid danger by observing the valid safety regulations.



WARNING

Type and source of danger

This indicates a **potentially** dangerous situation that could lead to death or **serious injury** (medium danger level).

- a) Avoid danger by observing the valid safety regulations.



CAUTION

Type and source of danger

This indicates a **potentially** dangerous situation that could lead to slight or serious injury, damage or **environmental pollution** (low danger level).

- a) Avoid danger by observing the valid safety regulations.



NOTICE

Note / advice

This indicates useful information of advice for efficient and smooth operation.

2 Product and functional description

2.1 Use as intended

The EA16 is a measuring value display unit for measuring transducers with output signals for current and voltage acc. to IEC 60381. Up to four measuring transducers in two or three-conductor versions can be connected.

Typical applications

- Measured value display in clean room

Important features

- 3.5" (8.9 cm) TFT Touch LCD colour display
- Configurable colour switching
- 2 or 4 channel mode with ...
 - 2 or 4 configurable analogue inputs for uniform signals (0/4 ... 20 mA, 0 ... 10 V) acc. to IEC 60381 (signal ranges ca be selected freely within the limits; see Technical Data)
 - 2 or 4 configurable analogue outputs with possibility of characteristic curve spread and reversal with any offset
 - 2 or 4 configurable switching outputs with potential-free relay contacts or semiconductor switches
- USB interface
- Optional Modbus RTU interface
- Optional data logger function with data storage on Micro SD card
- Configuration of all parameters and a measuring point protocol⁽¹⁾ are possible via PC software

2.2 Function diagram

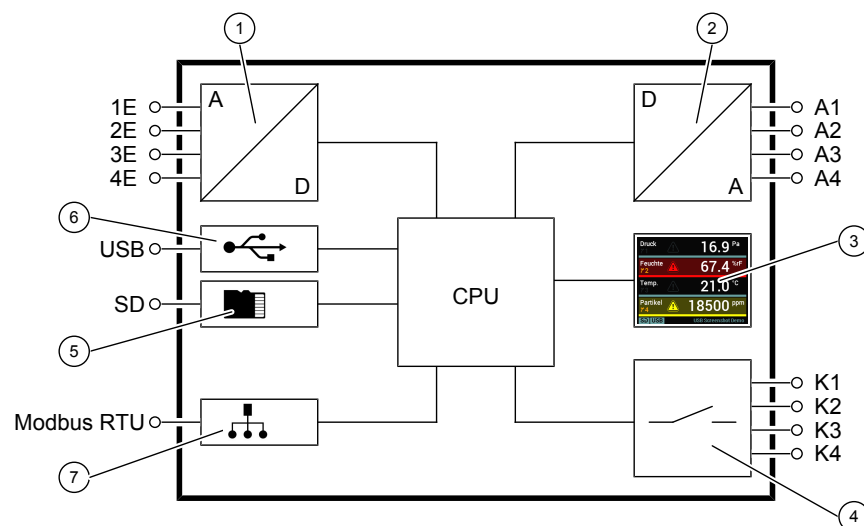

Fig. 1: Function diagram

1	Analogue inputs	2	Analogue outputs
3	Touch colour display	4	Switching outputs
5	Micro SD memory card	6	Micro USB interface
7	Modbus interface (option)		

⁽¹⁾ parameter profile

2.3 Design and mode of operation

The measuring signals of up to four connected measuring transducers can be analysed simultaneously by the microcontroller electronics. The configurable 3.5" touch display can display up to four measuring values at the same time. A configurable colour switch serves to present specific operating modes. Optionally, the device can be delivered with a data logger function.

The processed input signals are converted into the following output signals:

- 2 or 4 configurable switching outputs. Parameters, such as activation and deactivation points, switching function or delay, are available for this purpose. The switching states are displayed with symbols on the display.
- 2 or 4 analogue outputs with configurable output range. Every output signal can be set freely within the signal limits (see Technical Data). The characteristic curve change can be made in a linear, rooted, tabular or mathematic form proportional to the displayed value.

The unit also has a Modbus interface and can be connected to a Modbus RTU network as a slave. For more information about this topic, please reference the product user manual and the Modbus reference manual.

(<http://www.fischermesstechnik.de/en/downloads/manuals>)

All parameters can also be set on the device via the touch display or (optionally) via a PC software. The measuring value display unit has a USB interface to which a USB stick can be connected. For instance, the USB stick can be used to allow simple configurations to be exported to other devices. The PC software also allows a measuring point protocol ⁽²⁾.

⁽²⁾ parameter profile

3 Installation and assembly

The EA16 is designed for panel installation and is supplied fully assembled. Please see the supplied electro-technology documents for the dimensional drawings and information about the electrical connection of the panel. Panels can always be supplied in the following mounting types.

Wall-mounting

Via a recess in the wall in the clean room. The minimum installation depth is 49 mm. The panel is attached with sunk-head screws.

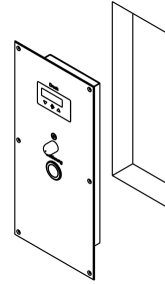

Fig. 2: Wall-mounting

Surface installation

Via surface-mounted housing on the wall of the clean room. The minimum installation depth is 52 mm. The panel is attached to the surface-mounted housing with sunk-head screws.

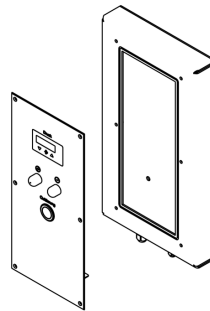

Fig. 3: Surface installation

Channel assembly

Via a cut-out in the channel. The minimum installation depth is 49 mm. The panel is attached with sunk-head screws.

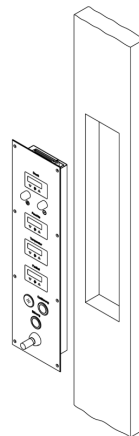

Fig. 4: Channel installation

4 Commissioning

4.1 General

All electrical supply, operating and measuring lines, and the pressure connections must have been correctly installed before commissioning.





NOTICE

Illustrations

All illustrations are examples to demonstrate a certain situation. The contents of the screen may vary greatly on the unit. For instance, the names of the input channels can be freely selected; the status displays for the switch outputs can be hidden and lots more.

Pictogram explanation

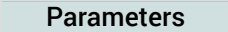
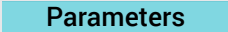
This table explains how the different objects (menu, parameters, etc.) are shown in the text of these operating instructions. Due to modifications to the background colour, the colour of the presentation of some symbols on the screen may vary.

Symbol	Description
Operating keys	
▲	Increasing
◀	Left
↵	OK
▶	right side
▼	decreasing
Esc	Cancel
☑	yes on
☒	N/a Off
	Touch the screen (with your hand or stylus pen), the symbol may be in a different colour
△	Paging symbol
Menu	
	Menu name (button)
	Menu and/or parameter not valid under certain conditions.
File	Parameter name
<Value>	System parameter value
Access Rights	
🔒	No access
🔍	read only
NOTICE! Swipe function	Important comments e.g. only swipe function
	Further left

4.2 Measured value display

There are two options for the measured value display presentation.

- Tile view
- List view

The colour of the individual chapters can be changed depending on the respective input signal. To do this, certain thresholds are configured for each colour in the menu **Colour change**. The associated colours represent the respective operating statuses.

In the list view, the background shadowing and the warning symbol assume the function of the tiles. The colours are controlled depending on the input signal like the tiles.

Depending on the unit model (2-channel/4-channel), there are different presentation variants [▶ 15] for the measured value display.

4.2.1 Tile view

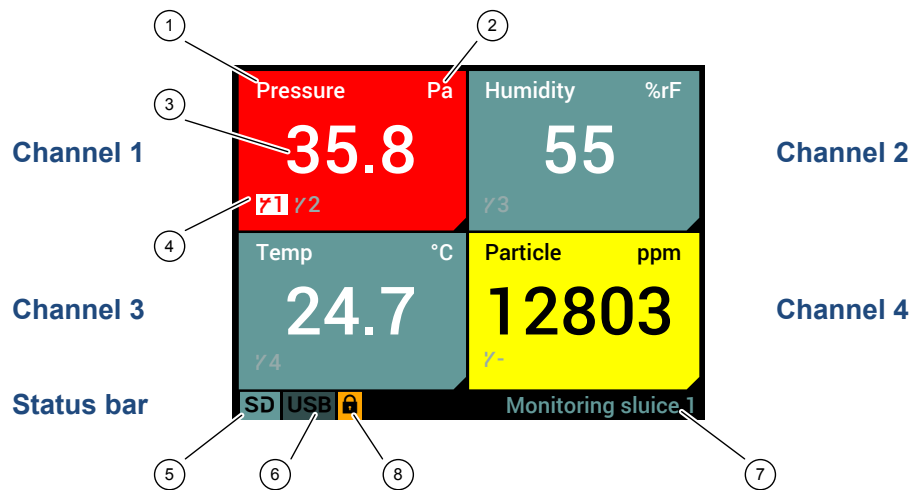

Fig. 5: Measured value display

1	Channel name	2	Einheit
3	Measurement	4	Status switch output
5	Status SD card	6	Status USB
7	Unit designation or Date / Time	8	Login symbol

- γ- No contact assigned
- γ1 Contact switched
- γ1 Contact not switched

Fig. 6: Status display

The example of a switch output demonstrates how the status display works.

1. The symbol for the switch output lights up, if the contact is switched.
2. The backlighting disappears, if the contact is not switched. The contact symbol is shown in grey.

NOTICE! Back lighting

The backlighting colour is usually white. However the backlighting for a yellow tile is black.

In the status displays for the SD card and USB interface, access to the medium is symbolised by orange backlighting. The green backlighting shows that a unit is connected. The backlighting is grey, if no unit is connected.

A logged-in user is shown by the login symbol. If the user is inactive, he will be automatically logged out after a timeout time has expired.

Detail view channel 1

Tip the respective tile to go to the detail view of a channel. Return to the measured value screen in the same way. The following uses the detailed view of the first channel to demonstrate all channels.



Fig. 7: To detail view

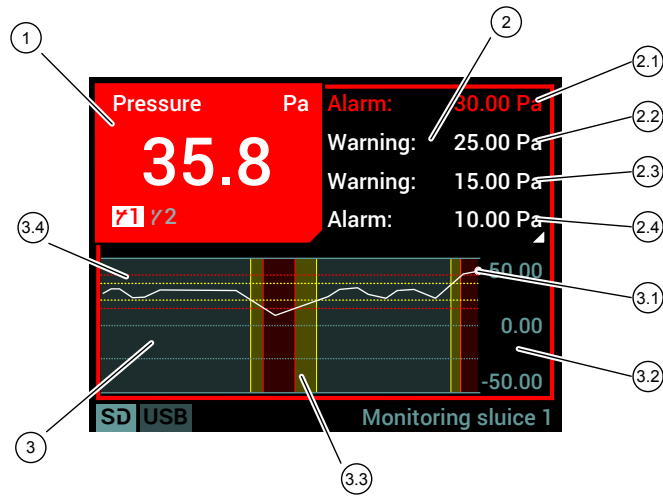

Fig. 8: Detailed view

1	Measurement data display	3	Trend display
2	Status display	3.1	Current measured value
2.1	Alarm: Threshold value high - red	3.2	Measuring range
2.2	Warning: Threshold value high - yellow	3.3	Colour change
2.3	Warning: Threshold value low - yellow	3.4	Limit lines of the thresholds
2.4	Alarm: Threshold value low - red		

Status display

The page symbol \triangleleft shows that there are more screen pages in the status display. Touch anywhere on the status display to show the next page.

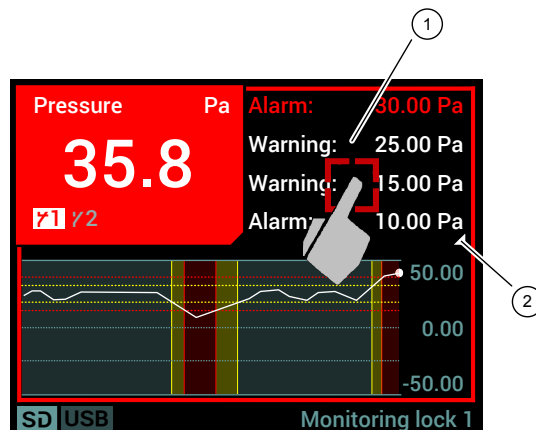

Fig. 9: Status display

1	Status display	2	Paging symbol
---	----------------	---	---------------

The second page of the status display appears. Touch anywhere on the status display to show the next page. At the end, you automatically return to the first page.

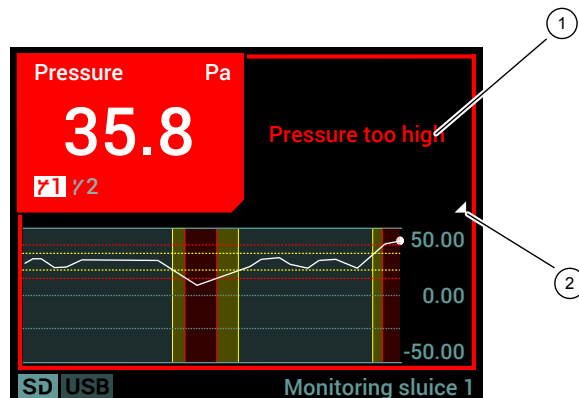

Fig. 10: Detail view alarm message

- | | | | |
|---|------------------------------|---|---------------|
| 1 | Message high - red (input 1) | 2 | Paging symbol |
|---|------------------------------|---|---------------|

4.2.2 List view

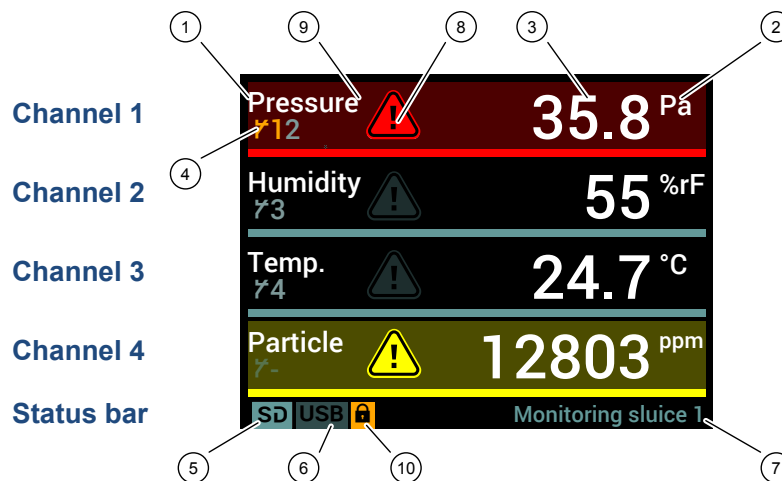

Fig. 11: Measured value display

1	Channel name	2	Einheit
3	Measurement	4	Status switch output
5	Status SD card	6	Status USB
7	Unit designation or Date / Time	8	Warning signs
9	Background shadowing	10	Login symbol



-  No contact assigned
-  Contact switched
-  Contact not switched

Fig. 12: Status display

The example of a switch output demonstrates how the status display works.

1. The symbol for the switch output goes orange, if the contact is switched.
2. The symbol for the switch output goes grey, if the contact is idle.

NOTICE! Back lighting

In the status displays for the SD card and USB interface, access to the medium is symbolised by orange backlighting. The green backlighting shows that a unit is connected. The backlighting is grey, if no unit is connected.

A logged-in user is shown by the login symbol. If the user is inactive, he will be automatically logged out after a timeout time has expired.

Detail view channel 1

Tip the respective list entry to go to the detail view of a channel. Return to the measured value screen in the same way. The following uses the detailed view of the first channel to demonstrate all channels.



Fig. 13: To detail view

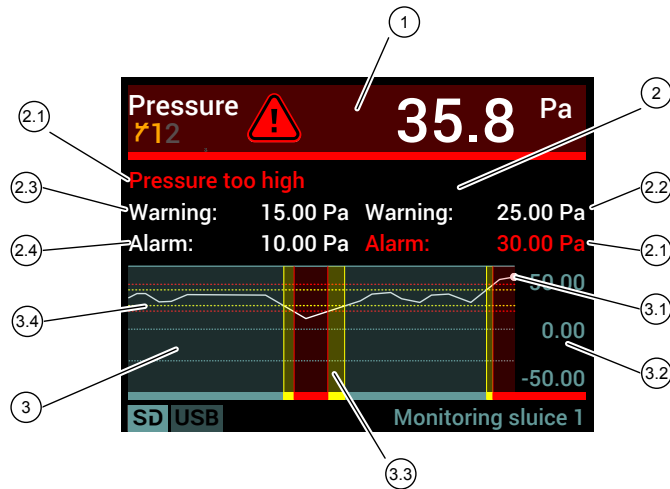

Fig. 14: Detailed view

1	Measurement data display	3	Trend display
2	Status display	3.1	Current measured value
2.1	Alarm: Threshold value high - red	3.2	Measuring range
2.2	Warning: Threshold value high - yellow	3.3	Colour change
2.3	Warning: Threshold value low - yellow	3.4	Limit lines of the thresholds
2.4	Warning: Threshold value low - red		

4.2.3 Presentation variants

The unit is available in a 2-channel and 4-channel version. This setting is made ex-works.

The detail views are identical to the detail views of the 4-channel version.

The analogue inputs on both versions can be switched off individually. This status is indicated by OFF in the respective tile (or list). If two analogue outputs are switched in the 4-channel version, the presentation variant of the 2-channel model is shown on the measured value display.

2-channel tile view

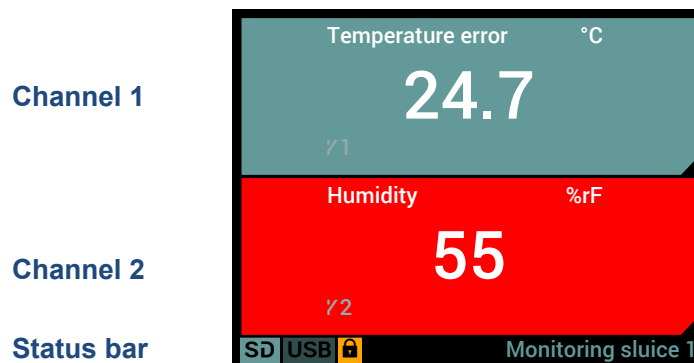

Fig. 15: 2-channel measured value display

2-channel list view

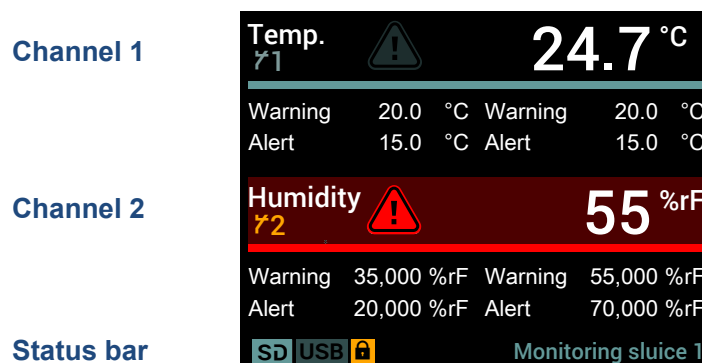

Fig. 16: 2-channel measured value display

4.3 Control elements

The unit is equipped with a TFT Touch LCD colour display. It is operated via a list menu and the input interfaces that depend on the functions.

The touch function is not explained because so many devices have this state-of-the-art function.

We recommend using a stylus pen.

Example: Password input

Touch anywhere on the status bar to go to the menu. The following menu appears on the screen:

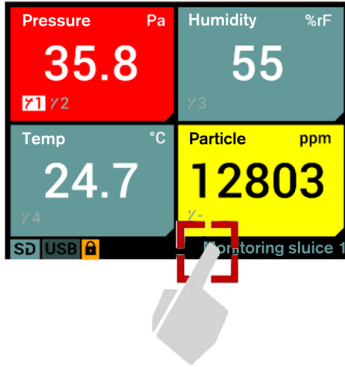

Fig. 17: Menu input

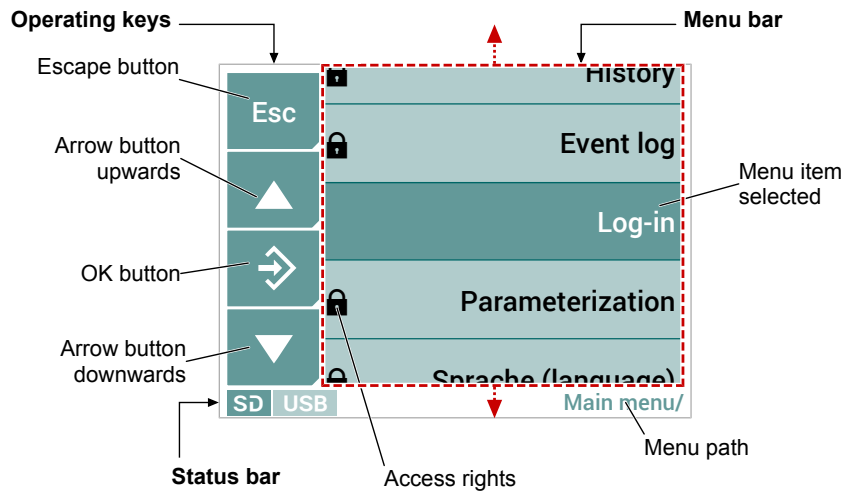

Fig. 18: Main menu

The dotted red line marks the picture section. This can be moved using the arrow keys ▲ ▼, the arrow shows the respective direction.

The menu entry in the centre of the screen is always selected and opened by pressing the OK button ⇨. Alternatively, a menu entry can also be touched to open it.

In this example, the screen opens when a password is entered. The menu path shows where you are in the menu tree.

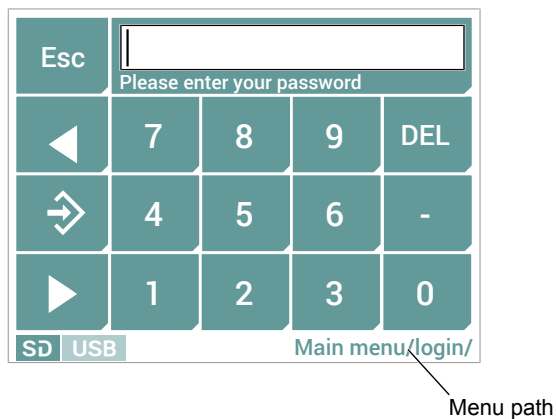

Fig. 19: Main menu/login

Enter the password and complete the input by pressing the OK button ↵. A message appears on the screen stating which user you have logged in with. Once you have acknowledged the message, you return to the main menu.

The following user profiles are used:

User	Rights
View	The user only has read rights for the configuration options.
Expert	The user may change some of the configuration options. The user has no access to the passwords.
Admin	The user may change all the configuration options. However the user only has access to the passwords of the subordinate user levels.
Supervisor	This user has full access to all parameters and passwords.

5 Parameterization

5.1 General Information

The EA16 is a highly complex measured value display with a control system that can be learned intuitively. Due to its complex structure and the possibility of supplementing functions by means of a firmware update, it is not possible to present all functions in details in these operating instructions.

The following describes the basic functions of the unit and how they are used.



NOTICE

Value ranges

The presented value ranges of the parameters correspond to the default values of the factory configuration. If certain parameters are changed (e.g. measuring range), the value ranges of the dependent parameters (e.g. thresholds) are automatically adjusted. For this reason, the actually displayed value ranges may differ from the value ranges shown in these instructions. The latter only serves as a typical example.

5.2 Navigation in the menu tree

The menu can have up to six levels. There are several user profiles with various read/write rights are filed in the user administration. Access to the menus and parameter settings depends on the user.

The menu tree is navigated based on the following scheme:

(a) Level change by direct tapping

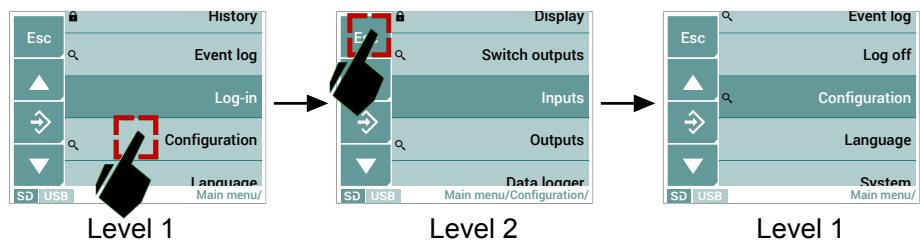

(b) Level change by positioning the screen section

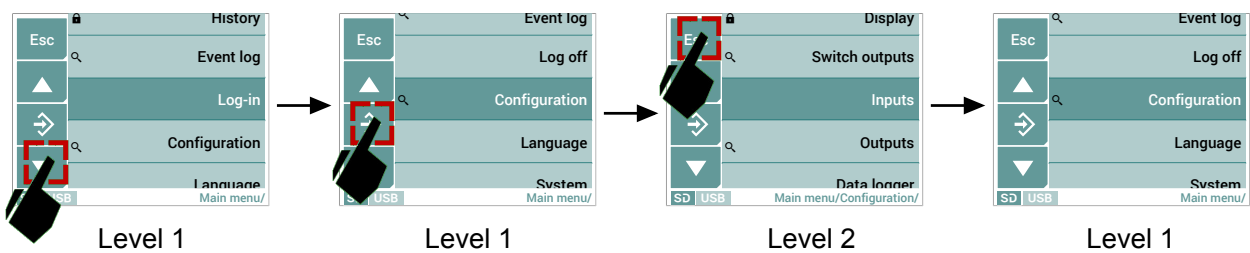

Fig. 20: Navigation menu tree

5.3 Value input

The following provides a description of the input interfaces that are used to enter the values. A differentiation is made between the input of numbers and the input of texts. The screens shown are examples only and may vary in terms of their layout and presentation.

Their functionality can be learned intuitively and is always based on the same principle.

5.3.1 Input of number values

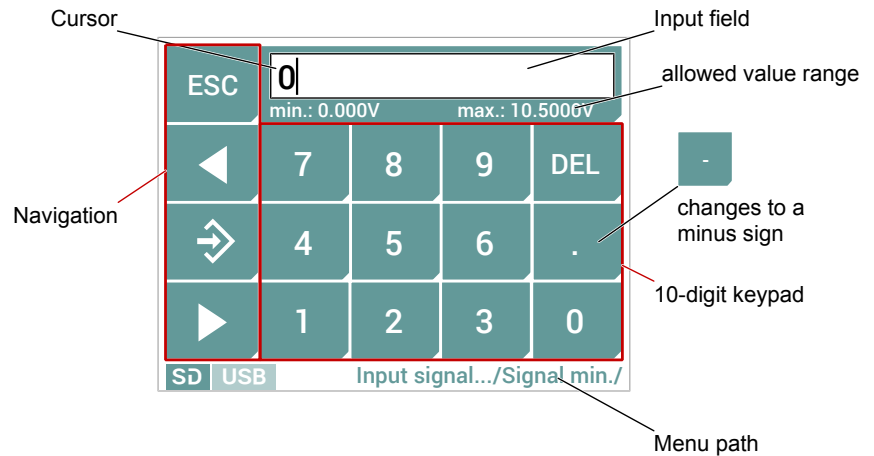

Fig. 21: Number input

Negative integers can be entered by deleting the number value (0 in the example) in the display. The decimal point then changes to a minus sign and can be used.

5.3.2 Text input

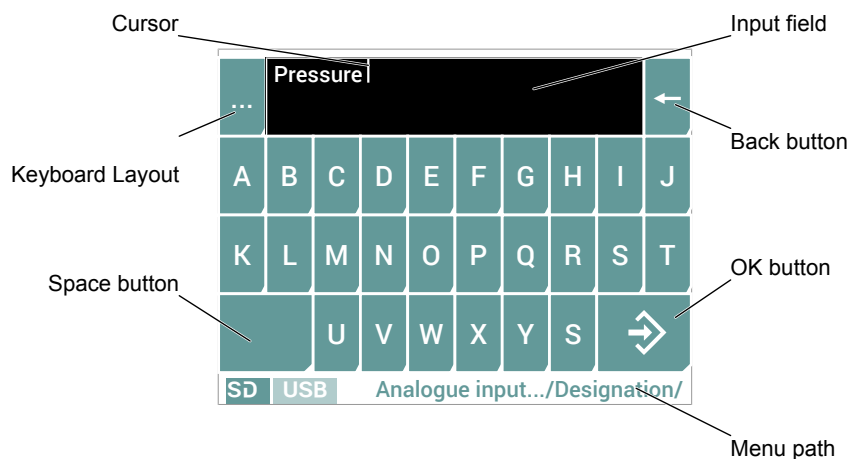

Fig. 22: Text input

The key ... is used to change the assignment of the key pad, and lower case letters, numbers and special characters can be used.

5.3.3 Select parameter values

Some inputs are made by selecting defined parameter values. This occurs either by switching the button or by selection from a list.

Changeover button

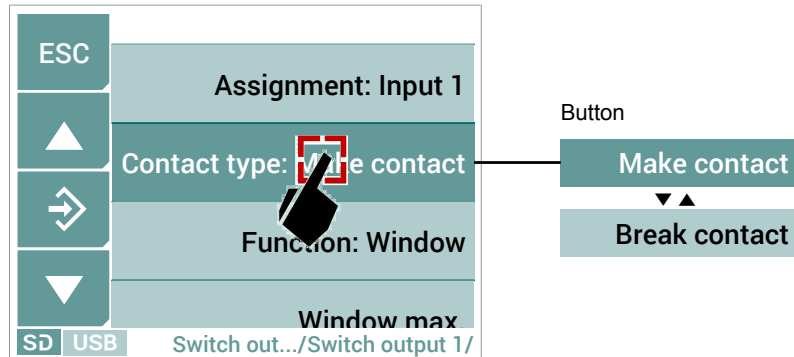

Fig. 23: Select parameter values

Touch the button to change the parameter value. The set value is saved with the button ⇄.

Selection list

Touch the button to open the parameter. A screen as shown appears.

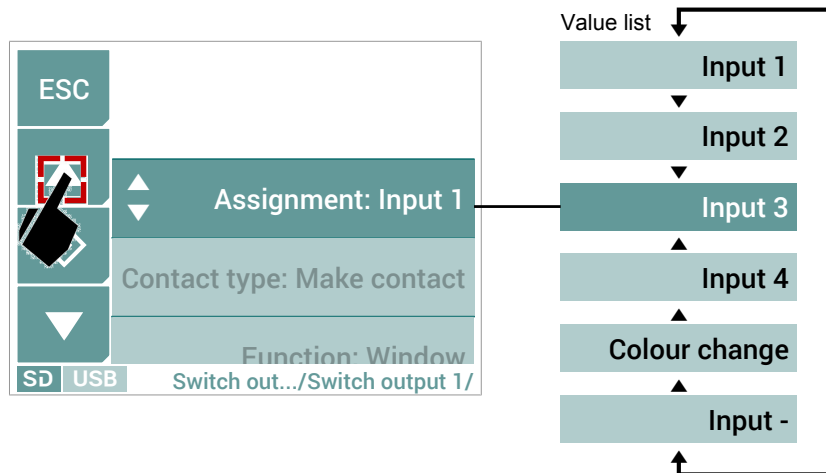

Fig. 24: Select parameter values

You can navigate the value list using the buttons ▲ and ▼. The set value is saved with the button ⇄.

5.3.4 Dialogue box

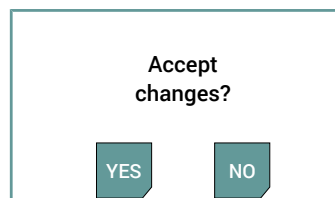

Fig. 25: Dialogue box

This or a similar dialogue box appears, if the user needs to confirm something. Parameter changes are accepted after they have been confirmed with Yes, and are logged in the activated event log. If rejected with NO, the changes are cancelled.

5.4 Main menu [Level 1]

Menu path: Main menu/

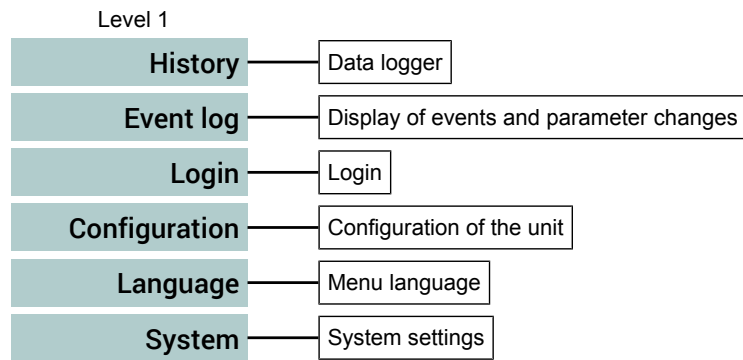
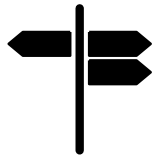

Fig. 26: Main menu [Level 1]

Signpost [▶ Page]



Menu: Hystory [Level 2] [▶ 22]
Menu: Event log [Level 2] [▶ 29]
Menu: Log on/Log off [Level 2] [▶ 30]
Menu: Configuration [Level 2] [▶ 31]
Menu: Language [Level 2] [▶ 76]
Menu: System [Level 2] [▶ 76]

5.4.1 Menu: History [Level 2]

Menu path: Main menu/History/

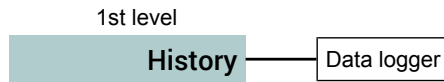

Fig. 27: Menu: History

The recorded measured values are presented in a chart in this menu. There is a wide range of functions available to analyse the data.

5.4.1.1 Graphic display

The measured values are saved on the micro SD card according to the setting in the menu Data Logger [▶ 72]. This saved data can be presented graphically in the History menu. Generated data is used to explain the graphic display.

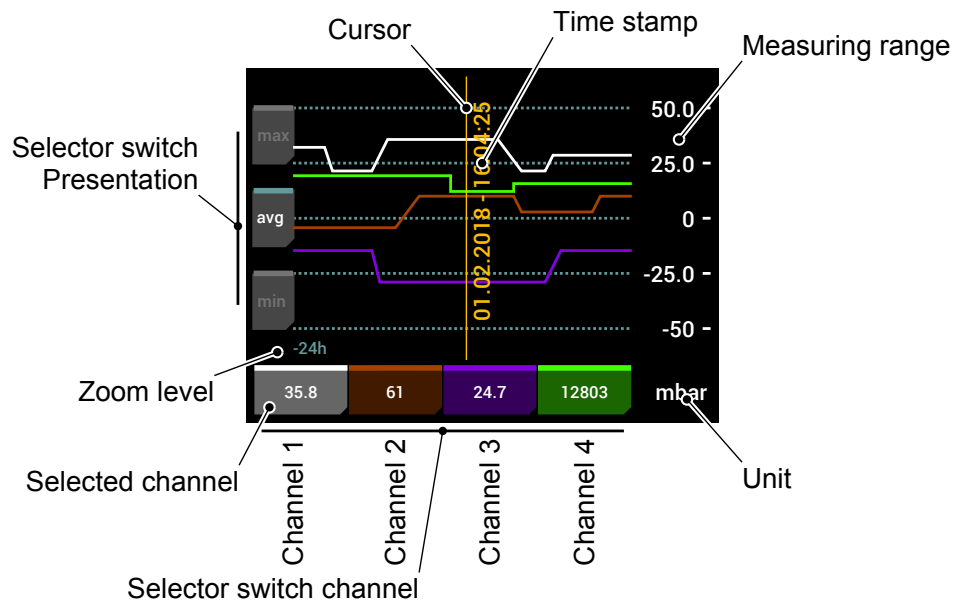

Fig. 28: Graphic display

The following functions are available in the graphic display

- **Presentation or measurements**
Using the presentation tiles **max**, **avg** and **min** the presentation type of the measurements can be changed.
- **Channel selection**
The channel is selected with the channel tile on the bottom edge of the screen. The measuring range belonging to the channel and the unit are shown on the right edge of the screen. The selected channel is shown in a white colour.
- **Cursor**
The cursor is used to select a specific point in time. The measurements of the channels at this time are shown on the associated channel tile.
- **Circular menu**
If the screen is touched at any point, the circular menu with other functions appears.



Fig. 29: Circular menu

5.4.1.1.1 Pres. of measurement.

When presenting the measurements, you can choose between three options:

max

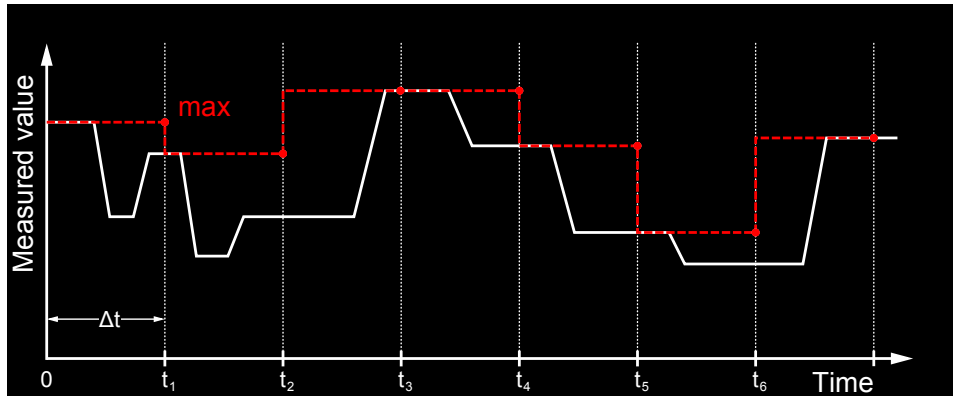

Fig. 30: Presentation of measurements (maximum values)

The maximum value that occurred will be shown in the respective time interval Δt.

avg

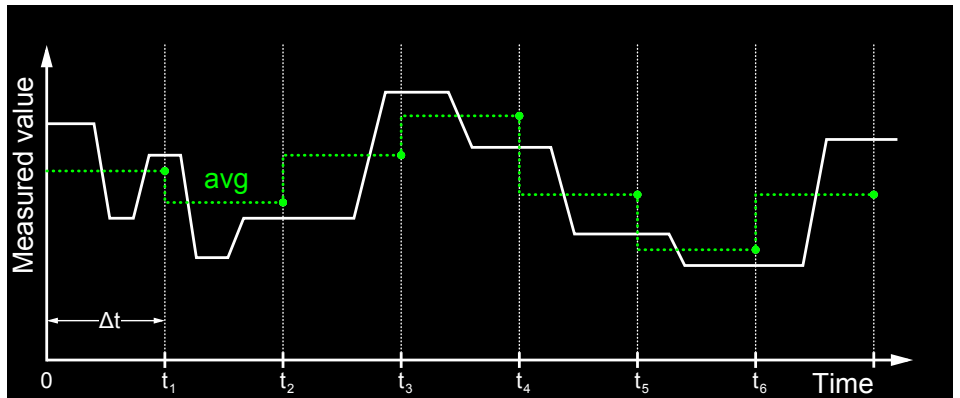

Fig. 31: Presentation of measurements (average values)

The average value that occurred will be shown in the respective time interval Δt.

$$\text{avg} = \frac{\text{Sum of measured values } (\Delta t)}{\text{Number of measured values } (\Delta t)}$$

min

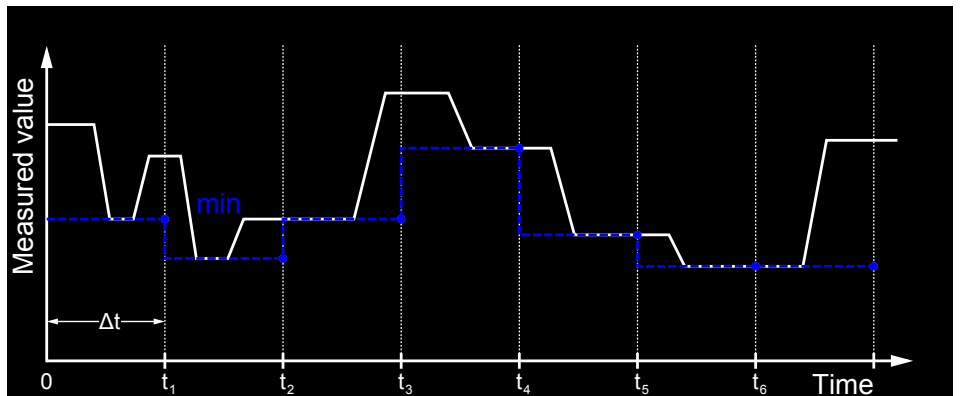

Fig. 32: Presentation of measurements (minimum values)

The minimum value that occurred will be shown in the respective time interval Δt.

5.4.1.1.2 Channel selection

Channel change

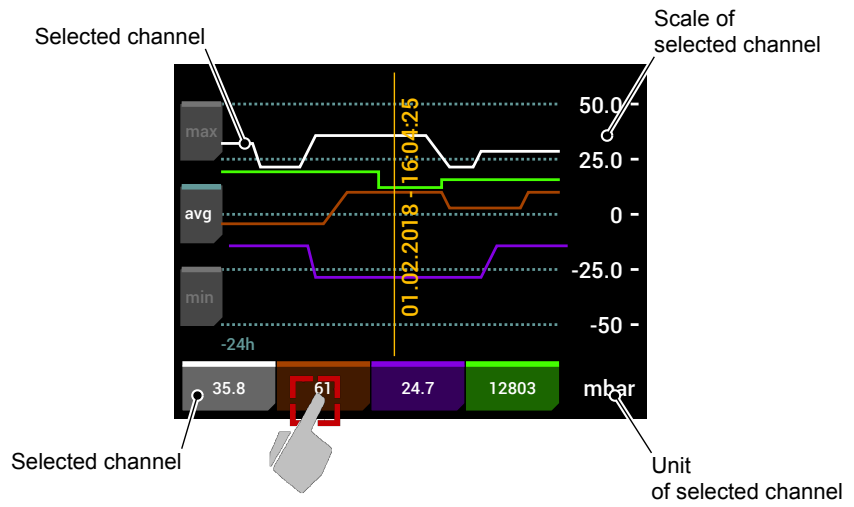

Fig. 33: Graphic display channel selection

Each channel is assigned to a colour. The white colour marks the selected channel for which the unit and scale are shown. The channel is changed by touching the colour-assigned channel on the lower edge of the screen.

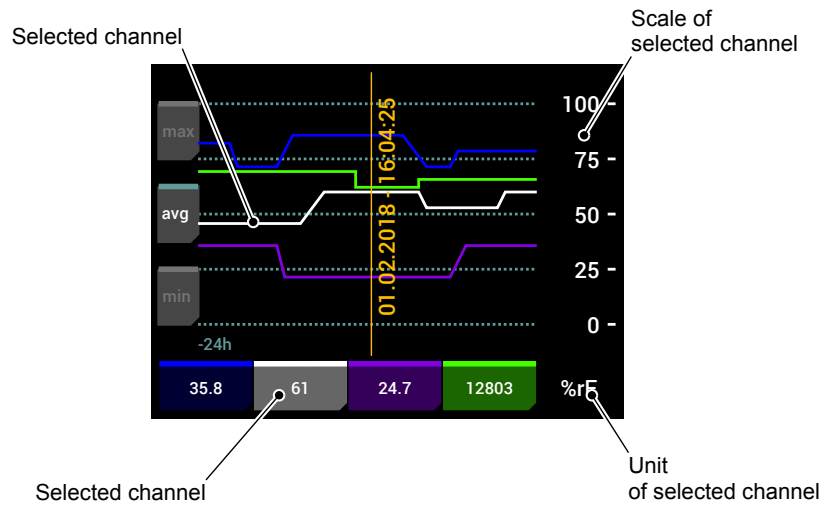

Fig. 34: Graphic display selected channel

Detailed presentation

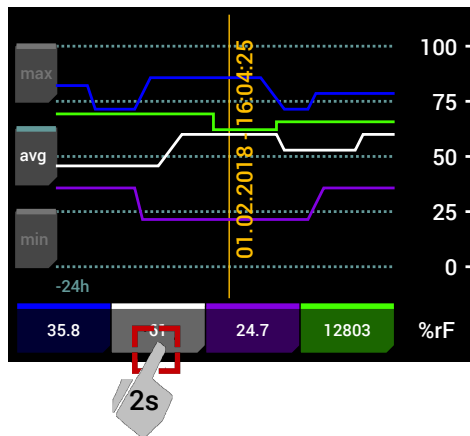

Fig. 35: Graphic display to change to the detailed presentation

A longer touch on the channel tile changes the display into the detailed presentation for this channel.

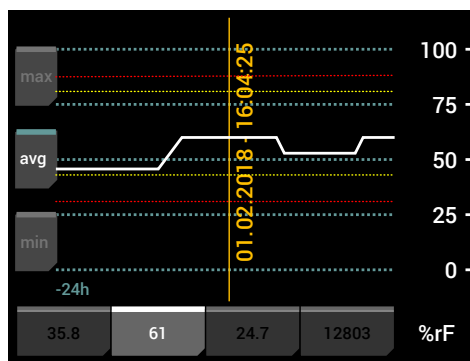

Fig. 36: Graphic display detailed presentation

The colour change thresholds are shown. All other channels are hidden. The channel change is carried out in the same way as described above

Touch anywhere on the screen to return to the graphic display of all channels.

5.4.1.1.3 Cursor

The cursor is shown as a vertical line. If this line is touched, a time stamp appears on the right (date + time).

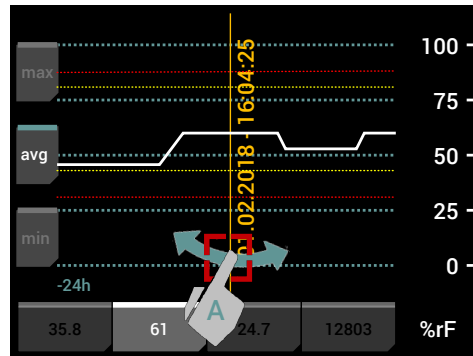

Fig. 37: Graphic display swipe

Swiping left or right moves the cursor. The line follows the movement until the new position is reached. The associated measurement is shown on the tile.

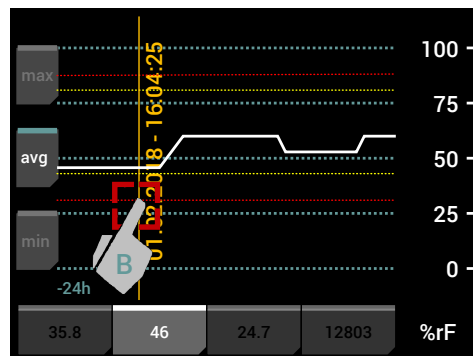

Fig. 38: Graphic display move cursor

Alternatively, the cursor can also be moved by means of a longer touch on a certain point of the screen.

5.4.1.1.4 Circular menus

The so-called circular menu is a context menu that offers various functions for navigation and presentation of the historical data.

Touch any point on the display to call up the circular menu.

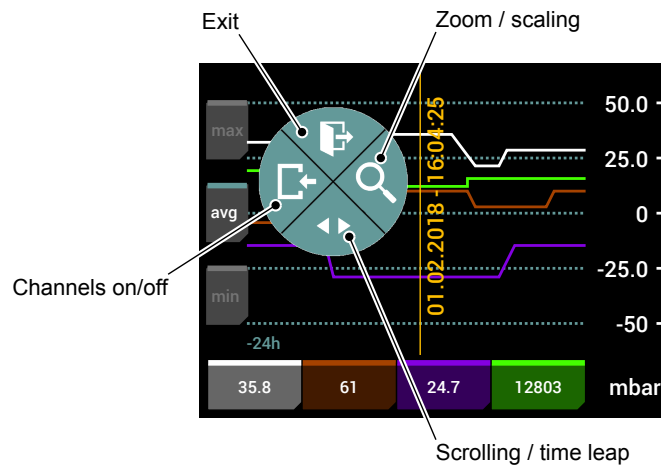

Fig. 39: Graphic display circular menu start

Sub menu: Channels on/off

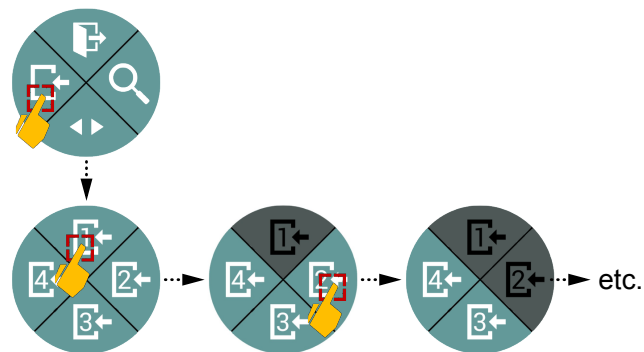

Fig. 40: Sub menu: Channels on/off

Touch the left-hand segment of the circle to enter the submenu Channels On/OFF. From here you can touch the segments of the circle to switch off the assigned input channel. In the graphic display, the measurement curve is no longer shown and the channel tile is greyed out.

Touch somewhere outside the circle submenu to return to the circle main menu.

Submenu: Channels zoom / scaling

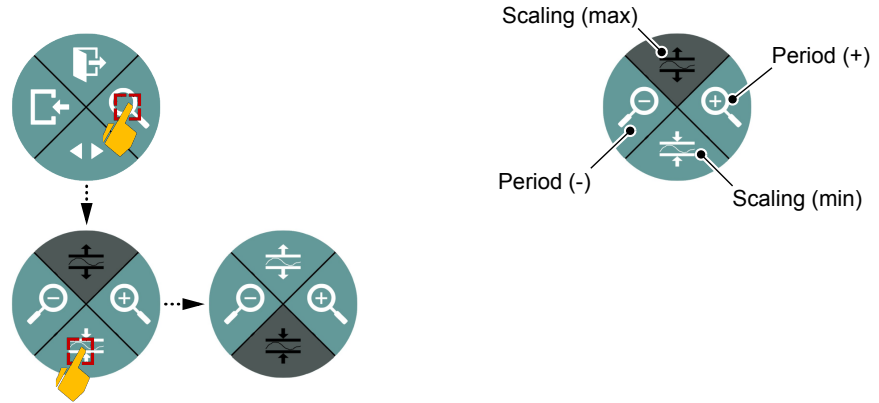

Fig. 41: Submenu: Channels zoom / scaling

Touch the right segment of the circle to enter the submenu: Channels zoom / scaling. This is where you can set the time and value range for the presentation of the saved data.

The shown period is set to 2, 4, 8, 12 and/or 24 hours with the buttons and . The value range is scaled with the buttons and .

Touch somewhere outside the circle submenu to return to the circle main menu.

Submenu: Set channel period

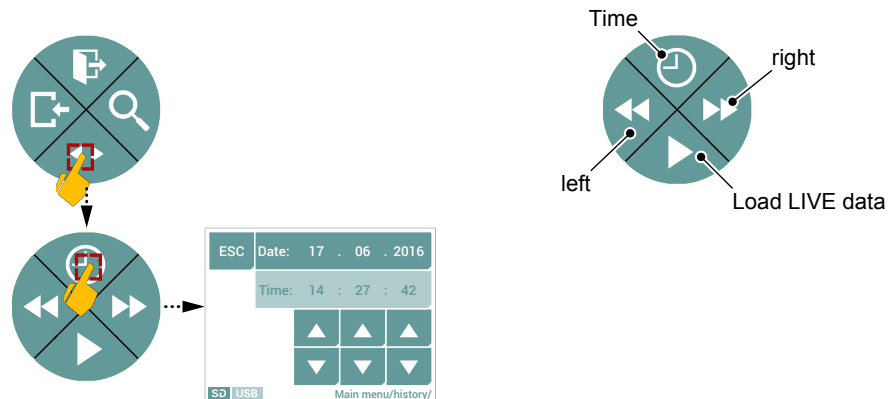

Fig. 42: Submenu: Set channel period

This menu is used to set the data for a specific period. The time axis can be scrolled using the arrow keys. The button is used to load the data at the actual time (LIVE data).

Touch somewhere outside the circle submenu to return to the circle main menu.

5.4.2 Menu: Event log [Level 2]

Menu path: Main menu/Event log/

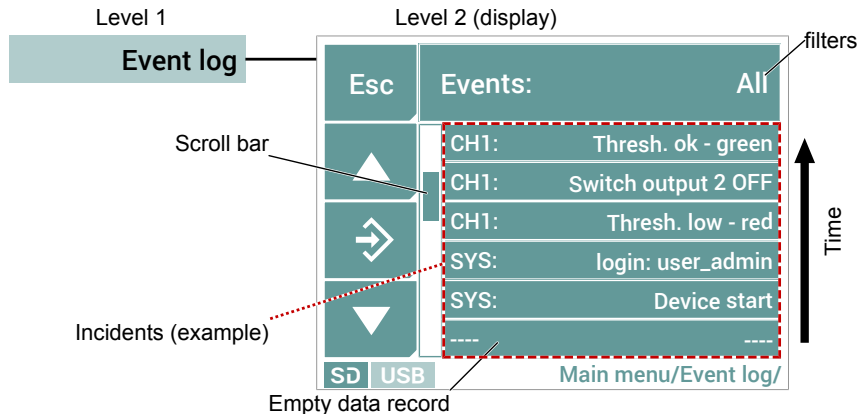

Fig. 43: Menu: Event log

A filter can be used to select which type of event should be shown. The respectively active filter is shown in the title line. The following settings are possible for the filter:

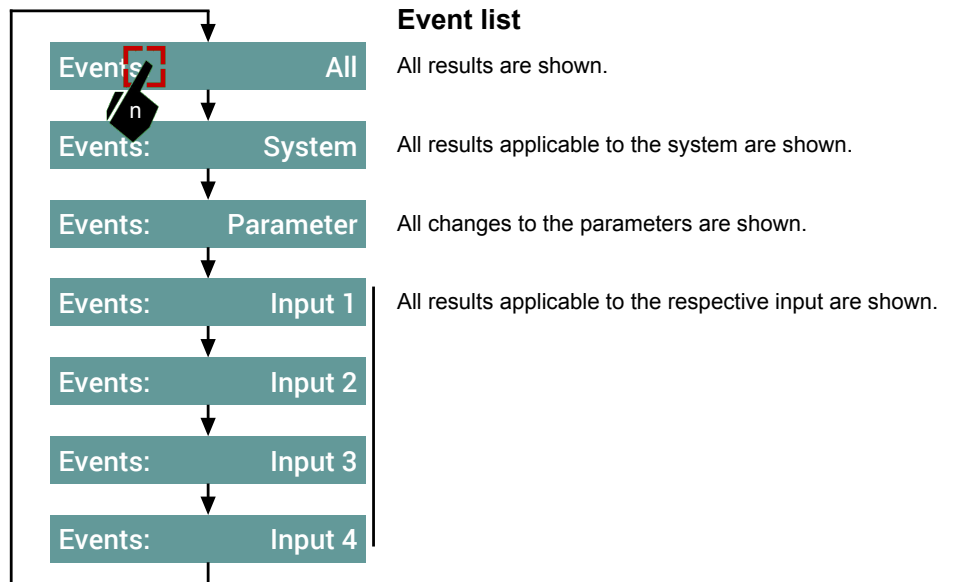

Fig. 44: Navigation filter

A certain filter is selected by repeatedly (x-times) touching the title line.

The event list is shown depending on the filter presentation. An event list comprises max. 30 data records. 6 data records each form a screen page. The entire page memory therefore comprises 5 pages. A scroll bar indicates what page you are on within the page memory. The page memory can be navigated using the arrow keys ▲ ▼.

An event can be called up by touching it. The dialogue box that appears provides more information about the event and also an option to allow graphic display.

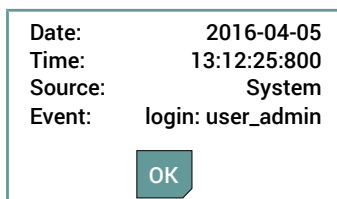

Fig. 45: Example dialogue box

5.4.3 Menu: Log on / log off [Level 2]

Login

Menu path: Main menu/Login/

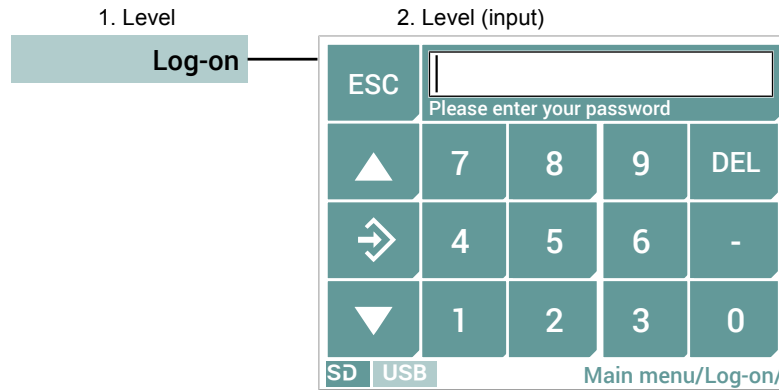

Fig. 46: Menu: Login

Enter the password and complete the input by pressing the OK button ↵. A message appears on the screen stating which user you have logged in with. Once you have acknowledged the message, you return to the main menu.

Now the button 'Log-off' appears.

Log off

Menu path: Main menu/Login/

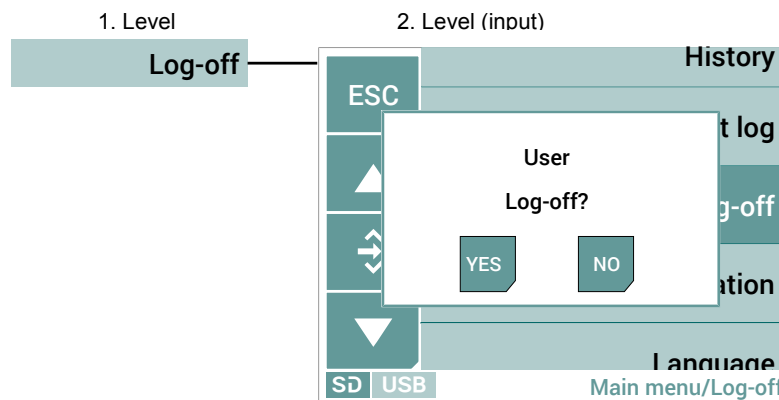

Fig. 47: Menu: Log off

To log-off, simply press the corresponding button. A message appears on the screen with which the user can log out.

NOTICE! After the expiry of a certain time period without activity, the user is automatically logged off.

This time period is defined with the parameter **Log off after** in the Display menu.

5.4.4 Menu: Configuration [Level 2]

Menu path: Main menu/Configuration//

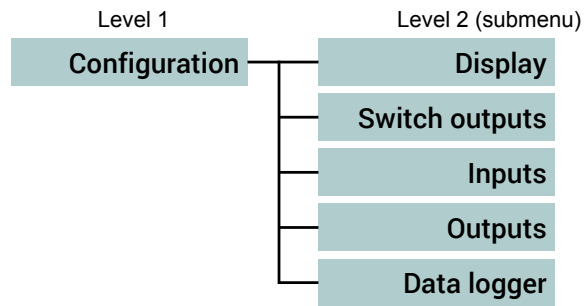
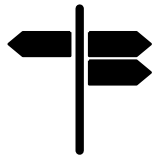

Fig. 48: Menu Configuration

Signpost [▶ Page]



Menu: Display [Level 3] [▶ 32]
Menu: Switch outputs [Level 3] [▶ 33]
Menu: Inputs [Level 3] [▶ 40]
Menu: Outputs [Level 3] [▶ 68]
Menu: Datalogger [Level 3] [▶ 72]

5.4.4.1 Menu: Display [Level 3]

Menu path: Main menu/Configuration/Display/

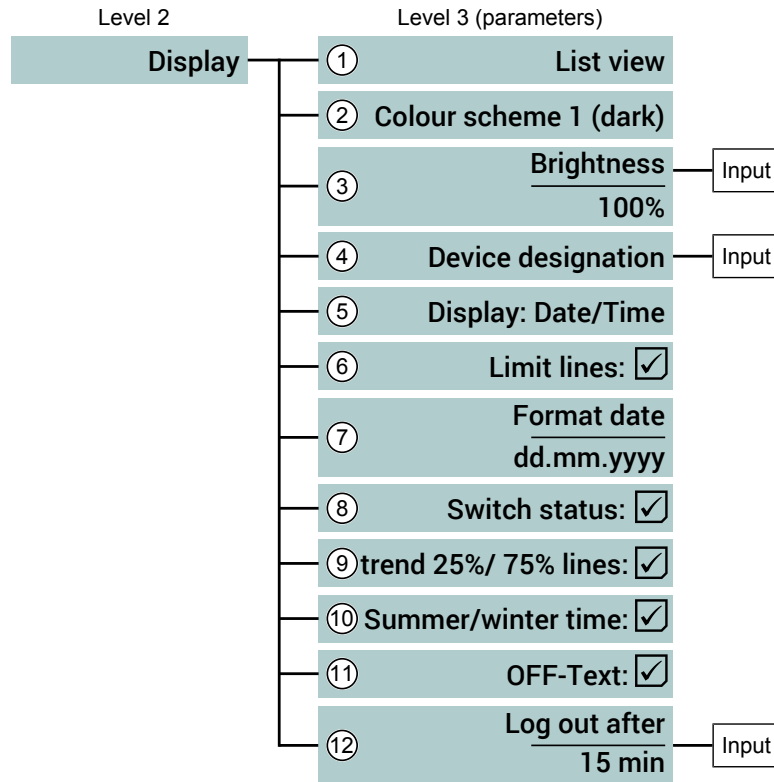

Fig. 49: Menu Display (Example)

Item	Value range	Description
1	List view Tile view	The presentation type of the display is selected with this parameter.
2	Colour scheme 1 (dark) Colour scheme 2 (light)	The design of the display is selected with this parameter.
3	Brightness 30% ... 100%	The display brightness can be set in 10% steps with this parameter. The setting has an immediate impact on the display.
4	Device designation 0 ... 29 characters	Any sequence of characters can be used for the unit designation. Please note that the presentation is limited by the space available in the status line.
5	Display: Date/Time Display: Designation	This parameter defines what is shown in the status line.
6	Limit lines <input checked="" type="checkbox"/> Yes (standard value) <input checked="" type="checkbox"/> No	This parameter defines whether the set limit values are shown in the detail view.
7	Format Date dd.mm.yyyy	The date format is set with this parameter.
8	Switch status <input checked="" type="checkbox"/> Yes (standard value) <input checked="" type="checkbox"/> No	This parameter defines whether the status of the switch outputs in the operating display should be shown.
9	trend 25%/ 75% lines <input checked="" type="checkbox"/> Yes (standard value) <input checked="" type="checkbox"/> No	This parameter defines whether or not the trend lines at 25% and 75% of the input signal should be shown.

5.4.4.2 Menu: Switch outputs [Level 3]

Menu path: Main menu/Configuration/Switch outputs/

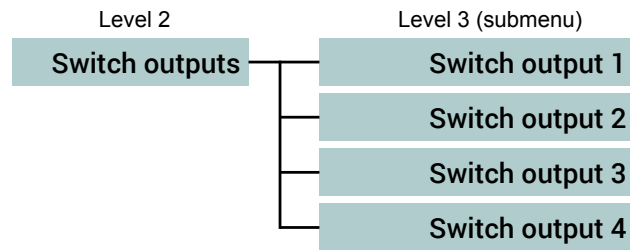

Fig. 50: Menu Switch outputs

All switch outputs are configured in the same way. Therefore the associated parameters are explained below using the example of switch output 1.

Menu: Switch output 1 [Level 4]

The switch outputs can be assigned to both the input signals and also the colour changes. Depending on the selected assignment, the following submenu also changes.

A. Assignment to the input signals

Menu path: Main menu/Configuration/Switch outputs/Switch output 1

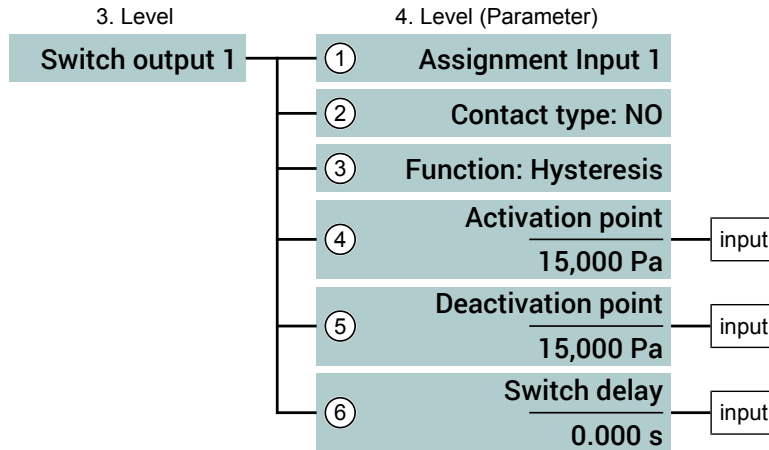

Menu Switch output 1 (Assignment: Input signals)

Pos.	Value range	Description
1	Assignment Input: 1 Assignment Input: 2 Assignment Input: 3 Assignment Input: 4 Assignment: Colour change Assignment Input: -	This parameter assigns switch output 1 to an input (1...4) or switches it off (-).
2	Contact type: Make contact Contact type: Open contact	This parameter defines whether or not the switch output 1 works with an open contact or make contact.

The parameter list changes depending on the parameter **function**:

Hysteresis

3	Function: Hysteresis	Hysteresis function
4	Switch-on point	An input window opens. The possible input limit values depend on the set measuring range.
5	Switch-off point	An input window opens. The possible input limit values depend on the set measuring range.

Window

3	Function: Window	Window function
4	Window max.	An input window opens. The possible input limit values depend on the set measuring range.
5	Window min.	An input window opens. The possible input limit values depend on the set measuring range.
6	Switch delay 0 = OFF 0.01 ... 10800 s	A switch delay of the switch output can be defined in 10 ms steps with this parameter.

Hysteresis function

Key: _____

- Input signal
- Measuring range
- Increasing input signal
- ← Decreasing input signal

- ⌘ **NO: Make contact**
- Contact closed
- Contact open

- ⌘ **NC: Break contact**
- Contact open
- Contact closed

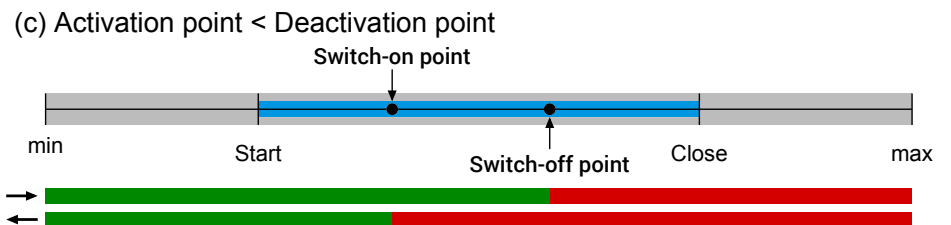
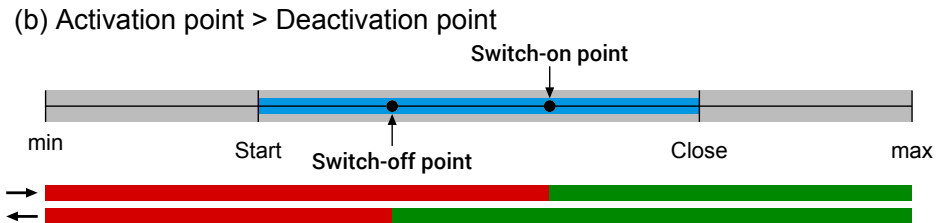
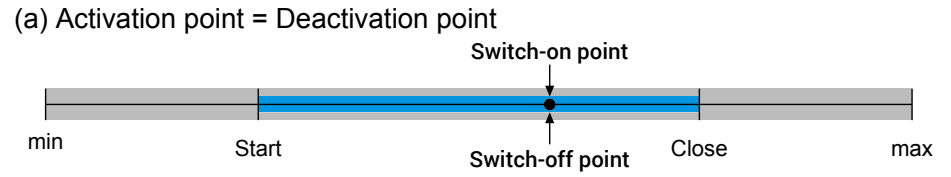

Fig. 51: Hysteresis function

Window function

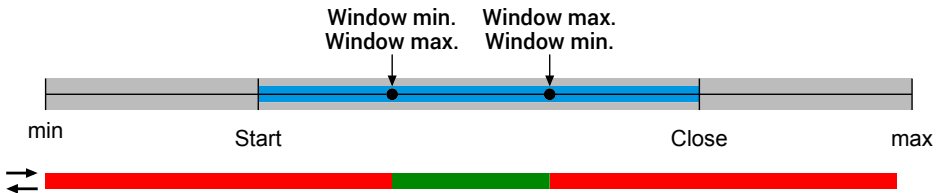

Fig. 52: Window function

B. Assignment to the colour changes

Menu path: Main menu/Configuration/Switch outputs/Switch output 1

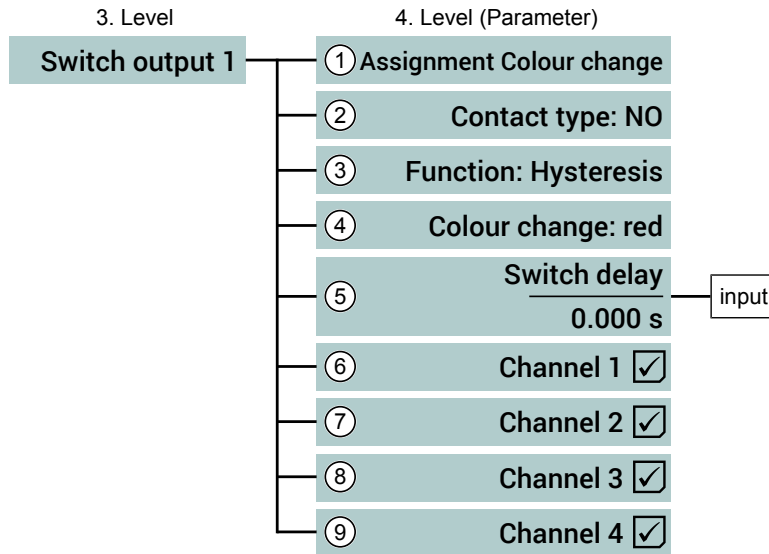

Fig. 53: Menu Switch output 1 (Assignment: Colour change)

Pos.	Value range	Description
1	Assignment Input: 1 Assignment Input: 2 Assignment Input: 3 Assignment Input: 4 Assignment: Colour change Assignment Input: -	This parameter is used to assign the switch output 1 to a colour change
2	Contact type: Make contact Contact type: Open contact	This parameter defines whether or not the switch output 1 works with an open contact or make contact.
3	Function: Hysteresis Function: Window	Hysteresis function Window function
4	Colour-change: red Colour-change: yellow	This parameter is used to define which colour change the switch output responds to.
5	Switch delay 0 = OFF 0.01 ... 10800 s	A switch delay of the switch output can be defined in 10 ms steps with this parameter.
6	Channel 1 <input checked="" type="checkbox"/> Yes <input checked="" type="checkbox"/> No	These parameters can be used to set whether or not the colour change of the respective channels should be monitored.
7	Channel 2 <input checked="" type="checkbox"/> Yes <input checked="" type="checkbox"/> No	
8	Channel 3 <input checked="" type="checkbox"/> Yes <input checked="" type="checkbox"/> No	
9	Channel 4 <input checked="" type="checkbox"/> Yes <input checked="" type="checkbox"/> No	

Traffic light function

The so-called 'traffic light' function is activated by setting the parameter **Assignment colour change**. It serves to control external signalers by a switch output depending on the colour change of the measuring value display.

The parameter channel 1 to channel 4 can set whether or not the respective switch output should respond to the colour change of a certain channel or all channels.

Example1:

External signaler for colour-change 'red' to channel 1

- A signal lamp is connected to contact K1 (switch output 1) and should shine if the colour of the first channel changes to red.

The switching thresholds are defined when configuring the analogue input 1.

Parameter	Switch input 1
Assignment:	Colour change
Contact type	Make contact
Function:	Window
Colour change:	red
Switching delay:	0 sec
Channel 1	<input checked="" type="checkbox"/>
Channel 2	<input type="checkbox"/>
Channel 3	<input type="checkbox"/>
Channel 4	<input type="checkbox"/>

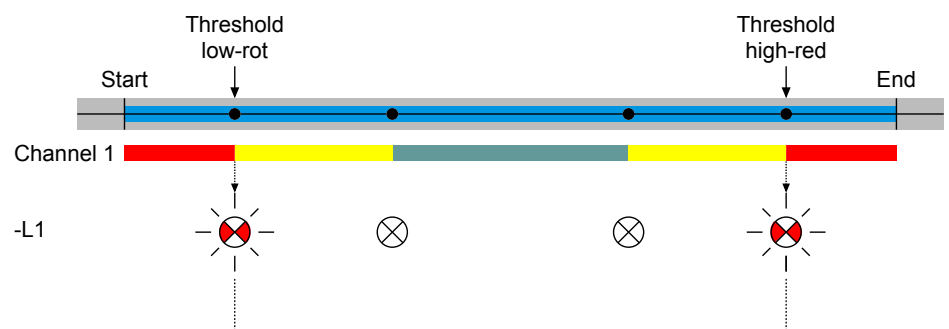
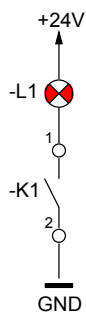

Fig. 54: Example signaler channel 1

If all channels are selected, the signal lamp shines as soon as one of the monitored channels 1 to 4 switches to red.

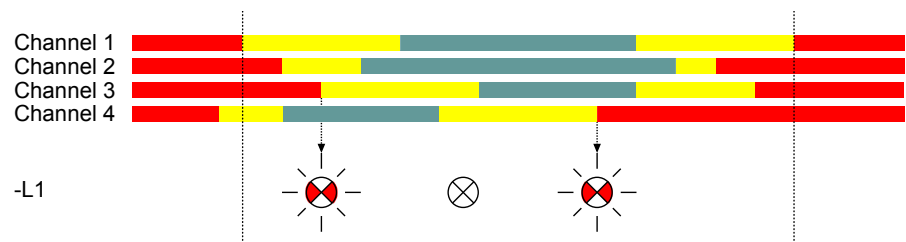

Fig. 55: Example signaller all channels

Example2:

External signaler for colour-change 'red' and 'yellow' to channel 1

- A signal lamp is connected to contact K1 (switch output 1) and should shine if the colour of the first channel changes to red.
- A second signal lamp is connected to contact K2 (switch output 2) and should shine if the colour of the first channel changes to yellow.

The switching thresholds are defined when configuring the analogue input 1.

Parameter	Switch input 1	Switch input 2
Assignment:	Colour change	Colour change
Contact type	Make contact	Make contact
Function:	Window	Window
Colour change:	red	yellow
Switching delay:	0 sec	0 sec
Channel 1	<input checked="" type="checkbox"/>	<input checked="" type="checkbox"/>
Channel 2	<input type="checkbox"/>	<input type="checkbox"/>
Channel 3	<input type="checkbox"/>	<input type="checkbox"/>
Channel 4	<input type="checkbox"/>	<input type="checkbox"/>

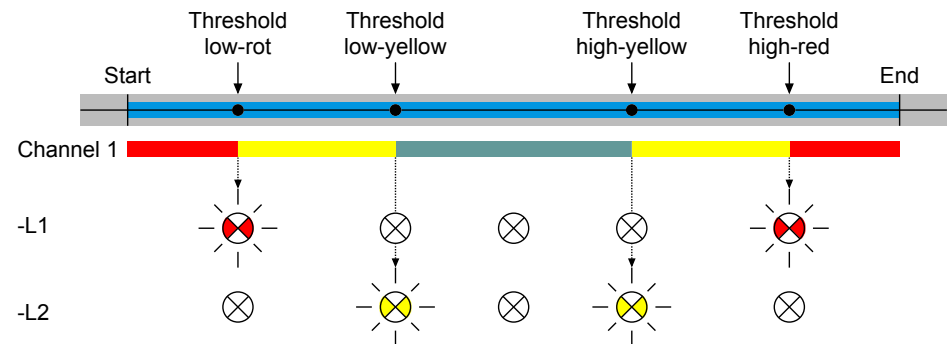
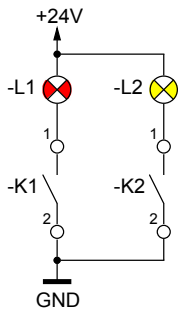

Fig. 56: Example two signallers channel 1 (window function)

The window function was used in this example. However, the contacts switch as follows for the hysteresis function:

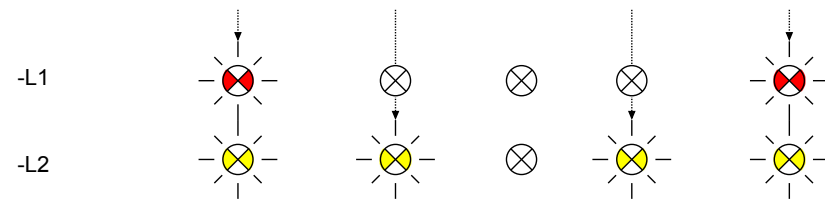

Fig. 57: Example two signaler channel 1 (hysteresis function)

Example3:

External signaller for colour-change 'red', 'yellow' and 'green' to channel 1

- A signal lamp is connected to contact K1 (switch output 1) and should shine if the colour of the first channel changes to red.
- A second signal lamp is connected to contact K2 (switch output 2) and should shine if the colour of the first channel changes to yellow.
- A third signal lamp is connected to contact K3 and should shine if the colour (green) is not changed.

The switching thresholds are defined when configuring the analogue input 1.

Parameter	Switch input 1	Switch input 2	Switch input 3
Assignment:	Colour change	Colour change	Colour change
Contact type	Make contact	Make contact	Break contact
Function:	Window	Window	Window
Colour change:	red	yellow	yellow
Switching delay:	0 sec	0 sec	0 sec
Channel 1	<input checked="" type="checkbox"/>	<input checked="" type="checkbox"/>	<input checked="" type="checkbox"/>
Channel 2	<input type="checkbox"/>	<input type="checkbox"/>	<input type="checkbox"/>
Channel 3	<input type="checkbox"/>	<input type="checkbox"/>	<input type="checkbox"/>
Channel 4	<input type="checkbox"/>	<input type="checkbox"/>	<input type="checkbox"/>

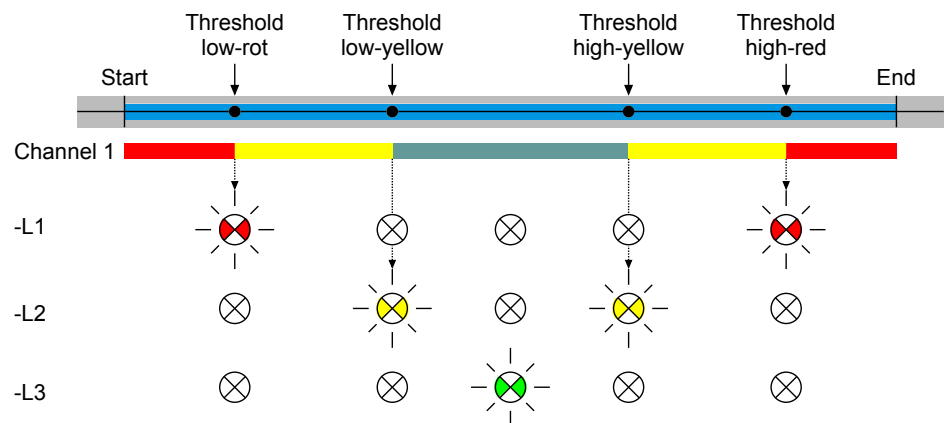
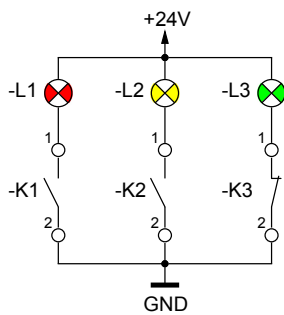

Example three signallers channel 1 (window function)

5.4.4.3 Menu: Inputs [Level 3]

Menu path: Main menu/Configuration/Inputs/

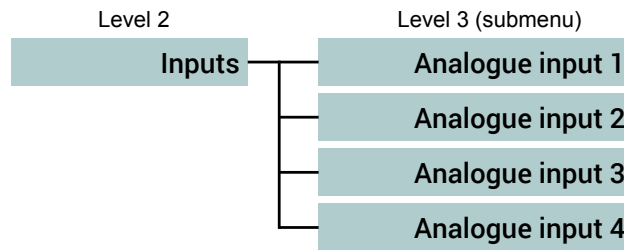

Fig. 58: Menu: Inputs

All analogue inputs are configured in the same way. Therefore the associated parameters are explained below using the example of Analogue input 1.

Menu: Analogue input 1 [Level 4]

Menu path: Main menu/Configuration/Inputs/Analogue input 1

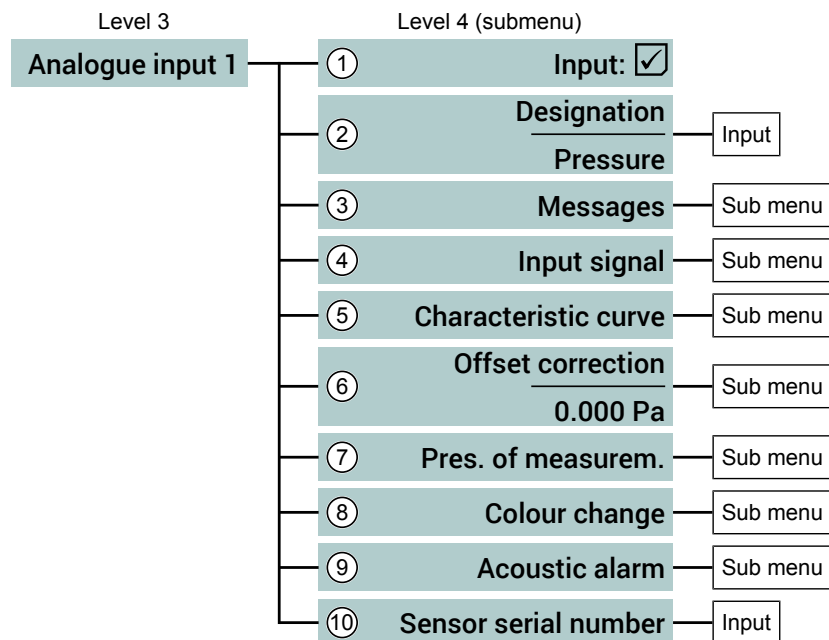

Fig. 59: Menu Analogue input 1

Signpost [▶ Page]



Submenu: Messages [Level 5] [▶ 42]
Submenu: Input signal [Level 5] [▶ 43]
Submenu: Characteristic curve [Level 5] [▶ 43]
Submenu: Offset correction [Level 5] [▶ 61]
Submenu: Pres. of measurem. [Level 5] [▶ 61]
Submenu: Colour change [Level 5] [▶ 62]
Submenu: Acoustic alarm [Level 5] [▶ 65]

Pos.	Value range	Description
1	Input <input checked="" type="checkbox"/> Active (standard value) <input checked="" type="checkbox"/> Inactive	The respective analogue input can be deactivated with this parameter.
2	Designation Pressure	Designation is entered (e.g. pressure) that should appear on the measured value display.
3	Messages	The messages that are dependent on the colour change are issued in this submenu.
4	Input signal	The signal type and input signal range are set in this submenu.
5	Characteristic curve	The characteristic curve parameters are defined in this submenu.
6	Offset correction	An offset correction can be carried out in this submenu.
7	Pres. of measurem.	The integer and decimal places are defined in this submenu.
8	Colour change	The limit thresholds for the colour change are defined in this submenu.
9	Acoustic alarm	The limit thresholds for the alarm are defined in this submenu.
10	Sensor serial number	Entry of the serial number of the connected sensor.

Input: Designation [Level 5]

Menu path: Main menu/Configuration/Inputs/Analogue input 1/Designation/

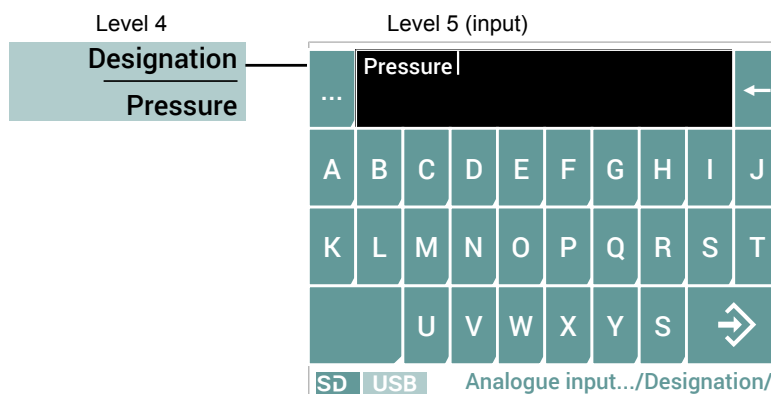

Fig. 60: Input: Designation

Submenu: Messages [Level 5]

Menu path: Main menu/Configuration/Inputs/Analogue input 1/Messages

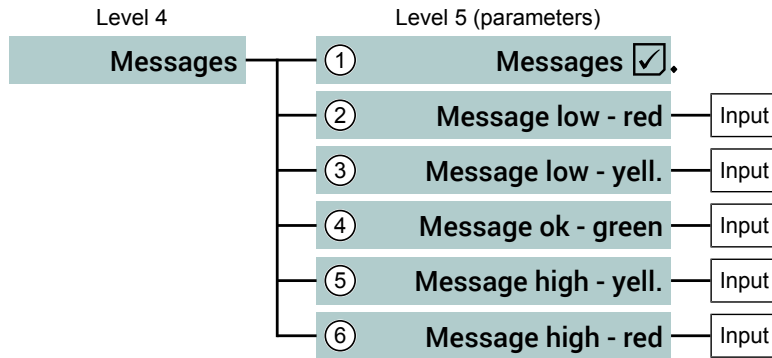

Fig. 61: Menu: Messages

Item	Value range	Description
1	Messages <input checked="" type="checkbox"/> Yes (standard value) <input type="checkbox"/> No	This parameter defines whether or not status messages for the applicable input should be shown on the operating display.
2	Message low - red	The reporting test for the lower threshold value - red is defined with this parameter.
3	Message low - yell.	The reporting test for the lower threshold value - yellow is defined with this parameter.
4	Message ok - green	The reporting test for the 'green range' is defined with this parameter.
5	Message high - yell.	The reporting test for the upper threshold value - yellow is defined with this parameter.
6	Message high - red	The reporting test for the upper threshold value - red is defined with this parameter.

If parameter 2 ... 6 are called up, an input window is opened as shown in section Text input [▶ 19].

The following chart shows the connection between the thresholds and the colour change.

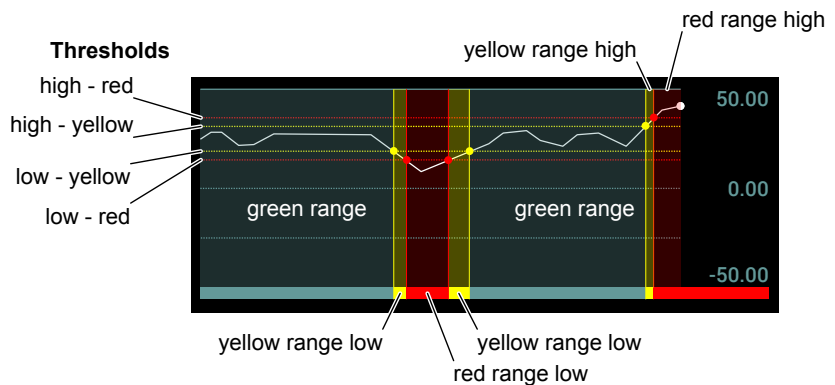

Fig. 62: Thresholds

Submenu: Input signal [Level 5]

Menu path: Main menu/Configuration/Inputs/Analogue input 1/Input signal

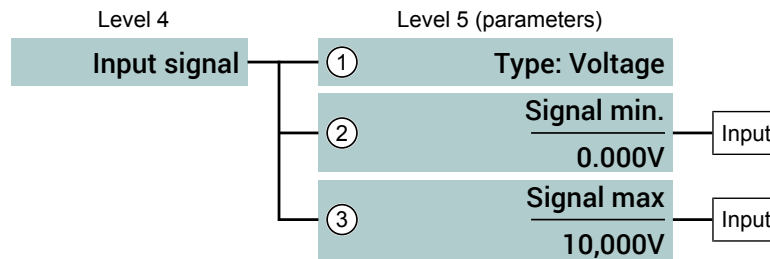

Fig. 63: Menu Input signal

Item	Value range	Description
1	Type: Voltage Type: Current	The signal type is defined with this parameter. Depending on the signal type, the units of the following parameters will change.
2	Signal min. 0.000V ... 10.500 V 0.000mA ... 20.500 mA	This parameter defines the lower signal limit of the input signal. This entry must lie within the permissible signal limits.
3	Signal max. 0.000V ... 10.500 V 0.000mA ... 20.500 mA	This parameter defines the upper signal limit of the input signal. This entry must lie within the permissible signal limits.

Submenu: Characteristic curve [Level 5]

The parameter function determines the characteristic curve type and can accept the following values:

Signpost [▶ Page]



Function = <linear> [▶ 44]
Function = <root extracted> [▶ 46]
Function = <Flow rate> [▶ 48]
Function = <Table> [▶ 50]
Function = <Difference> [▶ 53]
Function = <dyn. filter monitoring> [▶ 56]

NOTICE! Each characteristic curve type requires other parameters so that the menu changes depending on the parameter value.

(a) Function: linear [Level 5]

Menu path: Main menu/Configuration/Inputs/Analogue input 1/Characteristic curve/

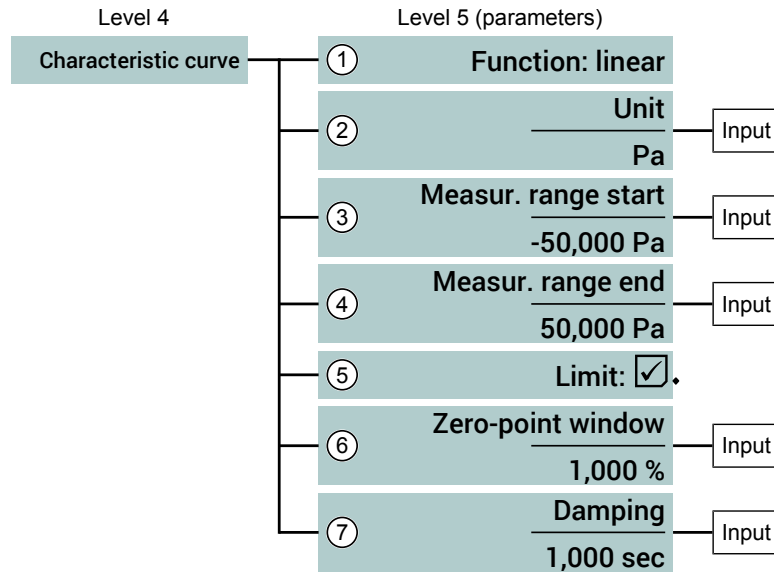

Fig. 64: Menu Characteristic curve linear

NOTICE! The output signal always follows the display value

Pos.	Value range	Description
1	Function: linear	The characteristic curve type ,linear' is selected.
2	Unit	A variable unit for the input signal is defined with this parameter.
3	Measuring range start	The start of the measuring range is defined with this parameter.
4	Measuring range end	The end of the measuring range is defined with this parameter.
5	Limits <input checked="" type="checkbox"/> Yes (standard value) <input checked="" type="checkbox"/> No	The display and analogue signal can be limited to the set measuring range (start - end) with this parameter.
6	Zero-point window 0.00 ... 25.00 %	This parameter is used to set a range around zero at which the measured value is set to zero (see fig.).
7	Damping 0.000 ... 30.000 s	The input signal can be dampened with this parameter.

Zero-point window

In many cases, unsteady readings are not a problem during normal operating mode, but this is not true for the idle state, i.e. if a display value of zero is expected.

You can use the parameter **Zero-point window** to define a range around zero (NPF). All measured values within the zero-point window are displayed as a zero value on the display. If the measured value leaves this range, the display value f(x) is initially approached. From a window value NPF_{exit}, the measured value and the reading match again.

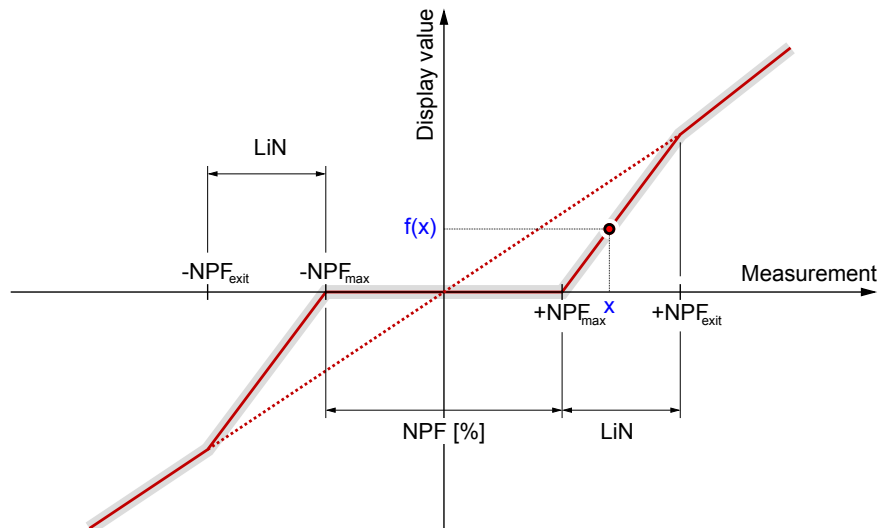

MB_A = Measuring range start
 MB_E = Measuring range end
 NPF = Zero-point window

LiN = Linear approximation range

Linear approximation:

$$NPF_{max} = |MB_E - MB_A| * \frac{NPF}{100} * 0,5$$

$$f(x) = \frac{|x| - NPF_{max}}{NPF_{exit} - NPF_{max}} * NPF_{exit}$$

$$NPF_{exit} = 2 * NPF_{max}$$

Fig. 65: Zero-point window

b) Function: root extracted [Level 5]

Menu path: Main menu/Configuration/Inputs/Analogue input 1/Characteristic curve/

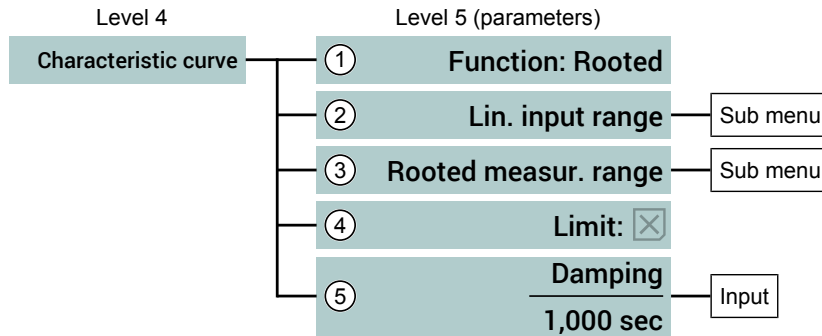

Fig. 66: Menu Characteristic curve root extracted

The input characteristic curve can be switched to a root extracted characteristic curve with the parameter value <Function: root extracted>. There are two additional submenus on the parameter level.

- In the Submenu: Lin. input range [Level 6] [▶ 46] the input range is configured according to the technical data of the sensor that is used.
- In the Submenu: Rooted measur. range [Level 6] [▶ 47] the measuring range (start, end, unit) is configured.

Pos.	Value range	Description
1	Function: Root extracted	The characteristic curve type ,root squared' is selected.
2	Lin. input range	Submenu for configuration of the linear input range.
3	Root extracted measuring range	Submenu for configuration of the root extracted measuring range.
4	Limits <input checked="" type="checkbox"/> Yes (standard value) <input checked="" type="checkbox"/> No	The display and output signal can be limited to the set measuring range (start - end) with this parameter.
5	Damping 0.000 ... 30.000 s	The input signal can be dampened with this parameter.

Submenu: Lin. input range [Level 6]

Menu path: Main menu/ Configuration/ Inputs/Analogue input 1/Characteristic curve: root squared/lin. measuring range/

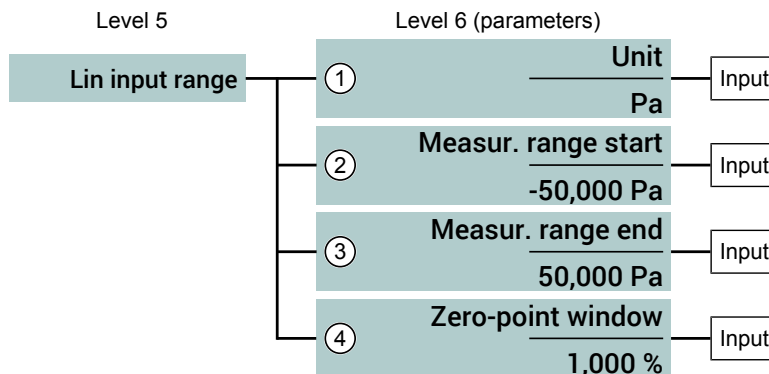

Fig. 67: Submenu: Lin. input range

Pos.	Value range	Description
1	Unit	A unit for the measuring value display is defined with this parameter. It must have a length of at least 5 characters.
2	Measuring range start	The start of the measuring range is defined with this parameter.
3	Measuring range end	The end of the measuring range is defined with this parameter.
4	Zero-point window 0.00 ... 25.00 %	This parameter is used to set a range around zero at which the measured value is set to zero. ^{*)}

^{*)} See section (a) Function: linear [Level 5] [▶ 44].

Submenu: Rooted measur. range [Level 6]

Menu path: Main menu/ Configuration/ Inputs/Analogue input 1/Characteristic curve: root squared/root extracted measuring range/

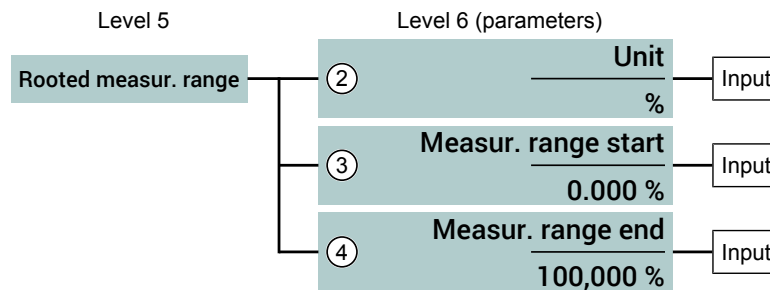

Fig. 68: Submenu: Root extracted measuring range

Pos.	Value range	Description
1	Unit	A unit for the measuring value display of the root extracted signal is defined with this parameter. It must have a length of at least 5 characters.
2	Measuring range start	The start of the measuring range is defined with this parameter.
3	Measuring range end	The end of the measuring range is defined with this parameter.

c) Function: Flow rate [Level 5]

Menu path: Main menu/Configuration/Inputs/Analogue input 1/Characteristic curve/

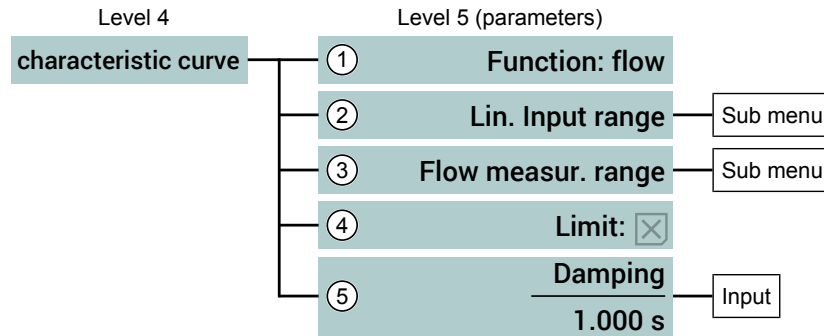

Fig. 69: Menu characteristic curve flow rate

The parameter value <Function: Flow> is used to switch the input characteristic curve to a square rooted characteristic curve that is adapted to the flow measurement. There are two additional submenus on the parameter level.

- In the submenu: Lin. input range [▶ 48] [Level 6] the input range is configured according to the technical data of the sensor used.
- In the submenu: Flow measuring range [▶ 49] [Level 6] the measuring range is automatically configured using system parameters.

Pos.	Value range	Description
1	Function: Flow rate	The characteristic curve type ,flow' is selected.
2	Lin. input range	Submenu for configuration of the linear input range.
3	Flow rate measuring range	Submenu for configuring the measuring range.
4	Limits <input checked="" type="checkbox"/> Yes (standard value) <input checked="" type="checkbox"/> No	The display and output signal can be limited to the set measuring range (start - end) with this parameter.
5	Damping 0.000 ... 30.000 s	The input signal can be dampened with this parameter.

Submenu: Lin. input range [Level 6]

Menu path: Main menu/ Configuration/ Inputs/Analogue input 1/Characteristic curve: flow/lin. measuring range/

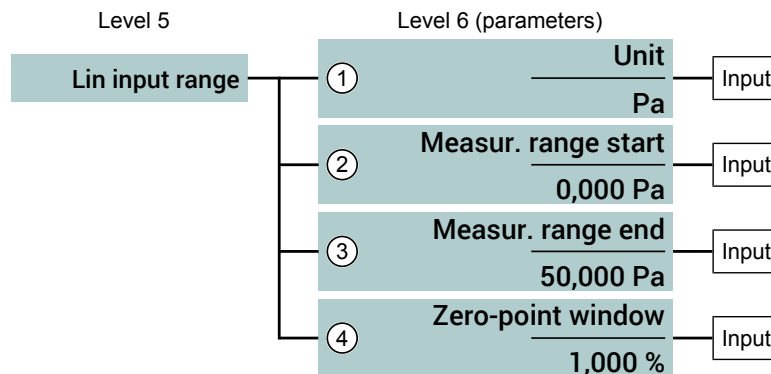

Fig. 70: Submenu: Lin. input range

Pos.	Value range	Description
1	Unit	Unit of the connected linear differential pressure transmitter
2	Measuring range start	The start of the measuring range is defined with this parameter.
3	Measuring range end	The end of the measuring range is defined with this parameter.
4	Zero-point window 0.00 ... 25.00 %	This parameter is used to set a range around zero at which the measured value is set to zero. ^{*)}

^{*)} See section a) Characteristic curve: linear [Level 5].

NOTICE! The measuring range start must always be set to zero in the flow measurement. Other values will lead to an error message.

Submenu: Flow rate measuring range [Level 6]

Menu path: Main menu/ Configuration/ Inputs/Analogue input 1/Characteristic curve: Flow/Flow measuring range/

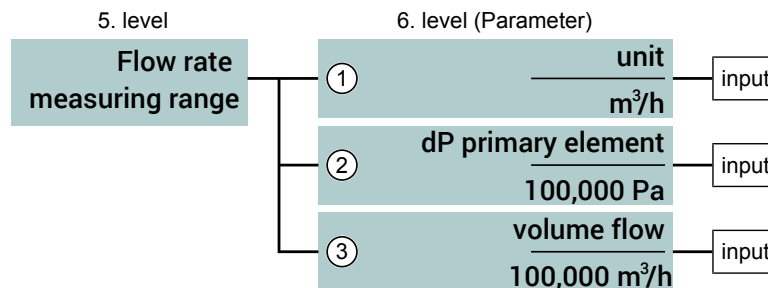

Fig. 71: Submenu: Flow rate measuring range

Pos.	Value range	Description
1	Unit m³/h	Flow measurement unit
2	Differential pressure sensor 0 ... 999999 Pa	System parameter: Differential pressure of the differential pressure sensor at the value defined by the parameter <Volume flow> .
3	Volume flow 0 ... 999999 m³/h	System parameter: Flow rate at the value defined by the parameter <dP Differential pressure> .

The square rooted function (measuring range start and end) is automatically calculated from the system parameters.

NOTICE! The value zero is not allowed for the parameter dP Differential pressure sensor and leads to an error message.

d) Function: Table [Level 5]

Menu path: Main menu/Configuration/Inputs/Analogue input 1/Characteristic curve/

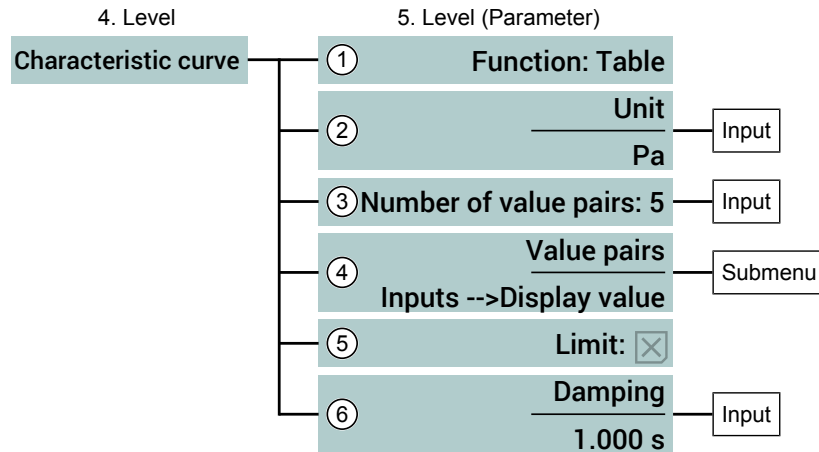

Fig. 72: Menu characteristic curve table

Pos.	Value range	Description
1	Function: Table	The characteristic curve type 'table' is selected.
2	Unit	A unit for the display value is defined with this parameter. It must have a length of at least 5 characters.
3	Number of value pairs	This parameter is used to define the number of value pairs of a table.
4	Value pairs	An input value is assigned to a display value for every value pair.
5	Limits <input checked="" type="checkbox"/> Yes (standard value) <input checked="" type="checkbox"/> No	The display and analogue signal can be limited to the set measuring range (start - end) with this parameter.
6	Damping 0.000 ... 30.000 s	The input signal can be dampened with this parameter.

The table function can be used to correct the input characteristic curve of the sensor at any point (support points). The changes impact on the display value and the output signal.

Each support point is stated by a value pair from the input value (Ex) and output value (Ax). The index 'x' states the number of the value pair. At least three value pairs always need to be stated. The maximum number (n) is 30.

The first value pair is assigned to the start of the measuring range and the last value pair to the end of the measuring range. There is a linear interpolation of the characteristic curve between two values. The following value always needs to be larger than its predecessor. A smaller value is not allowed. In the case of a decreasing characteristic curve, the successor always needs to be smaller than the predecessor.

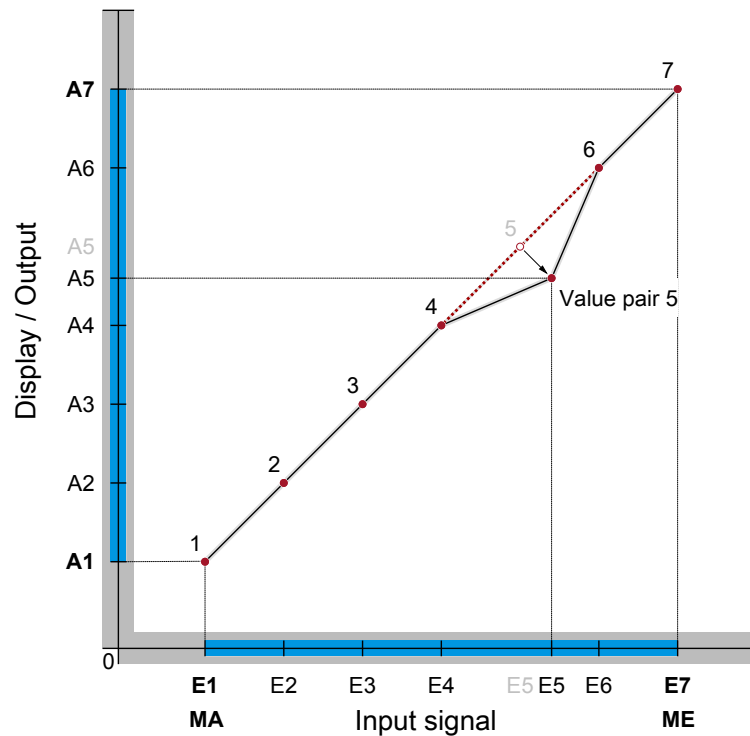

Fig. 73: Table function (n=7)

The table should comprise 7 value pairs. Of the input signal 0 ... 10 V, the range 2 ... 8V should be used. The basic measuring range is 0 ... 100 Pa. The display should display in the start of the measuring range 10 Pa and at the end of the measuring range 80 Pa.

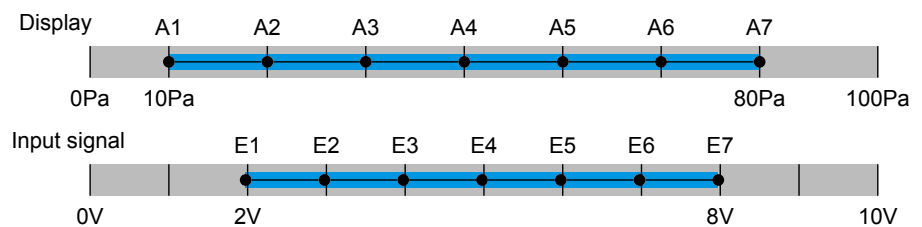

Fig. 74: Characteristic curve scale

Example:

Number of value pairs $n = 7$
 Input signal Start $E1 = 2\text{ V}$
 Input signal End $E7 = 8\text{ V}$
 Display range start $A1 = 10\text{ Pa}$
 Display range end $A7 = 80\text{ Pa}$

E1= 2V	A1= 10,000 Pa
E2= 3V	A2= 20,000 Pa
E3= 4V	A3= 30,000 Pa
E4= 5V	A4= 40,000 Pa
E5= 6..2V	A5= 40.750 Pa
E6= 7V	A6= 60,000 Pa
E7= 8V	A7= 80,000 Pa

← deviating value
(see graphic tabel function)

Fig. 75: Calculation of the characteristic curve

Submenu: Value pairs [Level 6]

Menu path: Main menu/ Configuration/ Inputs/Analogue input 1/Characteristic curve: Table/value pairs/

NOTICE! An empty table is available as standard. The user needs to calculate and enter the support points.

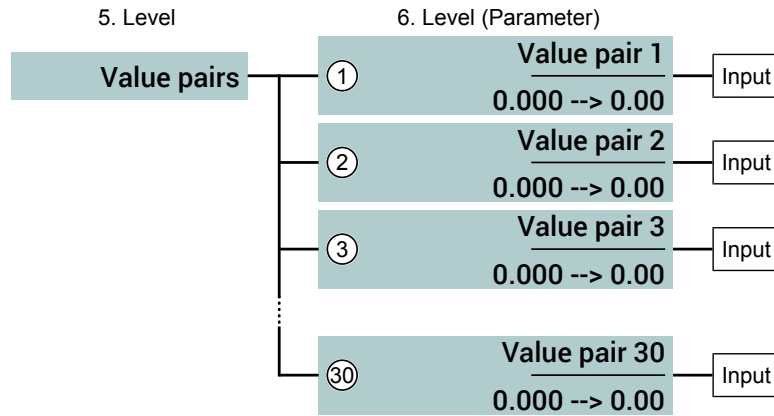
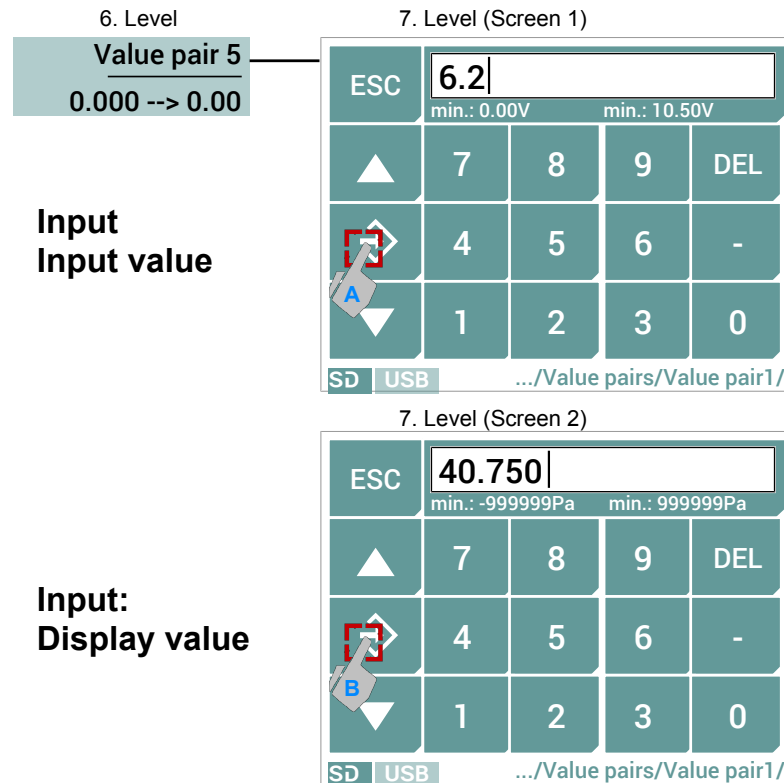

Fig. 76: Submenu: Value pairs

Value pairs input [Level7]

Menu path: Main menu/ Configuration/ Inputs/Analogue input 1/Characteristic curve: Table/Value pairs/Value pair1/



e) Function: Difference [Level 5]

Menu path: Main menu/Configuration/Inputs/Analogue input 1/Characteristic curve/

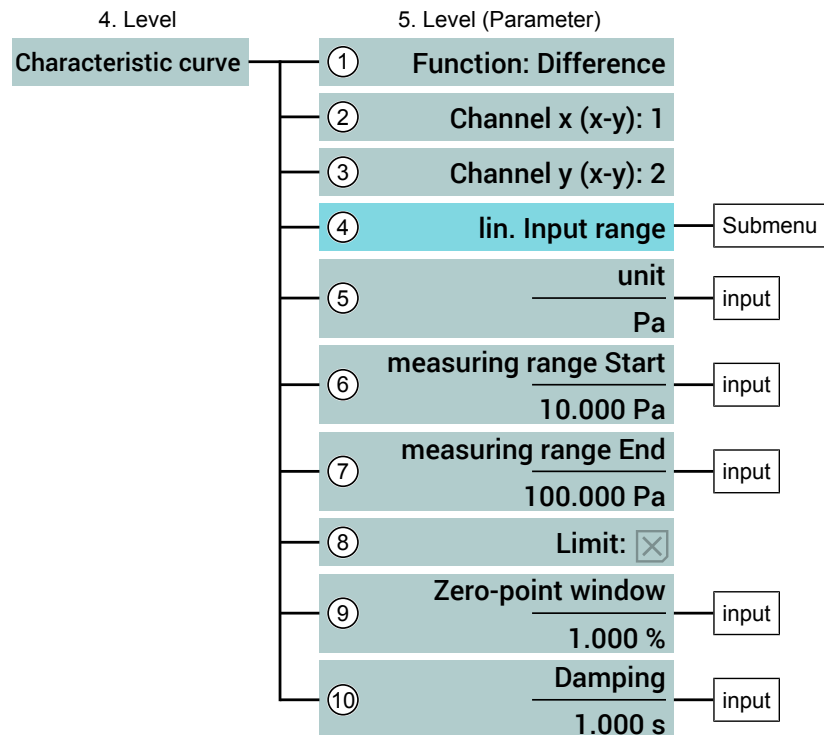

Fig. 77: Menu characteristic curve difference

Pos.	Value range	Description
1	Function: Difference	The function 'Difference' is selected. The characteristic curve is calculated from the mathematical difference of two channels
2	Channel x (x-y) 1 ... 4	This parameter is used to select the channel (ex) that acts as the minuend.
3	Channel y (x-y) 1 ... 4	This parameter is used to select the channel (Ey) that acts as the subtrahend.
4	Lin. input range	Submenu for configuring the linear starting range.
5	Unit	A unit for the display value is defined with this parameter. It must have a length of at least 5 characters.
6	Measuring range start	The start of the measuring range for the difference is defined with this parameter.
7	Measuring range end	The end of the measuring range for the difference is defined with this parameter.
8	Limits <input checked="" type="checkbox"/> Yes (standard value) <input checked="" type="checkbox"/> No	This parameter can be used to limit the display and output signal to the set difference measuring range (start - end).
9	Zero-point window 0.00 ... 25.00 %	This parameter is used to set a range around zero at which the measured value is set to zero. ^{*)}
10	Damping 0.000 ... 30.000 s	The input signal can be dampened with this parameter.

^{*)} See section a) Function: linear [Level 5]. [▶ 44]

NOTICE! As stated at the outset, the parameters are explained using the example of the analogue input 1. The menu for the characteristic curve therefore refers to the analogue input 1.

This function can be used to calculate the difference between two **random** input channels and assigned this to the analogue input 1. If the difference between channel 1 and another channel is created, this difference refers to channel 1 itself. However, it would then no longer be possible to configure the original input signal from channel 1. The submenu **lin. Entrance area** is shown in a case like this for this reason. In all other cases the menu is not shown.

- n Number of the analogue input that needs to be configured
- x, y Numbers of the analogue input whose difference needs to be calculate
- Value range = {1,2,3,4}
- with $x \neq y$
- $E_n = E_x - E_y$

The difference is always assigned to the input channel from which it was called up. The pure number values (Mantisse) are used for the calculation.

- Steps must be taken to check whether the same unit is used for all input signals.
- Different functions (linear, square rooted, table, etc.) can be used for the input channels. The user must check the relevance of a difference of this kind.

3. Level (Submenu)

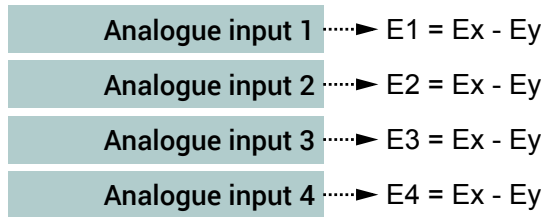

Example:

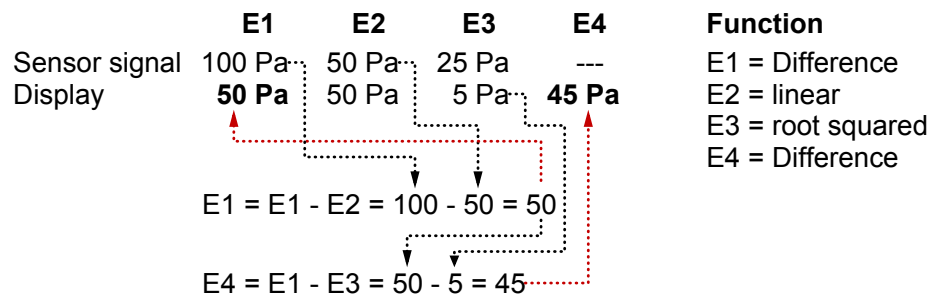

In this example, the input channel E4 acts as a 'virtual channel' because no sensor is connected.

Submenu: Lin. input range [Level 6]

Menu path: Main menu/ Configuration/ Inputs/Analogue input 1/Characteristic curve: Difference/lin. measuring range/

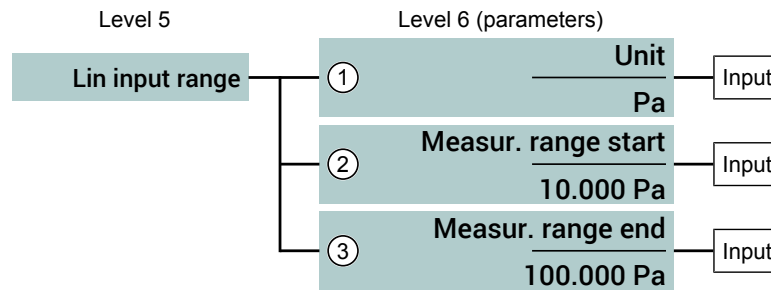

Fig. 78: Submenu: Lin. input range

Pos.	Value range	Description
1	Unit	A unit for the measuring value display is defined with this parameter. It must have a length of at least 5 characters.
2	Measuring range start	The start of the measuring range is defined with this parameter.
3	Measuring range end	The end of the measuring range is defined with this parameter.

f) Function: dyn. filter monitoring [Level 5]>

Menu path: Main menu/Configuration/Inputs/Analogue input 1/Characteristic curve/

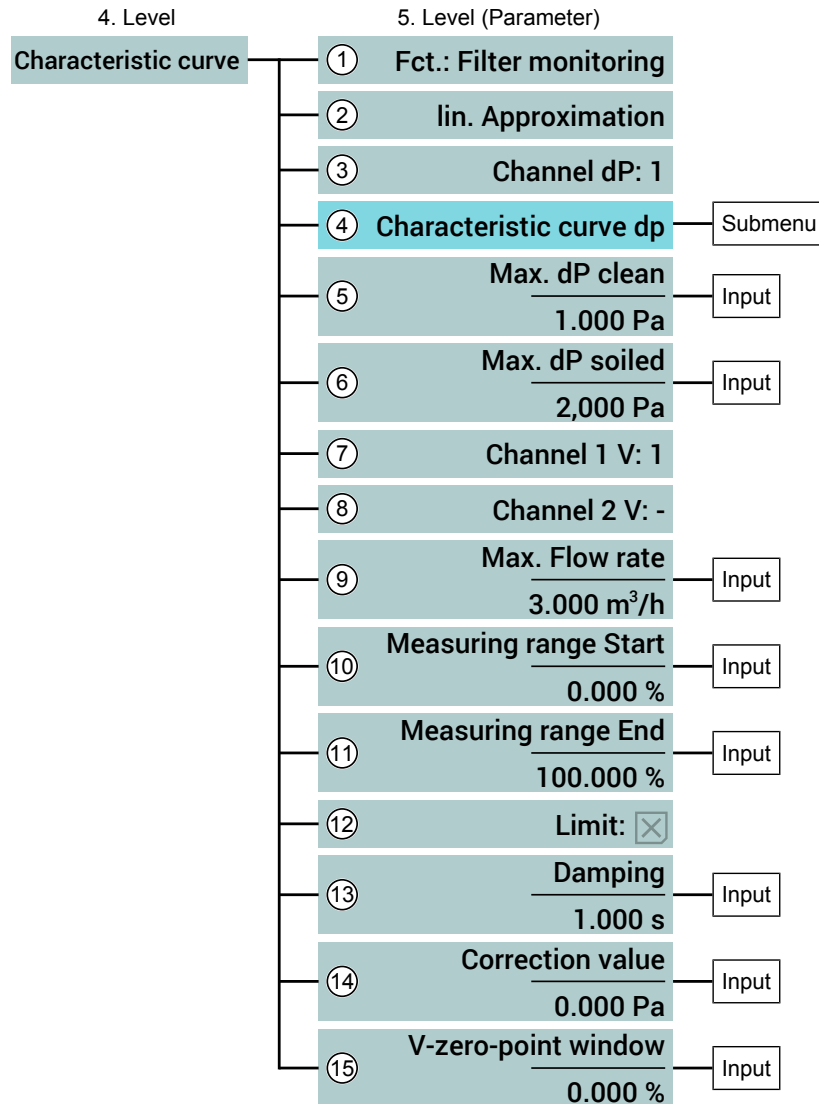

Fig. 79: Menu characteristic curve dyn. filter monitoring

Pos.	Value range	Description
1	Fct.: Filter monitoring	The dyn. filter monitoring function is selected.
2	Lin. approximation Rad. approximation	This switch selects which approximation switch is used. Usually, the linear approximation is selected.
3	Channel dP:1 1 ... 4	This switch is used to select the channel for monitoring differential pressure.
4	Characteristic curve dP	Submenu for configuring the linear starting range.
5	Max. dP clean	This parameter defines the limit value for the clean filter.
6	Max. dP soiled	This parameter defines the limit value for the soiled filter.

Pos.	Value range	Description
7	Channel 1 V:1 1 ... 4	This parameter determines the channel for the volume flow measurement.
8	Channel 2 V:- -,1 ... 4	This parameter can determine a second channel for the volume flow measurement. The sum of channel 1 V + channel 2 V is the total flow through the filter. Channel 2 V is switched off with the value '-'. .
9	Max. volume flow	This parameter defines the upper limit for the flow rate.
10	Measuring range start	The start of the measuring range is defined with this parameter.
11	Measuring range end	The end of the measuring range is defined with this parameter.
12	Limit <input checked="" type="checkbox"/> Yes <input checked="" type="checkbox"/> No	This parameter can be used to limit the display and output signal to the set difference measuring range (start - end).
13	Damping 0.000 s ... 30,000 s	The input signal can be dampened with this parameter.
14	Correction value	This parameter can be used to set an offset for the characteristic curve.
15	V-zero-point window 0 % ... 50 %	The size of the zero-point window is defined with this parameter.

Submenu: Characteristic curve dP [Level 6]

Menu path: Main menu/ Configuration/ Inputs/Analogue input 1/Characteristic curve: Dyn. filter monitoring/Characteristic curve dP/

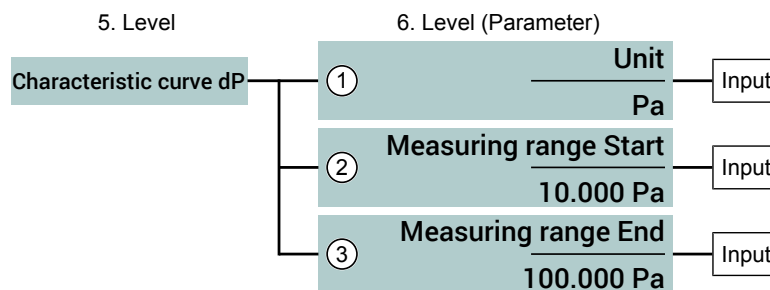

Fig. 80: Submenu: Characteristic curve dP

Pos.	Value range	Description
1	Unit	A unit for the measuring value display is defined with this parameter. It must have a length of at least 5 characters.
2	Measuring range start	The start of the measuring range is defined with this parameter.
3	Measuring range end	The end of the measuring range is defined with this parameter.

Explanations about dynamic filter monitoring

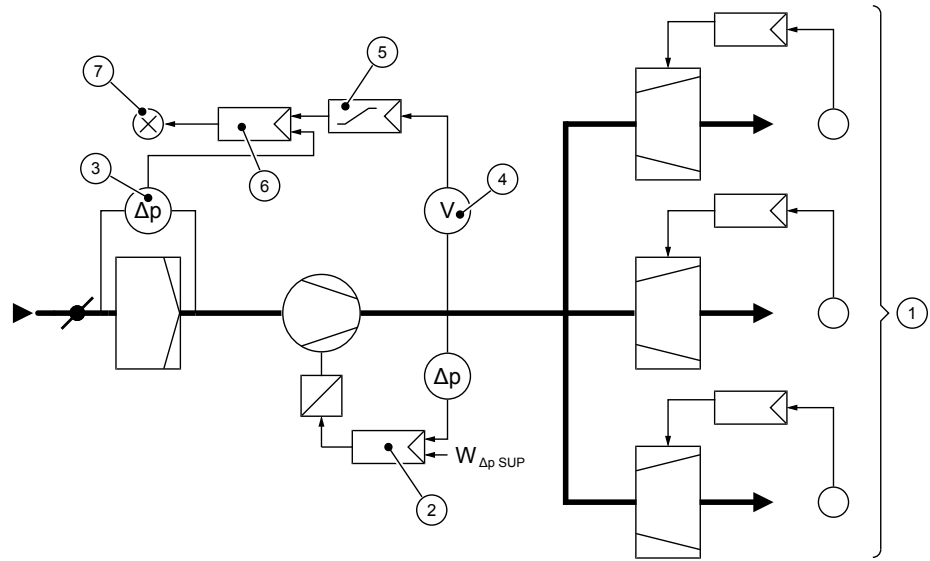

Fig. 81: Filter monitoring principle sketch

1	Zones with variable supply air volume flow
2	Supply air pressure control with ventilator speed control
3	Differential pressure sensor of the filter monitoring (channel dP)
4	Flow rate sensor (Channel 1 V)
5	Target value guide encoder
6	Difference pressure controller of the filter monitoring
7	Air filter - fault message

The air filter in this example has the task of retaining dust-like soiling from the outside air. As the soiling increases, the differential pressure measured above the filter increases. As soon as the differential pressure exceeds the set limit, the filter sensor reports that the filter is soiled. This is shown as a malfunction.

The flow rate control keeps the air flow rate constant despite an increase in soiling by raising the ventilator speed. The pressure drop above the air filter does not, however, just depend on the level of soiling, but also the size of the flow rate.

The pressure drop will change in the flow rate squared. Therefore, a reduction of the flow rate from 100 % to 50 % means a reduction of the pressure loss above the filter element from 100 % to 25 %.

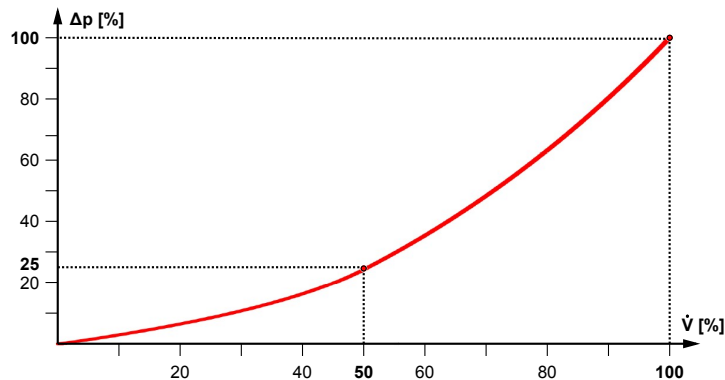

Fig. 82: Dependency on the volume flow

To be able to determine the level of soiling in a differential pressure measurement, it is therefore necessary to carry out the measurement at the maximum flow rate. This is measured at regular intervals.

This is not necessary for dynamic filter monitoring. An approximation of the filter characteristic curve is calculated by determining some system-specific parameters. This approximating characteristic curve can now be used to determine the level of soiling of the filter at any time without changing the ventilator speed.

Parameters

The differential pressure in the filter increases as dust is deposited. This increase for large dust filters is approximated in a squared manner and in a linear manner for suspended matter filters. The approximation equation that is used therefore depends on the system.

There are four channels available to measure differential pressure and flow rate. Therefore, two air filters can be monitored with one device.

If two ventilation channels are set to one filter, a further input is required to monitor the second flow rate. In this case, only one filter can be monitored.

Example1:

One air filter should be monitored on which two ventilation channels are placed. The level of soiling, the differential pressure and the two flow rates should be shown.

Parameters	Channel	Display
Analogue input1	Channel 1	Degree of soiling
Channel dP: 2	Channel 2	Differential pressure
Channel 1V: 3	Channel 3	Volume flow 1
Channel 2V: 4	Channel 4	Volume flow 2

Example2:

Two air filters can be monitored with one device. The level of soiling and flow rate should be shown.

Parameters	Channel	Display
Analogue input1	Channel 1	Degree of soiling filter 1
Channel dP: 1	Channel 1	
Channel 1V: 2	Channel 2	Volume flow filter 1
Analogue input3	Channel 3	Degree of soiling filter 2
Channel dP: 3	Channel 3	
Channel 1V: 4	Channel 4	Volume flow filter 2

The filter characteristic curve generally looks like this:

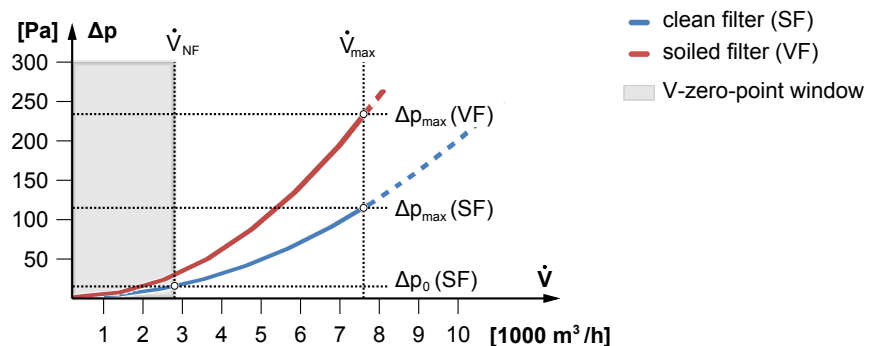

Fig. 83: Filter characteristic curve

Explanation of the variables used:

Flow rate $\dot{V} = \frac{dV}{dt}$ The flow rate states how much volume of a gas flows through. The flow rate is stated in m³/h.

\dot{V}_{max} Maximum flow rate of the ventilator.

\dot{V}_{NF} V-zero-point window
This parameter is used to define a range within which the differential pressure measuring values are reset to zero.

Differential pressure Δp Current differential pressure above the filter.

Δp_0 (SF) Differential pressure above the clean filter in the 'zero-point'. The 'zero-point' is determined by the V-zero-point window.

Δp_{max} (SF) differential pressure above the clean filter at a maximum

Δp_{max} (VF) differential pressure above the soiled filter at the maximum

The characteristic curves is approximated as follows.

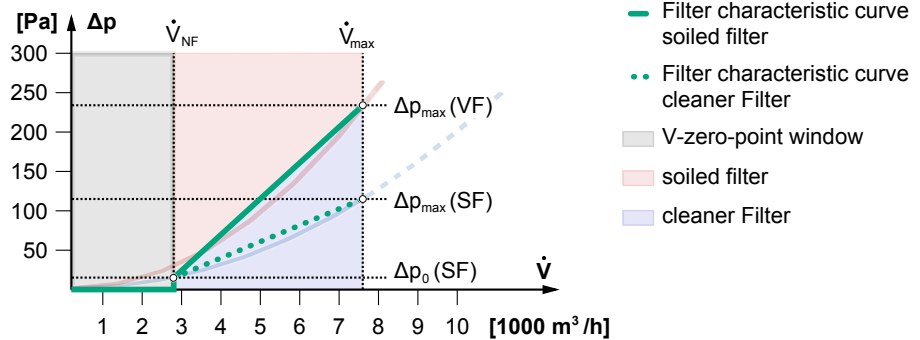

Fig. 84: Approximated filter characteristic curve

The parameter **Correction value** can set an offset (k) for the characteristic curve.

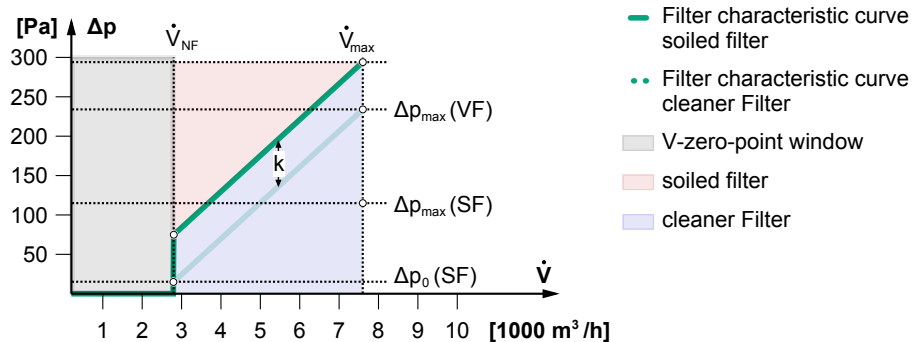

Fig. 85: Filter characteristic curve correction value

Submenu: Offset correction [Level 5]

Menu path: Main menu/Configuration/Inputs/Analogue input 1/Offset correction

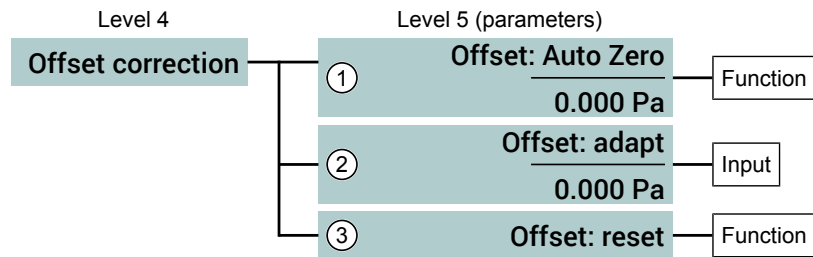

Fig. 86: Menu Offset correction

Item	Value range	Description
1	Offset: Auto Zero	The Auto Zero function is used to set the current measured value to the display value zero.
2	Offset: adapt	The offset can be adjusted manually within the given limits with this parameter.
3	Offset: reset	This parameter is used to set the offset to zero.

Submenu: Pres. of measurem. [Level 5]

Menu path: Main menu/Configuration/Inputs/Analogue input 1/Pres. of measurem./

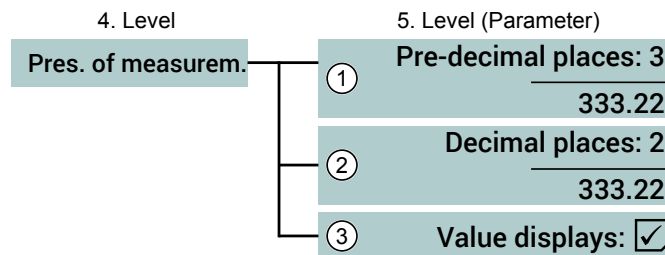

Fig. 87: Menu Pres. of measurem.

There are max 6 positions available for showing the measured value.

Pos.	Value range	Description
1	Integer digits	The number of places in front of the decimal point with this parameter.
2	Decimal Places	The number of places after the decimal point is set with this parameter.
3	Display value <input checked="" type="checkbox"/> Yes <input checked="" type="checkbox"/> No	This parameter can be used to switch off the measured value display. The 'state' of the analogue input is only signalled by the colour change.

Submenu: Colour change [Level 5]

Menu path: Main menu/Configuration/Inputs/Analogue input 1/Colour change/

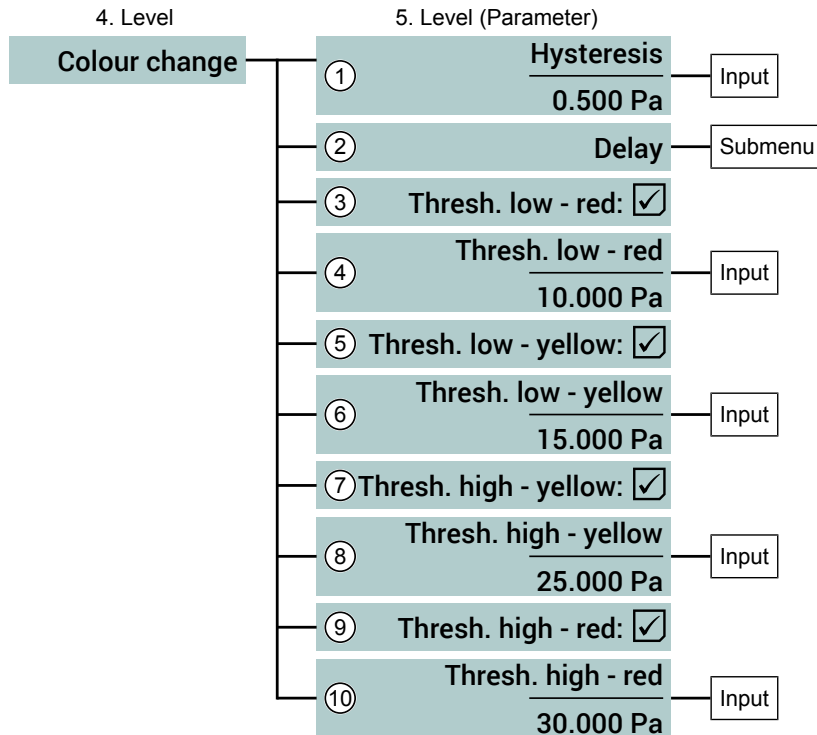

Fig. 88: Menu Colour-change

NOTICE! Value range

The displayed value range of some parameters depends on the set measuring range. The following value ranges serve as examples.

Pos.	Value range	Description
1	Hysteresis 0.00 ... 100.00 Pa	The hysteresis of the colour change is defined with this parameter.
2	Deceleration	Submenu for configuration of the time delay of the colour change
3	Threshold low - red <input checked="" type="checkbox"/> Yes <input checked="" type="checkbox"/> No	The name threshold is activated with this parameter.
4	Threshold low - red -100.00 ... 100.00 Pa	Input of the threshold
5	Threshold low - yellow <input checked="" type="checkbox"/> Yes <input checked="" type="checkbox"/> No	The name threshold is activated with this parameter.
6	Threshold low - yellow -100.00 ... 100.00 Pa	Input of the threshold
7	Threshold high - yellow <input checked="" type="checkbox"/> Yes <input checked="" type="checkbox"/> No	The name threshold is activated with this parameter.
8	Threshold high - yellow -100.00 ... 100.00 Pa	Input of the threshold

Pos.	Value range	Description
9	Threshold high red <input checked="" type="checkbox"/> Yes <input checked="" type="checkbox"/> No	The name threshold is activated with this parameter.
10	Threshold high red -100.00 ... 100.00 Pa	Input of the threshold

Colour change limit thresholds

Colour changes that correspond to certain operating statuses can be defined with the thresholds.

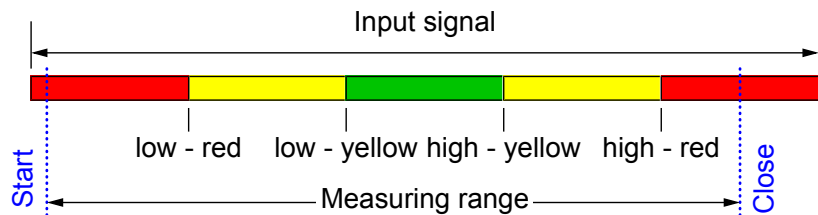

Fig. 89: Thresholds

Hysteresis

The parameter value defines the distance to the threshold. The following picture is created with a parameter value of 0.5:

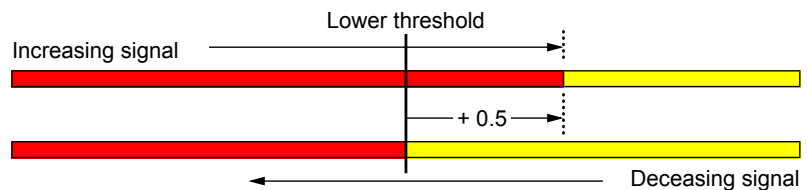

Fig. 90: Hysteresis

Submenu: Delay time [Level 6]

This parameter is used to set the delay time for the colour changes. As soon as the measured value exceeds the limit threshold ⁽³⁾ a timer starts with the programmed delay time. The colour change takes place as soon as the timer has expired and the overstepping of the threshold during this time remained.

If the measured value drops below the threshold whilst the timer is still running, it is reset and the colour change does not take place.

Two effect types of the delay of colour changes can be set:

- Delay: simple
- Delay: expanded

The menu depends on the selected effect type.

⁽³⁾ incl. hysteresis,

A. delay: simple

Menu path: Main menu/ Configuration/ Inputs/Analogue input 1/Colour change/ Delay time/

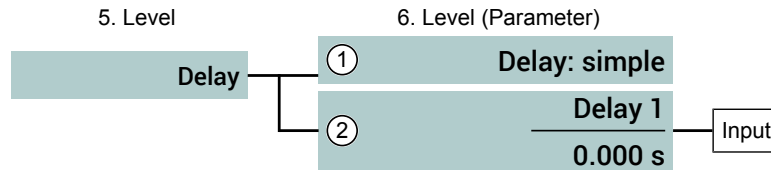

Fig. 91: Submenu: Delay: simple

Pos.	Value range	Description
1	Delay: simple	Changeover button effect type
2	Delay 1 0.00 ... 3600.000s	This parameter is used to set the delay time for all colour changes.

B. Delay: expanded

Menu path: Main menu/ Configuration/ Inputs/Analogue input 1/Colour change/ Delay time/

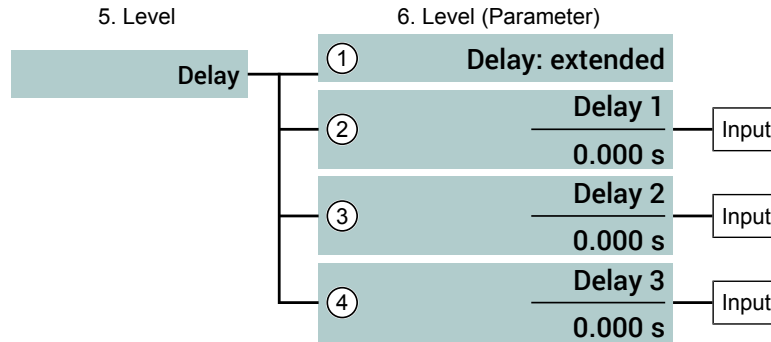

Fig. 92: Submenu: Delay: expanded

Pos.	Value range	Description
1	Delay: simple	Changeover button effect type
2	Delay 1 0.00 ... 3600.000s	This parameter is used to set the response time for the colour change from green to yellow.
3	Delay 2 0.00 ... 3600.000s	This parameter is used to set the response time for the colour change from yellow to red.
4	Delay 3 0.00 ... 3600.000s	This parameter is used to set the drop time for all colour changes.

Submenu: Acoustic alarm [Level 5]

Menu path: Main menu/Configuration/Inputs/Analogue input 1/Acoustic alarm/

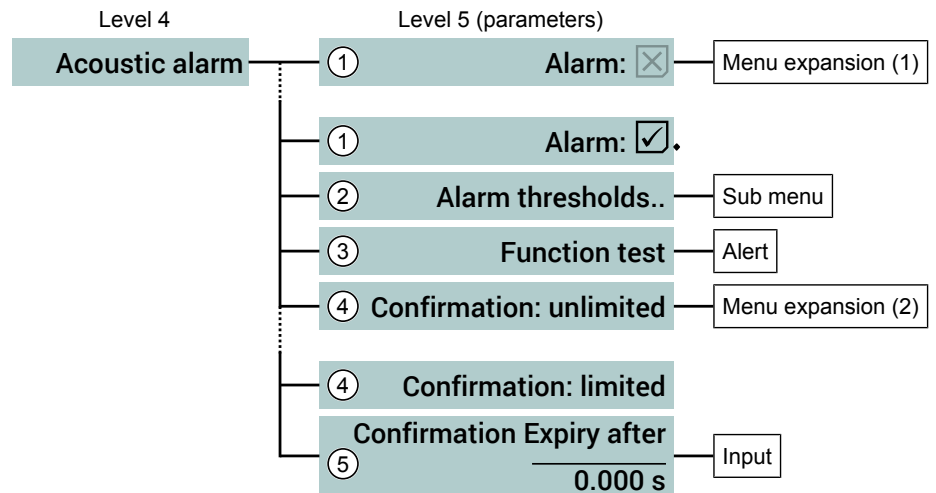

Fig. 93: Menu Acoustic alarm

Item	Value range	Description
1	Alarm <input checked="" type="checkbox"/> Yes <input checked="" type="checkbox"/> No (standard value)	At this point, the acoustic alarm can be switched on an off. The menu expands when the alarm is switched on.
2	Alarm thresholds	Submenu for configuration of the alarm thresholds.
3	Function test	This button is used to check the function of the alarm encoder.
4	Confirmation: Unlimited (standard value) limited	This parameter is used to determine how the unit behaves when the acoustic alarm is acknowledged. Unlimited: The acoustic alarm is set to rest when it is acknowledged. The alarm message is still shown. Limited: The acoustic alarm is only at rest for a certain time after it has been acknowledged. The alarm message is still shown.
5	Confirmation Expiry after 0.000 sec	This parameter sets the time after which the acoustic alarm sounds again.

Submenu: Alarm thresholds [Level 6]

Menu path: Main menu/Configuration/Inputs/Analogue input 1/Acoustic alarm/Alarm thresholds

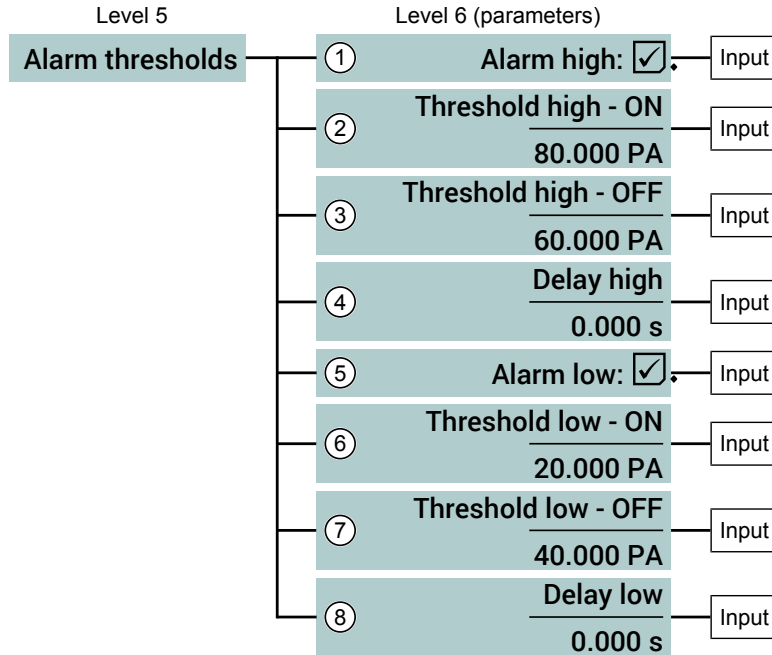

Fig. 94: Submenu: Alarm thresholds

Item	Value range	Description
1	Alarm high <input checked="" type="checkbox"/> On (standard value) <input type="checkbox"/> Off	The upper alarm threshold can be switched on or off with this parameter.
2	Threshold high - ON -50.0 ... 150.0 Pa	The activation point of the upper alarm threshold is defined with this parameter.
3	Threshold high - OFF -50.0 ... 150.0 Pa	The deactivation point of the upper alarm threshold is defined with this parameter.
4	Delay high 0 ... 3600 s	Alarm signal delay for the upper alarm threshold.
5	Alarm low <input checked="" type="checkbox"/> On (standard value) <input type="checkbox"/> Off	The lower alarm threshold can be switched on or off with this parameter.
6	Threshold low - ON -50.0 ... 150.0 Pa	The activation point of the lower alarm threshold is defined with this parameter.
7	Threshold low - OFF -50.0 ... 150.0 Pa	The deactivation point of the lower alarm threshold is defined with this parameter.
8	Delay high 0 ... 3600 s	Alarm signal delay for the upper alarm threshold.

Key:

- Input signal
- Measuring range
- Increasing input signal
- ← Decreasing input signal
- No alarm
- Alert

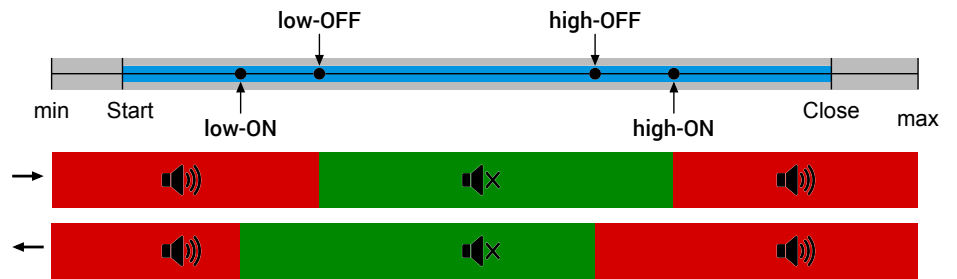

Fig. 95: Alarm thresholds

Input: Sensor serial number [Level 5]

Menu path: Main menu/ Configuration/ Inputs/Analogue input 1/Sensor serial number/

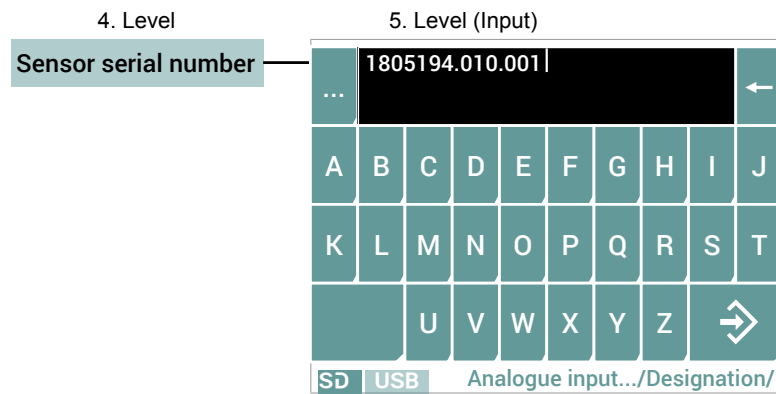

Fig. 96: Input sensor serial number

This parameter is used to file the serial number of the connected sensor. This allows identification of the installed sensor. However, other device codes can be used if they do not exceed 19 characters.

5.4.4.4 Menu: Outputs [Level 3]

Menu path: Main menu/Configuration/Outputs/

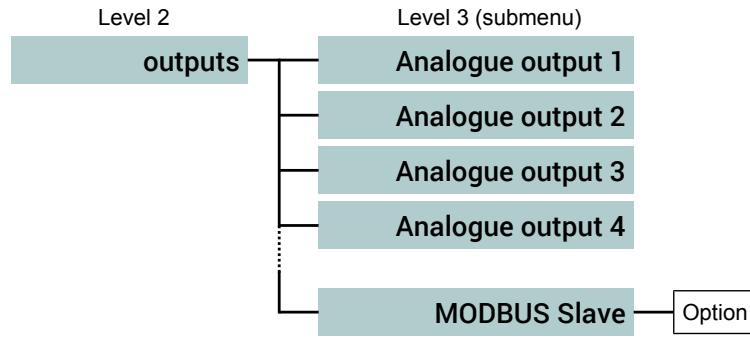

Fig. 97: Menu Outputs

All analogue outputs are configured in the same way. Therefore the associated parameters are explained below using the example of Analogue output 1.

In units that have a Modbus interface, a further menu appears at the end of the list to configure the Modbus RTU interface.

Menu: Analogue outp. 1 [Level 4]

Menu path: Main menu/Configuration/Outputs/Analogue output 1/

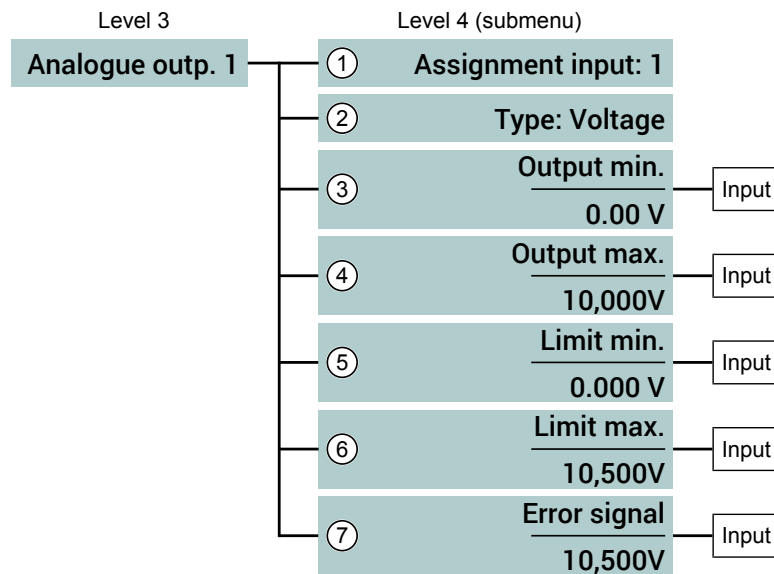

Fig. 98: Menu Analogue output 1

Item	Value range	Description
1	Assignment input: 1 Assignment input: 2 Assignment input: 3 Assignment input: 4 Assignment input: -	The respective input signal is assigned to the analogue output 1 with this parameter.
2	Type: Voltage Type: Current	This parameter is used to define whether the output signal is of the type current or voltage. The value range of the following parameters change depending on how this is defined.
3	Output min. 0.000 ... 10.500V 0.000 ... 21.500mA	This parameter is used to define the output signal that is issued in the measuring range start of the assigned input signal.

Item	Value range	Description
4	Output max. 0.000 ... 10.500V 0.000 ... 21.500mA	This parameter is used to define the output signal that is issued in the measuring range end of the assigned input signal.
5	Limit min. 0.000 ... 10.500V 0.000 ... 21.500mA	This parameter defines the lower limit of the output signal.
6	Limit max. 0.000 ... 10.500V 0.000 ... 21.500mA	This parameter defines the upper limit of the output signal.
7	Error signal 0.000 ... 10.500V 0.000 ... 21.500mA	The error signal type is defined with this signal.

Assignment input

It is always possible to assigned all output signals A1...A4 to a single input signal (e.g. E1).

Output signal

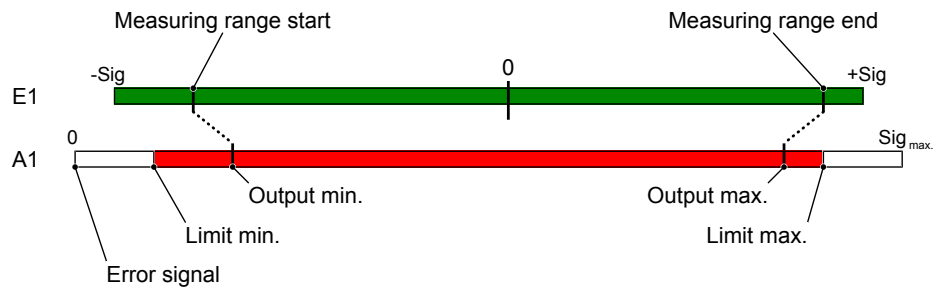

Fig. 99: Signal limits

Menü: MODBUS Slave

Menu path: Main menu/Configuration/Outputs/MODBUS Slave/

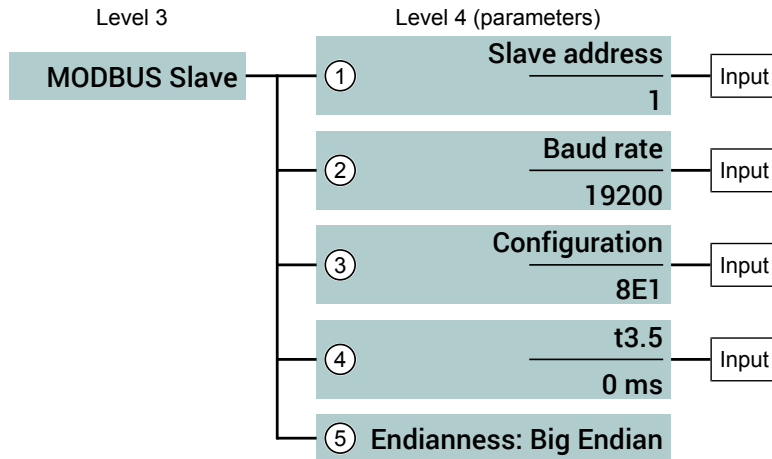

Fig. 100: Menü MODBUS Slave

Item	Value range	Description
1	Slave address 1 ... 255	The slave address is set with this parameter.
2	Baud rate 1200 ... 57600	The transfer rate is set with this parameter.
3	Configuration 8E1 ... 8O2	The bit sequence is defined with this parameter.
4	t3.5 0 ... 10000 ms	The time interval (RTU framing) can be extended with this parameter.
5	Endianness Big-Endian Little-Endian	The byte sequence is defined with this parameter.

Configuration

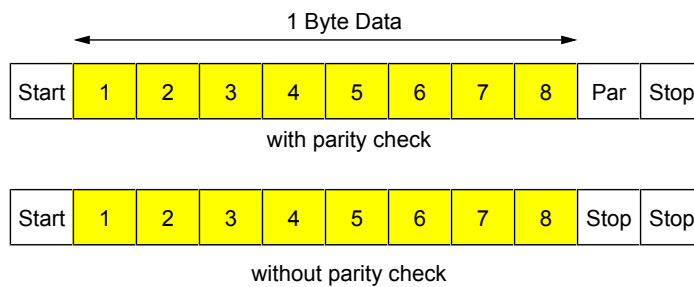

Fig. 101: MODBUS Bit Sequence

Bit sequences with a parity check and two stop bits are approved.

RTU Framing (t3.5)

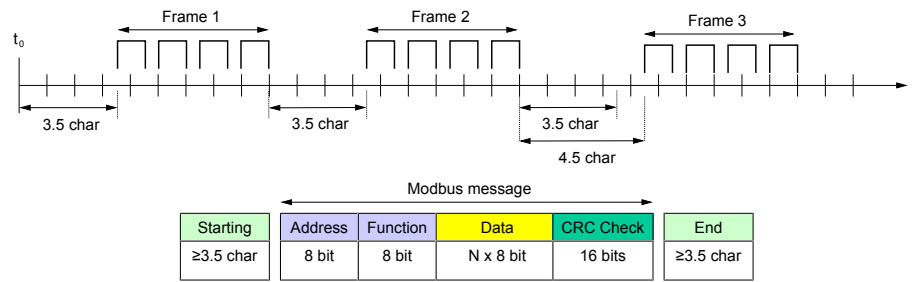

Fig. 102: Modbus Message Frame

In slow networks it may be necessary to prolong the time interval t3.5. Entries stated in ms.

$$t_{3.5} = \frac{\text{Number of bits}}{\text{Baud rate}} \times 3500 \text{ [ms]}$$

Fig. 103: Conversion t3.5 in ms

Usually, a bit sequence comprises 11 bits. Due to the fact that two stop bits are also approved for the parity check, the number of bits may sometimes be 12.

The calculated value t3.5 in ms is the lower limit that may not be undercut. Only inputs larger than this value will prolong the time interval.

5.4.4.5 Menu: Datalogger [Level 3]

Menu path: Main menu/Configuration/Datalogger/

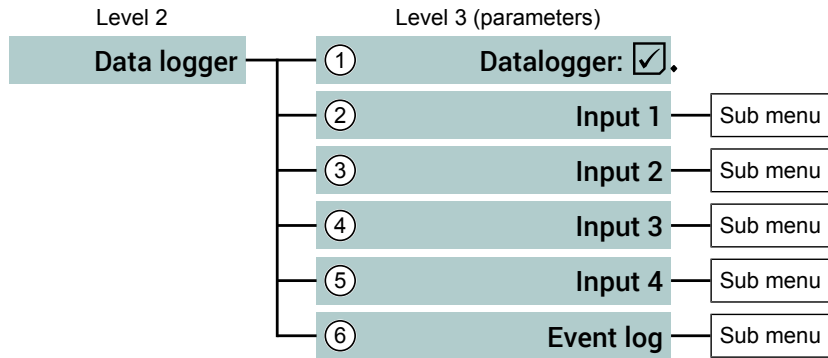
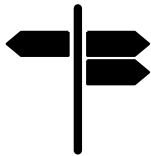

Fig. 104: Menu Datalogger

Signpost [▶ Page]

Menu: Input 1 [Level 4] [▶ 72]

Menu: Event log [Level 4] [▶ 73]



Item	Value range	Description
1	Data logger <input checked="" type="checkbox"/> Yes <input checked="" type="checkbox"/> No	The datalogger function can be switched on or off with this parameter.
2	Input 1	Sub menu
3	Input 2	Sub menu
4	Input 3	Sub menu
5	Input 4	Sub menu
6	Event log	Sub menu This menu can be used to define which events are logged and which are not logged.

The datalogger is configured in the same way for all inputs. Therefore the associated parameters are explained below using the example of input 1.

Menu: Input 1 [Level 4]

Menu path: Main menu/Configuration/Datalogger/Input 1/

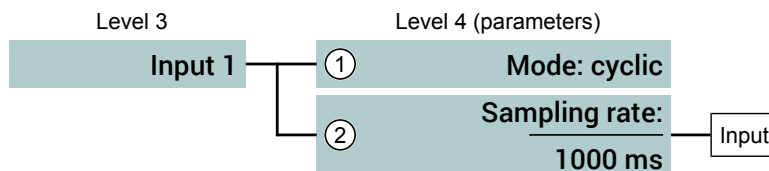

Fig. 105: Menu input 1

Item	Value range	Description
1	Mode: cyclic <input checked="" type="checkbox"/> OFF	The datalogger function for input 1 can be switched on or off with this parameter.
2	Sampling rate 125 ms, 250 ms, 500 ms, 1 ... 30 s, 1 ... 30 min	This parameter is used to determine the intervals in which the data is saved.

Menu: Event log [Level 4]

Menu path: Main menu/Configuration/Datalogger/Event log/

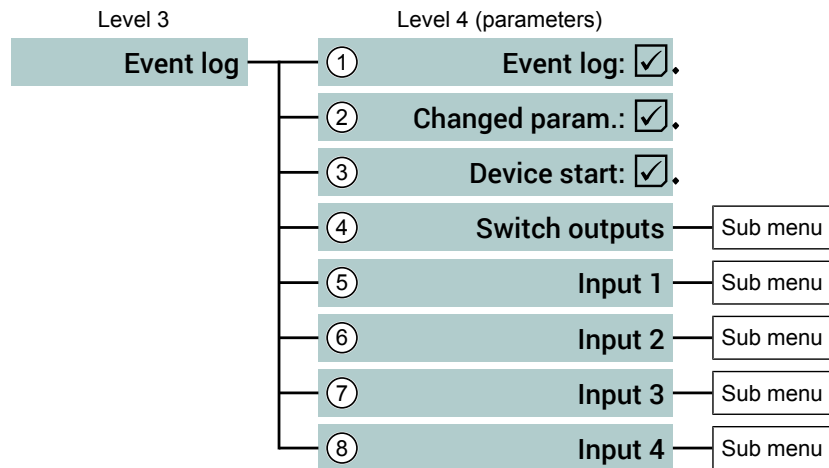
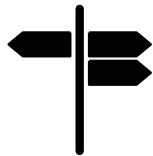

Fig. 106: Menu Event log

Signpost [▶ Page]

Submenu: Switch outputs [Level 5] [▶ 74]

Submenu: Input 1 [Level 5] [▶ 74]



Item	Value range	Description
1	Event log: <input checked="" type="checkbox"/> ON <input checked="" type="checkbox"/> OFF	The event log can be switched on or off with this parameter.
2	Changed param.: <input checked="" type="checkbox"/> ON <input checked="" type="checkbox"/> OFF	This parameter determines whether or not the changes to the parameter should be logged.
3	Device start: <input checked="" type="checkbox"/> ON <input checked="" type="checkbox"/> OFF	This parameter determines whether or not the device start should be logged.
4	Switch outputs	Sub menu
5	Input 1	Sub menu
6	Input 2	Sub menu
7	Input 3	Sub menu
8	Input 4	Sub menu

The event logger is configured in the same way for all inputs. Therefore the associated parameters are explained below using the example of input 1.

Submenu: Switch outputs [Level 5]

Menu path: Main menu/Configuration/Datalogger/Switch outputs/

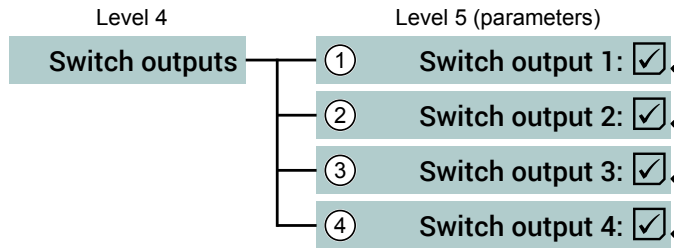

Fig. 107: Menu Switch outputs

Item	Value range	Description
1	Switch output 1: <input checked="" type="checkbox"/> ON <input checked="" type="checkbox"/> OFF	This parameter determines whether or not the switch output 1 should be logged.
2	Switch output 2: <input checked="" type="checkbox"/> ON <input checked="" type="checkbox"/> OFF	This parameter determines whether or not the switch output 2 should be logged.
3	Switch output 3: <input checked="" type="checkbox"/> ON <input checked="" type="checkbox"/> OFF	This parameter determines whether or not the switch output 3 should be logged.
4	Switch output 4: <input checked="" type="checkbox"/> ON <input checked="" type="checkbox"/> OFF	This parameter determines whether or not the switch output 4 should be logged.

Submenu: Input 1 [Level 5]

Menu path: Main menu/Configuration/Datalogger/Input 1/

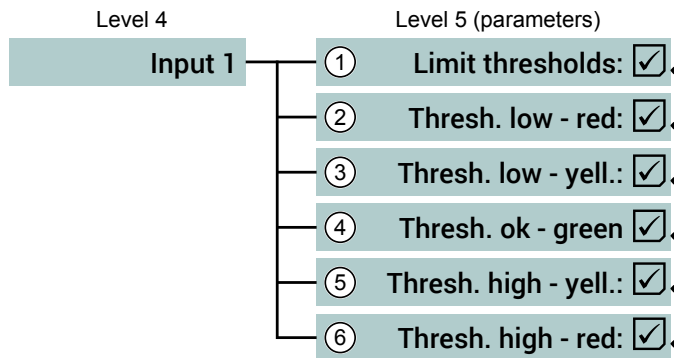

Fig. 108: Menu input 1

Item	Value range	Description
1	Limit thresholds <input checked="" type="checkbox"/> ON <input checked="" type="checkbox"/> OFF	This parameter determines whether or not the thresholds should be logged.
2	Thresh. low - red <input checked="" type="checkbox"/> ON <input checked="" type="checkbox"/> OFF	This parameter can be used to activate or deactivate the logging of the respectively stated thresholds.
3	Thresh. low – yell.	

Item	Value range	Description
	<input checked="" type="checkbox"/> ON <input checked="" type="checkbox"/> OFF	
4	Thresh. ok - green <input checked="" type="checkbox"/> ON <input checked="" type="checkbox"/> OFF	
5	Thresh. high – yell. <input checked="" type="checkbox"/> ON <input checked="" type="checkbox"/> OFF	
6	Thresh. high red <input checked="" type="checkbox"/> ON <input checked="" type="checkbox"/> OFF	

5.4.5 Menu: Language [Level 2]

Menu path: Main menu/Language/

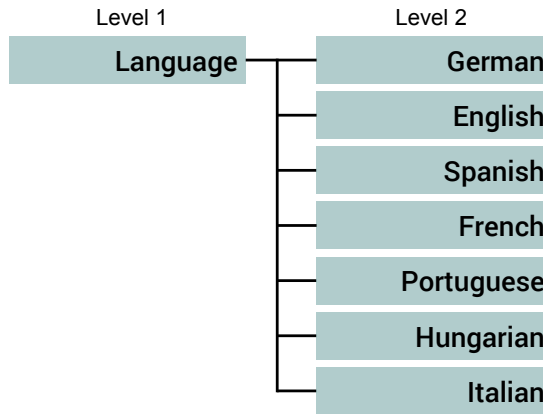

Fig. 109: Menu Language

The menu language can be changed in this menu. A dialogue box opens in which the change needs to be confirmed.

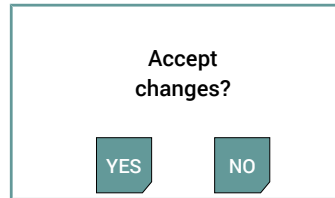

Fig. 110: Dialogue box

5.4.6 Menu: System [Level 2]

Menu path: Main menu/System/

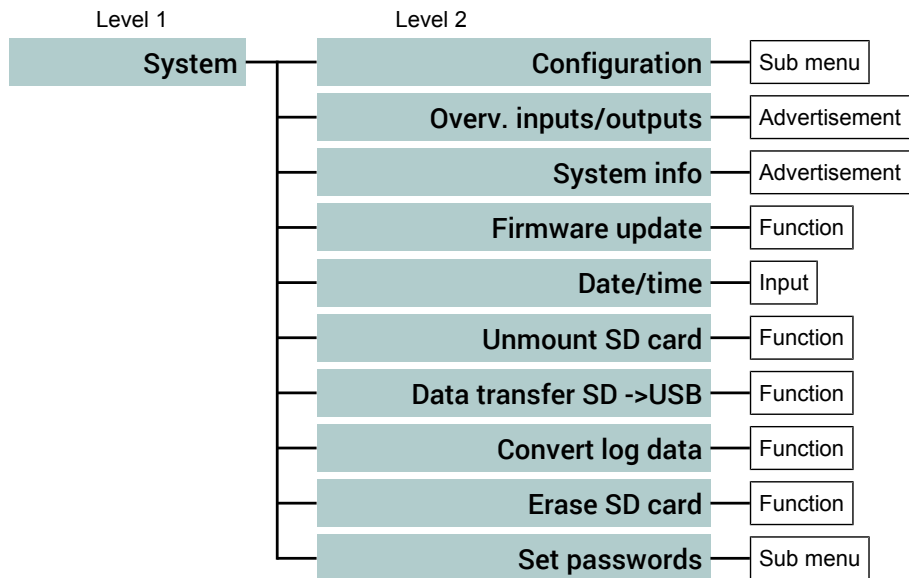

Fig. 111: Menu System

5.4.6.1 Menu: Configuration [Level 3]

Menu path: Main menu/System/Configuration..

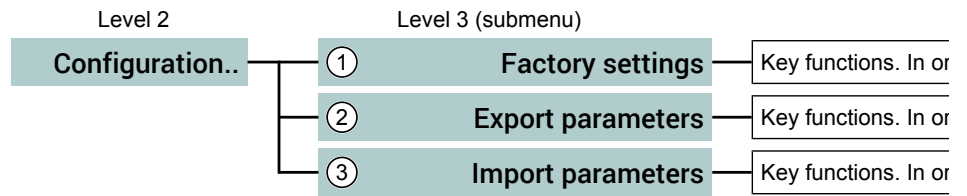

Fig. 112: Menu Configuration..

Pos.	Value range	Description
1	Factory settings	The default settings are restored with this function.
2	Export parameters	This function allows the current parameter values to be exported to an SD card or USB stick.
3	Import parameters	This function allows the saved parameter values to be imported from an SD card or USB stick.

NOTICE! If the parameters are reset to the default settings, these are also affected by the passwords.

The functions **Export/import parameter** serve data backup. They can also be used to transfer configurations from one device to another.

5.4.6.2 Menu: Overview inputs/outputs [Level 3]

Menu path: Main menu/System/Overview inputs/outputs/

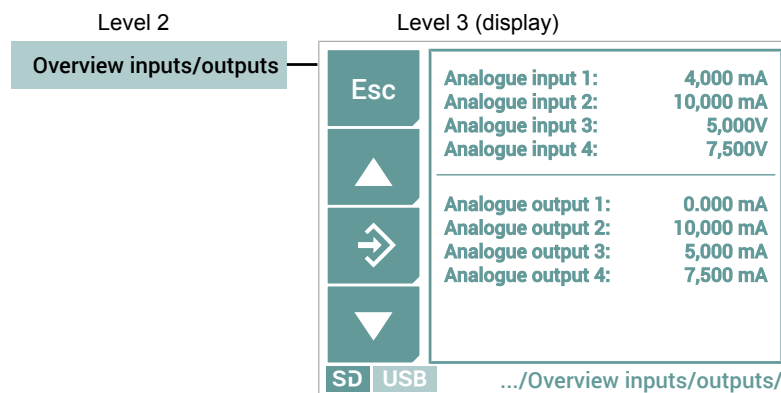

Fig. 113: Menu Overview inputs/outputs

The current status of the inputs and outputs are shown directly on the display. Deactivated analogue inputs and analogue outputs are shown.

Example

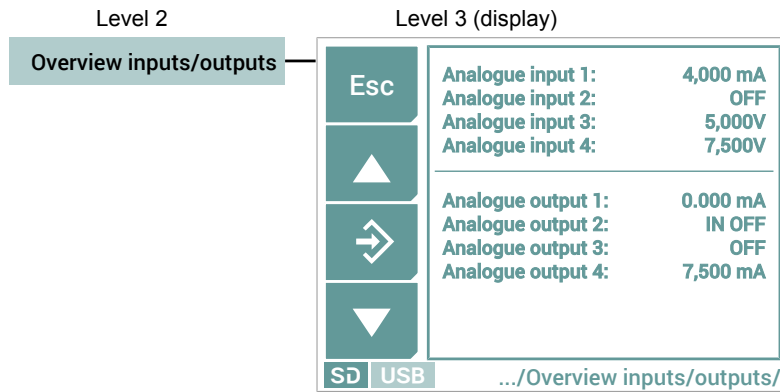

Fig. 114: Menu: Overview inputs/outputs OFF

- Analogue input 2: OFF
This display means that the input has been switched off.
- Analogue input 2: IN OFF
This display means that the input assigned to the output has been switched off.
- Analogue input 3: OFF
This display means that the analogue output has been switched off.

5.4.6.3 Menu: System info [Level 3]

Menu path: Main menu/System/System info/

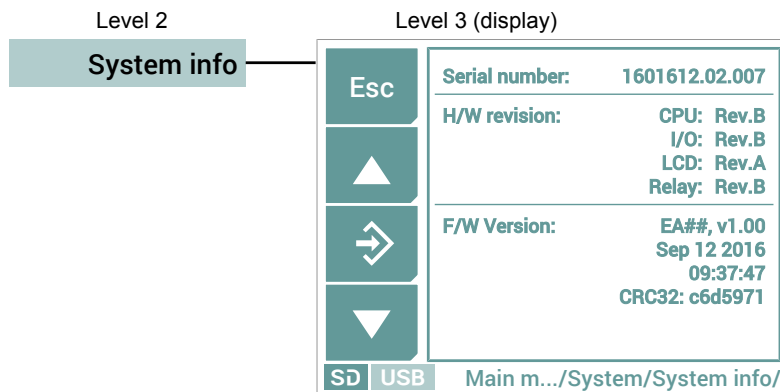

Fig. 115: Menu System info

At this point, the system data for the hardware and firmware of the unit are shown. The presented data serve as an example.

5.4.6.4 Menu: Firmware update [Level 3]

Menu path: Main menu/System/Firmware update/

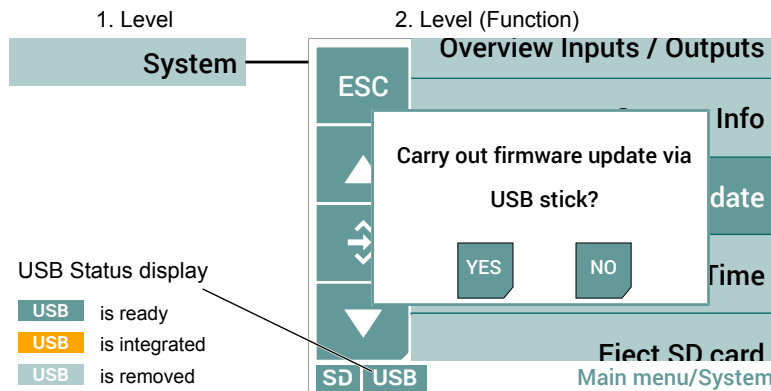

Fig. 116: Menu Firmware update

The firmware can be updated with this function. Before starting the update, the USB stick must be integrated into the system (mounted) As long as the stick is not yet ready, the USB symbol in the status line is shown in yellow. As soon as this process is completed, the backlighting turns to green.

5.4.6.5 Menu: Date/Time [Level 3]

Menu path: Main menu/SystemDate/Time/

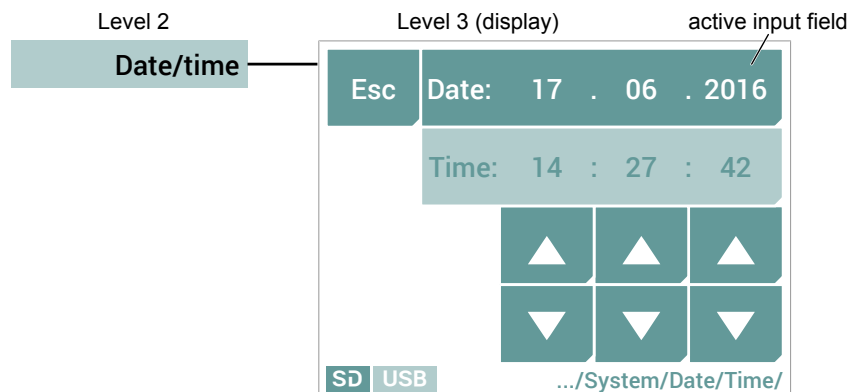

Fig. 117: Menu: Date/Time

The date and time are same way. This is shown using the example of the date.

1. Touch the date field to activate the input field.
2. Use the arrow keys to set the day, month and year. If you keep the button pressed, the respective value changes automatically (repeat function).

5.4.6.6 Menu: Unmount SD card [Level 3]

Menu path: Main menu/System/Unmount SD card/

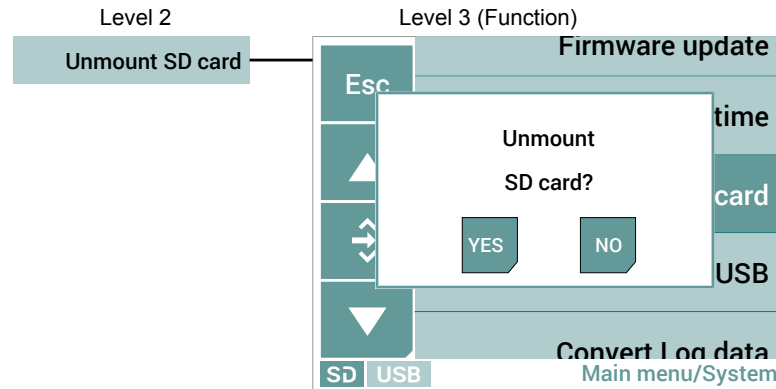

Fig. 118: Menu: Unmount SD card

Unmount SD card

Before the SD card is removed, it must be disconnected from the system. To do this, touch the menu item **Unmount SD card**. The following displayed messages take you through the process.

Import SD card

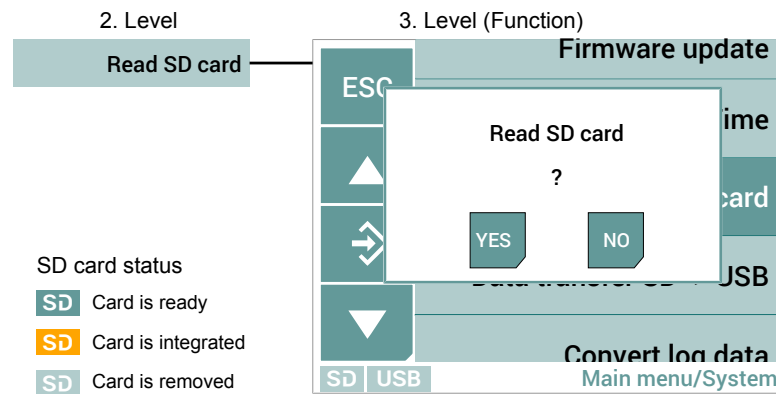

Fig. 119: Menu: Import SD card

Touch the menu item **Import SD card** to import the SD card again. The following displayed messages take you through the process.

5.4.6.7 Menu: Data transfer SD->USB [Level 3]

Menu path: Main menu/System/data transfer SD>USB/

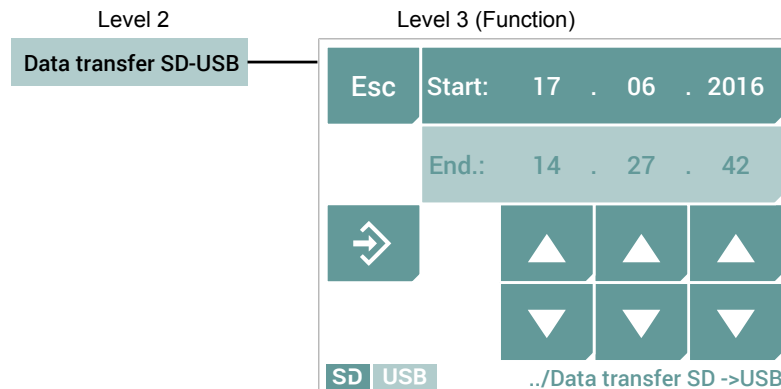
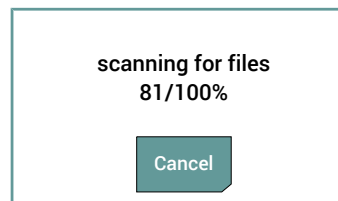

Fig. 120: Menu: Data transfer SD ->USB

This function is used to copy the logger and event data from the SD card to a USB stick. Data transfers can only be performed in a daily basis. The duration of the transfer depends on the configuration of the datalogger. In the case of very large time periods and a high logging rate, the transfer may take a long time. During the transfer process the outputs are 'frozen'.

The transfer is started with the OK button. The following dialogue box appears.



The progress of the transfer process is shown. It is possible to interrupt the transfer process.

5.4.6.8 Menu: Convert log data [Level 3]

Menu path: Main menu/ System/Convert log data/

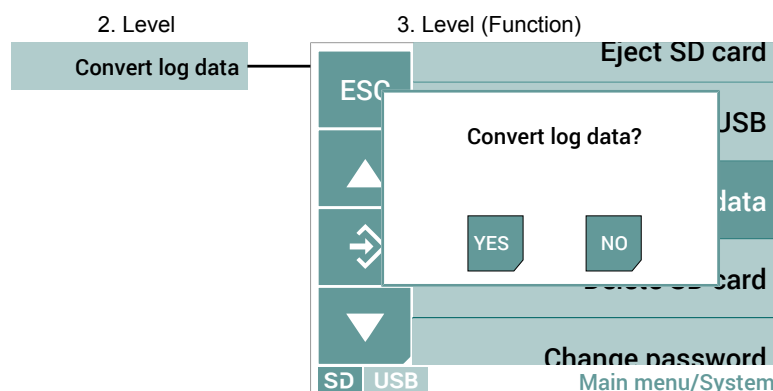

Fig. 121: Menu: Convert log data

As of Firmware V1.5 the log data is saved in a new directory structure to improve performance. After a firmware update, this function converts the data to the new format.

5.4.6.9 Menu: Delete SD card [Level 3]

Menu path: Main menu/ System/Delete SD card/

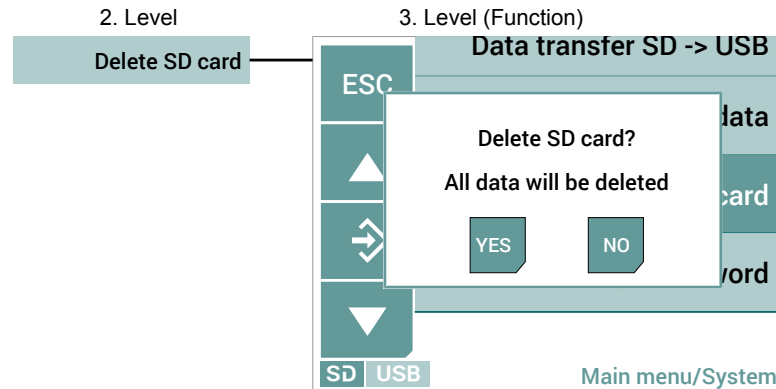

Fig. 122: Menu: Delete SD card

5.4.6.10 Menu: Change passwords [Level 3]

Menu path: Main menu/ System/Change password/

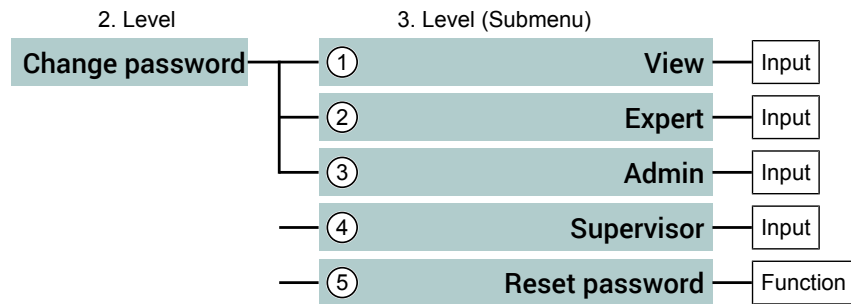

Fig. 123: Menu: Change passwords

Only the supervisor can access all options of this menu. The administrator can only change the passwords for the levels View, Expert and Admin. All other users cannot access this menu.

Pos.	Value range	Description
1	View	Users with 'View' rights only have read rights for the configuration options.
2	Expert	Users with 'Expert' rights may change some configuration options. They have no access to the passwords.
3	Admin	Users with 'Admin' rights may change all the configuration options. They have access to the passwords of the subordinate user levels.
4	Supervisor	Users with 'Supervisor' rights have access to all parameters.
5	Reset passwords	This function is used to reset the passwords to the default settings.

6 Technical data

6.1 Generalities

The stated technical data only refer to the measuring value display unit EA16 and never take into account the properties of the connected measuring transducer.

The EA16 is designed as a component for panel installation and is only supplied fully assembled and wired. Please see the supplied electro-technology documents of the respective panel for information about the electrical connection.

6.2 Input variables

6.2.1 Analogue inputs A1 ... A4

Depending on the model, the measured value display unit EA16 has 2 or 4 analogue inputs for measuring transducers with output signals current of voltage acc. to IEC 60381.

Input range	Min. signal range	Resolution	Input resistance	Overload protection
0 ... 20 mA	4 mA	12 Bit	$\leq 30 \Omega$	PTC max. 32 DC/ 140 mA
4 ... 20 mA	4 mA		$\leq 30 \Omega$	PTC max. 32 DC/ 140 mA
0 ... 10 V	2.5V		$\geq 200 \text{ k}\Omega$	max. 32 V

6.2.2 Digital inputs I/O1 ... I/O4

The number of inputs depends on the number of Flex I/O channels configured as an output. It is configured ex-works and must be stated on the order.

Quantity	Max. 4
Input voltage	5 ... 32 V DC
Switching threshold	ON: 3.9V OFF: 2.6 V Tolerance $\pm 10\%$

6.3 Output parameters

6.3.1 Analogue outputs A1 ... A4

Depending on the model, the measured value display unit EA16 has 2 or 4 analogue outputs with programmable uniform signals acc. to IEC 60381.

Output signal	Min. signal range	Resolution	Signal range
0 ... 20 mA	4 mA	12 Bit	0.0 ... 21.5 mA
4 ... 20 mA	4 mA		0.0 ... 21.5 mA
0 ... 10 V	2.5V		0.0 ... 10.5 V

6.3.2 Digital outputs I/O1 ... I/O4

The number of outputs depends on the number of Flex I/O channels configured as an input. It is configured ex-works and, like the level of output voltage, it must be stated on the order.

Quantity	Max. 4		
Output type	PNP		
Output voltage	5V	12 V	24 V
Output current	20 mA	50 mA	100 mA

6.3.3 Switching outputs K1 ... k4

Depending on the model, the measured value display unit EA16 has none, 2 or 4 switch outputs with a programmable switching function. Optionally, the unit can be supplied with potential-free relay contacts or potential-free semiconductors (MOSFET).

Programmable switching function

Make contact (NO)

Break contact (NC)

Relay contacts

	AC	DC
Max. switching voltage	32V	32V
Max. switching current	2A	2A
Max. switching output	64 VA	64 W

Semiconductor contacts

	AC	DC
Allowed switching voltage	3 ... 32 V	3 ... 32 V
Max. switching current - Peak	1A	1A
Continuous current	0.25A	0.25A
Max. switching output	8 VA	8 W
Forward resistance R_{on}	$\leq 1 \Omega$	$\leq 1 \Omega$

6.4 Measurement accuracy

Characteristic value	Unit	Value
Max. characteristic curve deviation ⁺⁾	% FS	0.10
Typ. characteristic curve deviation ⁺⁾	% FS	< 0.05
Max. temperature coefficient range ^{x)}	% FS/10K	0.10
Typ. temperature coefficient range ^{x)}	% FS/10K	< 0.025
Max. temperature coefficient zero-point ^{x)}	% FS/10K	0.10
Typ. temperature coefficient zero-point ^{x)}	% FS/10K	< 0.025

⁺⁾ Characteristic curve deviation (non-linearity and hysteresis) at 25°C and rated voltage input range with linear, not spread characteristic curve.

^{x)} In relation to the input range with a linear, not spread, characteristic curve.

6.5 Digital interfaces

Type	
USB interface	Micro USB 2.0
SD card slot	Micro SD up to 32 GB
Field bus interface (option)	Modbus RTU
Digital 2-wire interface (option)	FF62 Temperature and moisture sensor

6.6 Display and operating interface

Characteristic value	Value
Display size	3.5"
LCD type	TN TFT
Resolution	320 x 240 Pixel
Touch	Resistive

6.7 Auxiliary energy

Characteristic value	DC	AC
Rated Voltage	24 V DC	24 V AC 50/60Hz
Admissible operating voltage	$U_b = 18 \dots 32$ V DC	24 V AC $\pm 20\%$ 50/60Hz
Power consumption	Max. 11 W	Max. 22 VA
	Type 3 ... 5 W	Type 6 ... 10 VA

6.8 Application conditions

Characteristic value	Value
Permissible ambient temperature	-5 ... +50 °C
Admissible storage temperature	-10 ... +70 °C
Admissible media temperature	see data sheet of the connected measuring transducer
Enclosure protection class	see the electro-technology documents panel (RT#####)
EMC (204/108/EC)	EN 61326-1:2013 EN 61326-2-3:2013
RoHS (2011/65/EU)	EN 50581:2012

6.9 Construction design

Please see the electro-technology documents for information about the panel (RT#####).

7 Order Codes

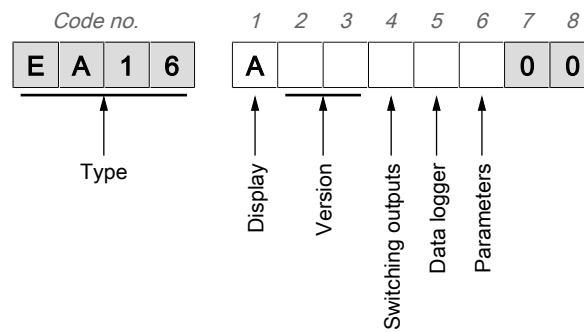

Display	[1]	← Code no.	
	A	3.5" TFT Touch LCD (horizontal)	
Version	[2.3]	← Code no.	
	20	2 channels	(2 inputs, 2 outputs, 2 switch outputs)
	2M	2 channel Modbus	(2 inputs, 2 outputs, 2 switch outputs) + Modbus interface
	40	4 channels	(4 inputs, 4 outputs, 4 switch outputs)
	4M	4 channel Modbus	(4 inputs, 4 outputs, 4 switch outputs) + Modbus interface
Switching outputs	[4]	← Code no.	
	0	without	
	R	with relay contacts	
	H	with semiconductor switches	
Data logger	[5]	← Code no.	
	0	No	
	1	yes (32 GB Micro SD card)	
Parameterization	[6]	← Code no.	
	S	Standard configuration	
	K	Customer-specific configuration	

8 Attachments

8.1 EU Declaration of Conformity



EU Declaration of Conformity

(Translation)

For the product described as follows

Product designation **Measuring value display**

Type designation **EA16**

it is hereby declared that it corresponds with the basic requirements specified in the following designated directives:

- 2014/30/EU EMC Directive
- 2011/65/EU RoHS Directive

The products were tested in compliance with the following standards.

Electromagnetic compatibility (EMC)

- EN 61326-1:2013 Electrical equipment for measurement, control and laboratory use - EMC requirements - Part 1: General requirements
- EN 61326-2-3:2013 Electrical equipment for measurement, control and laboratory use - EMC requirements - Part 2-3: Particular requirements - Test configuration, operational conditions and performance criteria for transducers with integrated or remote signal conditioning

RoHS

- EN 50581:2012 Technical documentation for the assessment of electrical and electronic products with respect to the restriction of hazardous substances

Also they were subjected to the conformity assessment procedure „Internal production control“.

The object of the declaration described above is in conformity with Directive 2011/65/EU of the European Parliament and of the Council of 8 June 2011 on the restriction of the use of certain hazardous substances in electrical and electronic equipment.

Sole responsibility for the issue of this declaration of conformity in relation to fulfilment of the fundamental requirements and the production of the technical documents is with the manufacturer.

Manufacturer **FISCHER Mess- und Regeltechnik GmbH**
 Bielefelder Str. 37a
 32107 Bad Salzufflen, Germany
 Tel. +49 5222 974 0

Documentation representative Mr. Stefan Richter
 Dipl. Ing.
 General Manager R & D

The devices bear the following marking:

Bad Salzufflen,
2016-09-28 S. Richter
 General Manager R & D



Fig. 124: CE_DE_EA16

