

**AE000013**

**ACCESSORIES • MOUNTING**

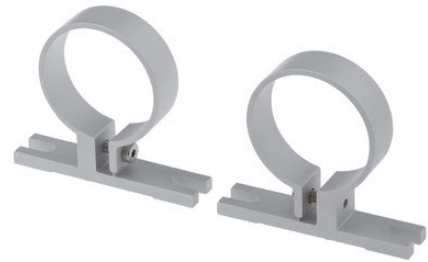

**MECHANICAL DATA**

Angle	90 °
Diameter/width of the fastening holes for sensor	6.5 mm
Height	40.89 mm
Length	29.73 mm
Material	Stainless steel
Mounting type	Screw
Number of boreholes	2
Number of oblong holes	4
Thread pitch	0.7 mm
Thread size, metric	4
Version	Mounting angle bracket
Width	33.78 mm

**OTHER DATA**

Scope of delivery	Mounting material for lights, brackets
-------------------	--

**DIMENSIONAL DRAWING**

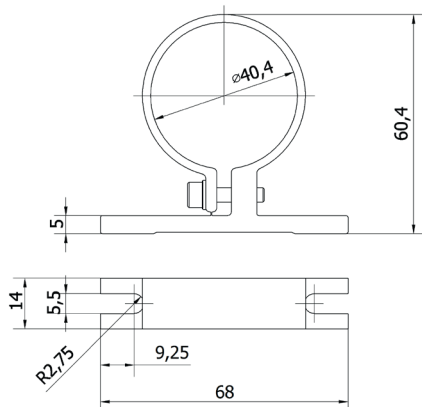

## INSTALLATION



Mounting / Installation may only be carried out by a qualified electrician!

## DISPOSAL



## SAFETY WARNINGS

Before initial operation, please make sure to follow all safety instructions that may be provided in the product information!