

AP000013

ACCESSORIES • MOUNTING



MECHANICAL DATA

Diameter/width of the fastening holes for sensor	4.5 mm
Height	28 mm
Length	30 mm
Material	Aluminium
Mounting type	Screw
Number of boreholes	2
Version	Mounting angle bracket
Weight	30 kg
Width	34 mm

OTHER DATA

Scope of delivery	Precision bracket
-------------------	-------------------

DIMENSIONAL DRAWING

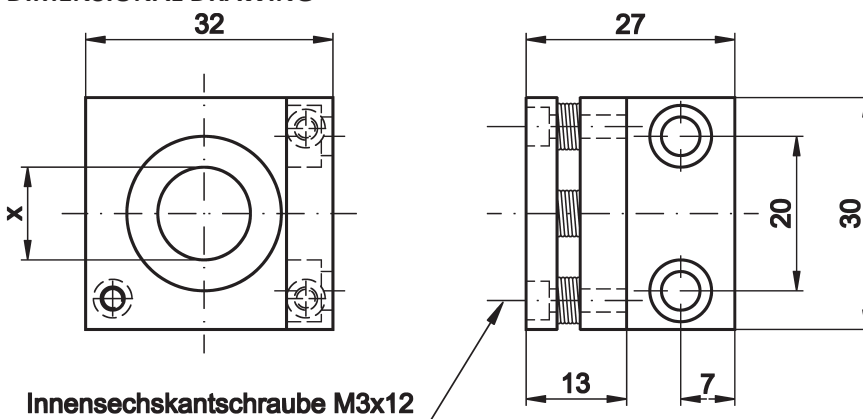

INSTALLATION

DISPOSAL



Mounting / Installation may only be carried out by a qualified electrician!



SAFETY WARNINGS

Before initial operation, please make sure to follow all safety instructions that may be provided in the product information!