

AY000019

ACCESSORIES • MOUNTING



MECHANICAL DATA

For sensor	6.5mm
Material	Aluminium
Mounting type	Screw mounting
Nominal diameter	6.5 mm
Surface	Anodised
To fix to	Wall mounting

OTHER DATA

Suitable for fire protection areas	No
------------------------------------	----

DIMENSIONAL DRAWING

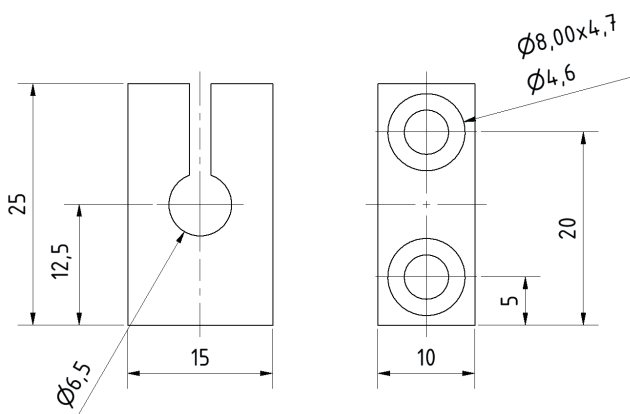

INSTALLATION



Mounting / Installation may only be carried out by a qualified electrician!

DISPOSAL



SAFETY WARNINGS

Before initial operation, please make sure to follow all safety instructions that may be provided in the product information!