

DW343117

PRESSURE SENSORS • CONNECTION G1/8" OUTER THREAD

Pressure sensors are suitable for measuring different media with high accuracy. They are available with switching output and/or analog output. Using PC software, the measured values can be recorded depending on the device type. These sensors can be used in all areas of e.g. pneumatic and hydraulic applications.



MECHANICAL DATA

Ambient temperature	-20 °C ... 80 °C
Bursting pressure	2200 bar
Degree of protection (IP)	IP65
Explosion-proof	No
For gaseous media	Yes
For liquid media	Yes
For pasty media	Yes
Front-flush membrane	Yes
Housing design	Cylinder plain
Housing material	PA 6.6 (synthetic)
Max. operating pressure	900000 hPa
Max. operating pressure	900 bar
Medium temperature	-20 °C ... 80 °C
Nominal pressure	600 bar
Sensing element material	Stainless steel 1.4435
Sensor diameter	38 mm
Sensor length	122 mm
Thread length	12 mm
Thread pitch	1.81 mm
Type of pressure connection	G1/2 inch A
With hand operation	No

ELECTRICAL DATA

Adjustable hysteresis	Yes
Damping (analog output) MAX	20 s
Damping (displayed value) MAX	20 s
Decay time	5 ms
Electronic version	Yes
End setting	300000 hPa ... 600000 hPa
End value measuring range, pressure	60000000 Pa
Hysteresis	1 %

ELECTRICAL DATA

Initial setting	0 hPa ... 300000 hPa
Initial value of measuring range, pressure	0 Pa
IO-Link compatible	No
Max. output current	1000 mA
Measurement method	Absolute
Measuring range pressure (MAX)	600 bar
No-load current	60 mA
Number of pins	4
Number of switching outputs	2
Operating voltage	12 V ... 32 V
Peak value memory	Yes
Programmable via software	Yes
Rated operating voltage U _e at DC	12 V ... 32 V
Readiness delay	2000 ms
Relative linearity deviation	0.25 %
Relative repeat accuracy	0.1 %
Response time	5 ms
Reverse polarity protection	Yes
Setting procedure	Parameterization
Short-circuit-proof	Yes
Suitable as 2-point control	Yes
Suitable as limiter	Yes
Suitable as monitor	Yes
Switching frequency	125 Hz
Switching output with window function	Yes
Temperature drift	0.2 %
Turn-off delay	20 s
Turn-on delay	20 s
Type of alarm output	PNP
Type of analog output	0 V ... 10 V / 4 mA ... 20 mA / 0 ... 20 mA
Type of electrical connection	Plug-in connection M12
Type of switching function	Normally closed contact/normally open contact
Type of switching output	PNP
Voltage drop	2 V
Voltage type	DC
With display	Yes
With LED display	Yes
With manual on/off switch	No
OTHER DATA	
For hydraulic applications	Yes
For pneumatic applications	Yes
Measuring display	Relative

CONNECTION

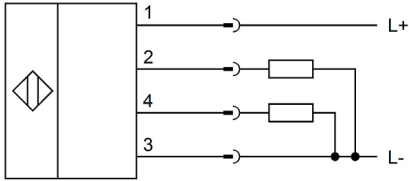

Colors: 1 = BN (brown), 2 = WH (white), 3 = BU (blue), 4 = BK (black)

Functions: 1 = L+, 2 = PNP NO/NC, alarm, analog, 3 = L-, 4 = PNP NO/NC

DIMENSIONAL DRAWING

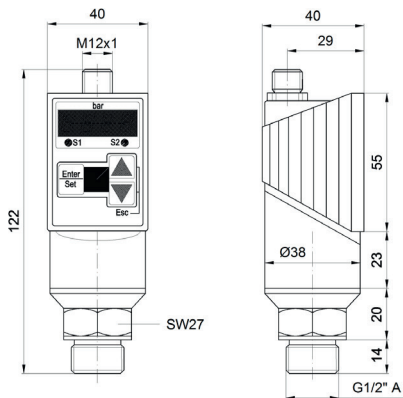

INSTALLATION



Mounting / Installation may only be carried out by a qualified electrician!

DISPOSAL



SAFETY WARNINGS

Before initial operation, please make sure to follow all safety instructions that may be provided in the product information!