

LS150311

FIBER OPTIC SENSORS • FIBER OPTICS GLASS FIBERS

Fiber optics in combination with the appropriate fiber optic amplifier function as contactless and wear-free position switches that can also be used in harsh environmental conditions. They detect objects independent of their characteristics (e.g., shape, color, surface structure, material). Because the ends and heads of the fiber optics have small dimensions and the fiber optics are flexible, very elegant solutions can be created for detecting objects in places that are difficult to access. Fiber optics can be used without special precautions in potentially explosive areas and in zones with electrical and/or magnetic fields (high-voltage installations, electrical welding equipment) as their function is not thereby affected. Fiber optics are available in versions for implementing the function as through-beam sensor or diffuse reflection sensor.



MECHANICAL DATA

Ambient temperature	-40 °C ... 180 °C
Bending radius (fixed)	25 mm
Bending radius (flexible)	50 mm
Degree of protection (IP)	IP67
Ejection control	Yes
End piece length	15 mm
Fiber diameter	6.7 mm
Fiber optics core material	Glass
Heavy soiling	Yes
Housing design	Cylinder plain
Housing material	Stainless steel
Increased ambient temperature ≤ 180°C	Yes
Material of cable sheath	Silicone
Number of fibers	2
Overall length	1500 mm
Punching tools	Yes
Sensing head diameter	4 mm
Sheathing material	Stainless steel inner helix/braided glass fibers
Strong vibration / motion	Yes
Type of mechanical connection	Screw connection M18
Version	Through-beam sensors

ELECTRICAL DATA

Analogue output 0 mA ... 20 mA	No
Analogue output 0 V ... 10 V	No
Analogue output -10 V ... +10 V	No
Analogue output 4 mA ... 20 mA	No
Bending angle of the sensing head	90 °
Light exit	Axial

ELECTRICAL DATA

Max. switching distance	500 mm
Sensing head length	37 mm
With blanking function	No

OPTICAL DATA

Range	500 mm
-------	--------

OTHER DATA

Feeding technology	Yes
--------------------	-----

DIMENSIONAL DRAWING

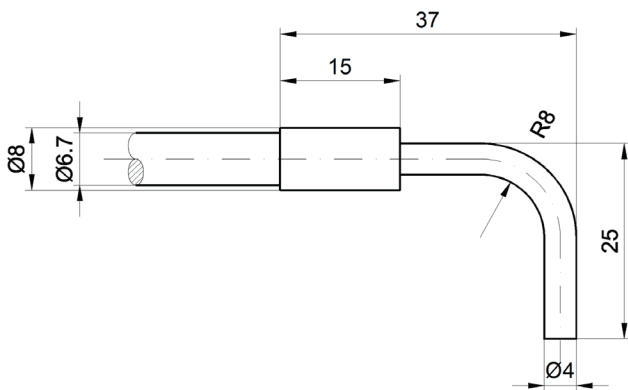

INSTALLATION



Mounting / Installation may only be carried out by a qualified electrician!

DISPOSAL



SAFETY WARNINGS

Before initial operation, please make sure to follow all safety instructions that may be provided in the product information!