

OS130075

OPTICAL SENSORS • THROUGH-BEAM SENSORS TRANSMITTERS

Optical sensors function contactlessly. They detect objects independent of their characteristics (e.g., shape, color, surface structure, material). The basic operating principle is based on the transmission and reception of light. There are three different versions: 1. The through-beam sensor consists of two separate devices, a transmitter and a receiver that are aligned with one another. If the light beam between the two devices is interrupted, the switching output integrated in the receiver changes its status. 2. With the retro-reflective sensor, the transmitter and receiver are located in one device. The emitted light beam is reflected back to the receiver by a reflector that is to be mounted opposite the device. As soon as the light beam is interrupted, the switching output integrated in the device changes its status. 3. With the diffuse reflection sensor, the transmitter and receiver are in one device. The emitted light beam is reflected by the object that is to be detected. As soon as the receiver detects the reflected light, the switching output integrated in the device changes its status.



MECHANICAL DATA

Ambient temperature	-5 °C ... 70 °C
Degree of protection (IP)	IP65
Housing coating	Nickel-plated
Housing design	Cuboid
Housing material	Brass
Increased ambient temperatures >70°C	Yes
Material of optical surface	Plastic
Sensor height	64 mm
Sensor length	12 mm
Sensor width	12 mm

ELECTRICAL DATA

Function test	Yes
IO-Link compatible	No
Measuring range	6 m
No-load current	30 mA
No-load current, transmitter	30 mA
Number of pins	3
Operating voltage	10 V ... 35 V
Rated switching distance	6000 mm
Readiness delay	15 ms
Reverse polarity protection	Yes
Type of electrical connection	Connector M8
Type of input voltage	DC
Voltage type	DC
With LED display	Yes
With LED display (signal)	Yes

ELECTRICAL DATA

With time function No

OPTICAL DATA

Light beam form	Point
Light source	Infrared light
Wavelength of the sensor	880 nm

OTHER DATA

Scope of delivery of the one-way system	Transmitter
---	-------------

DIMENSIONAL DRAWING

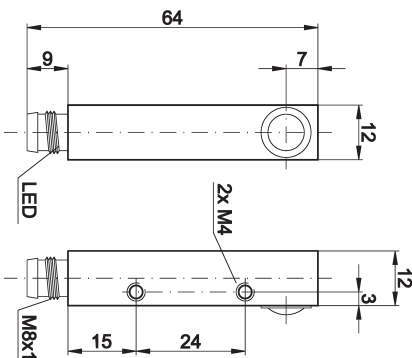

INSTALLATION



Mounting / Installation may only be carried out by a qualified electrician!

DISPOSAL



SAFETY WARNINGS

Before initial operation, please make sure to follow all safety instructions that may be provided in the product information!