

OT170423

OPTICAL SENSORS • DIFFUSE REFLECTION SENSORS WITH BACKGROUND SUPPRESSION

Optical sensors function contactlessly. They detect objects independent of their characteristics (e.g., shape, color, surface structure, material). The basic operating principle is based on the transmission and reception of light. There are three different versions: 1. The through-beam sensor consists of two separate devices, a transmitter and a receiver that are aligned with one another. If the light beam between the two devices is interrupted, the switching output integrated in the receiver changes its status. 2. With the retro-reflective sensor, the transmitter and receiver are located in one device. The emitted light beam is reflected back to the receiver by a reflector that is to be mounted opposite the device. As soon as the light beam is interrupted, the switching output integrated in the device changes its status. 3. With the diffuse reflection sensor, the transmitter and receiver are in one device. The emitted light beam is reflected by the object that is to be detected. As soon as the receiver detects the reflected light, the switching output integrated in the device changes its status.



MECHANICAL DATA

Ambient temperature	-25 °C ... 65 °C
Degree of protection (IP)	IP67
Housing design	Cuboid
Housing material	Zinc die-cast
Material of optical surface	PMMA
Reflector included in the scope of delivery	No
Sensor height	50 mm
Sensor length	50 mm
Sensor width	15.4 mm

ELECTRICAL DATA

Adjustment range	20 mm ... 600 mm
Analogue output 0 mA ... 20 mA	No
Analogue output 0 V ... 10 V	No
Analogue output -10 V ... +10 V	No
Analogue output 4 mA ... 20 mA	No
Decay time	5 ms
Interference suppression	Yes
IO-Link compatible	No
Max. output current	200 mA
Max. switching distance	600 mm
No-load current	41 mA
Number of pins	4
Number of switching outputs	2
Operating voltage	10 V ... 30 V
Rated switching distance	600 mm
Response time	5 ms

ELECTRICAL DATA

Reverse polarity protection	Yes
Scanning function	Light-/dark-on mode
Sensing range	20 mm ... 600 mm
Setting procedure	Manual adjustment
Short-circuit-proof	Yes
Switching frequency	500 Hz
Type of electrical connection	Connector M12
Type of switching function	Anticoincidence
Type of switching output	PNP
Voltage drop	1.8 V
Voltage type	DC
With LED display	Yes
With LED display (signal)	Yes
With other analog output	No

OPTICAL DATA

Background suppression	Yes
Light beam form	Point
Light source	Polarity free red light
Triangulation	Background suppression
Wavelength of the sensor	660 nm

CONNECTION

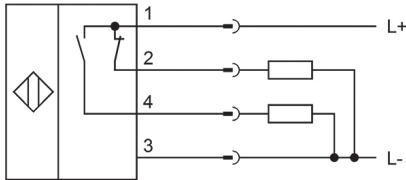

Colors: 1 = BN (brown), 2 = WH (white), 3 = BU (blue), 4 = BK (black)

Functions: 1 = L+, 2 = pnp/nc, 3 = L-, 4 = PNP NO

DIMENSIONAL DRAWING

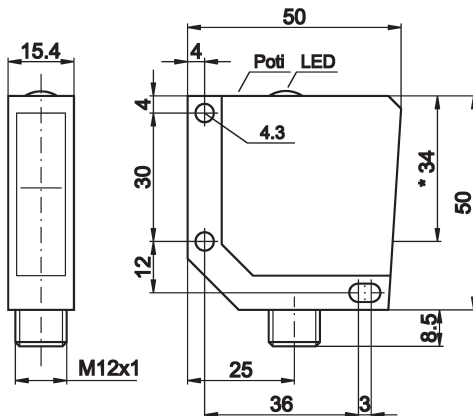

INSTALLATION

DISPOSAL



Mounting / Installation may only be carried out by a qualified electrician!



SAFETY WARNINGS

Before initial operation, please make sure to follow all safety instructions that may be provided in the product information!