

PT660022

LASER SENSORS • DISTANCE MEASUREMENT

Optical sensors function contactlessly. They detect objects independent of their characteristics (e.g., shape, color, surface structure, material). The basic operating principle is based on the transmission and reception of light. There are three different versions: 1. The through-beam sensor consists of two separate devices, a transmitter and a receiver that are aligned with one another. If the light beam between the two devices is interrupted, the switching output integrated in the receiver changes its status. 2. With the retro-reflective sensor, the transmitter and receiver are located in one device. The emitted light beam is reflected back to the receiver by a reflector that is to be mounted opposite the device. As soon as the light beam is interrupted, the switching output integrated in the device changes its status. 3. With the diffuse reflection sensor, the transmitter and receiver are in one device. The emitted light beam is reflected by the object that is to be detected. As soon as the receiver detects the reflected light, the switching output integrated in the device changes its status.



MECHANICAL DATA

Ambient temperature	0 °C ... 50 °C
Degree of protection (IP)	IP67
Housing design	Cuboid
Housing material	Zinc die-cast
Material of optical surface	Glass
Sensor height	65 mm
Sensor length	50 mm
Sensor width	20.6 mm

ELECTRICAL DATA

Absolute linearity deviation	1 mm
Alarm output	Yes
Decay time	0.9 ms
IO-Link compatible	No
Max. output current	100 mA
Measuring method for optical distance measurement	Triangulation
Measuring range length	50 mm ... 300 mm
No-load current	100 mA
Number of pins	8
Response time	0.9 ms
Response/decay time	0.9 ms
Reverse polarity protection	Yes
Scanning principle	Push button
Setting procedure	Teach-In
Short-circuit-proof	Yes
Supply voltage	12 V ... 28 V
Type of alarm output	PNP

ELECTRICAL DATA

Type of analog output	0 V ... 10 V / 4 mA ... 20 mA
Type of electrical connection	Connector M12
Voltage type	DC
With LED display	Yes

OPTICAL DATA

Geometrical resolution	0.33 mm
Laser protection class	Class 2
Light beam form	Point
Light source	Laser diode, red light
Light spot, laser focus	3.14 mm ²
Resolution	0.33 mm
Small light beam diameter	Yes
Teach-in limits distance	5 mm
Wavelength of the sensor	650 nm

OTHER DATA

Relative linearity deviation	1 %
------------------------------	-----

CONNECTION

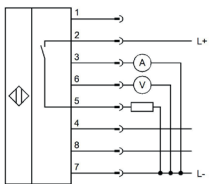

Colors: 1 = WH (white), 2 = BN (brown), 3 = GN (green), 4 = YE (yellow), 5 = GY (gray), 6 = PK (pink), 7 = BU (blue), 8 = RD (red)

Functions: 1 = n. c., 2 = L+, 3 = 4-20mA, 4 = teach-In, 5 = alarm, 6 = 0-10V, 7 = L-, 8 = sync.

DIMENSIONAL DRAWING

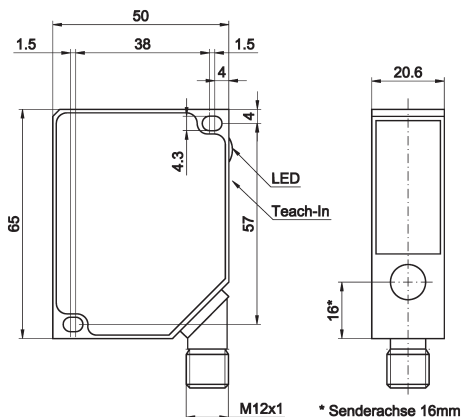

INSTALLATION

DISPOSAL



Mounting / Installation may only be carried out by a qualified electrician!



SAFETY WARNINGS

Before initial operation, please make sure to follow all safety instructions that may be provided in the product information!