

SS906020

FLOW SENSORS • SENSORS FOR WATER

The function of the flow sensor is based on the calorimetric principle. The probe is heated up from the inside a few degrees Celsius in relation to the flow medium, in which it protrudes. When the medium flows, the heat generated in the probe is dissipated through the medium. The temperature within the sensor is measured and compared with the likewise measured medium temperature. From the obtained temperature difference the flow state of each medium can be derived. These sensors are applied in areas such as monitoring of cooling systems, ventilation systems, pump dry running by checking the presence of liquid or gas flows.



MECHANICAL DATA

Degree of protection (IP) of evaluation electronics	IP67
Degree of protection (IP) of measuring head	IP67
Housing design	Cylinder, screw-thread
Housing material	Stainless steel V4A
Pressure resistance	100 bar
Thread length	48 mm
Type of process connection	G1/2 inch

ELECTRICAL DATA

Adjustable responding value for flow for liquids	0.01 m/s ... 3 m/s
Flow range for oil	3 m/s
Flow range for oil	0.03 m/s
Flow range for water	1.5 m/s
Flow range for water	0.01 m/s
IO-Link compatible	No
Max. line length	100 m
Measuring principle of flow	Calorimetric
Number of pins	4
Pressure resistance of measuring head	100 bar
Readiness delay	15 ms
Response time	13000 ms
Temperature setting	20 °C ... 100 °C
Turn-off delay	25 s
Type of electrical connection	Plug-in connection M12

OTHER DATA

Cooling water circuits	Yes
For hydraulic applications	Yes
Suitable for gases	No
Suitable for liquids	Yes

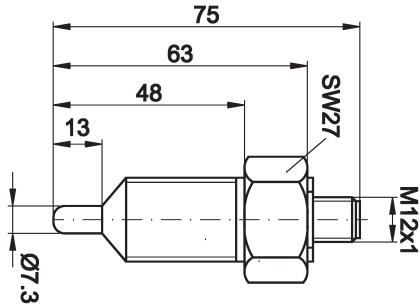
DIMENSIONAL DRAWING**INSTALLATION**

Mounting / Installation may only be carried out by a qualified electrician!

DISPOSAL**SAFETY WARNINGS**

Before initial operation, please make sure to follow all safety instructions that may be provided in the product information!