

## VL600104

### CONNECTION TECHNOLOGY • LOGIC MODULES

Connecting digital signals directly at the machine can contribute to significant cost and effort minimization. A classic application is the linking of different signals directly in the field. Thus, it is possible to avoid long line paths of many individual devices, which significantly reduces the wiring effort and the need for control inputs. All input signals on the logic modules are visualized by integrated LED and are electrically decoupled from each other. In this way, influences from one device to the other are reliably prevented. The outputs of the modules are overload-proof and the upcoming signal is also indicated by an LED. In addition to logical input signal connections such as AND and OR, versions with signal change control are also available. The ipf logic modules are available for DIN rail mounting or as field modules. Therefore and because of the robust housing, which is characterized by a high degree of protection against the penetration of dust and water, our devices can be used in all areas of machines, equipment and tools.



#### MECHANICAL DATA

Ambient temperature	-20 °C ... 70 °C
Degree of protection (IP)	IP67
Depth	41.5 mm
Expandable	No
Front installation possible	No
Height	122 mm
Housing material	Plastic
Rack-mounting possible	No
Rail mounting possible	No
Wall/direct mounting possible	No
Width	60 mm

#### ELECTRICAL DATA

ASI protocol supported	No
AS-Interface Safety at Work protocol supported	No
Base device	No
CAN protocol supported	No
Data-Highway protocol supported	No
DeviceNet protocol supported	No
DeviceNet Safety protocol supported	No
EtherNet/IP protocol supported	No
Expansion device	No
Foundation Fieldbus protocol supported	No
INTERBUS protocol supported	No
INTERBUS-Safety protocol supported	No
IO-Link master	No
KNX protocol supported	No
Logic	AND

**ELECTRICAL DATA**

LON protocol supported	No
Max. output current	0.2 A
MODBUS protocol supported	No
Number of inputs per logic unit	4
Number of logic units	1
Number of pins	4
Number of pins of connections, control side	4
Number of pins of connections, sensor side	4
Number of sensor connection positions	4
Other bus systems are supported	No
PROFIBUS protocol supported	No
PROFINET CBA protocol supported	No
PROFINET IO protocol supported	No
PROFIsafe protocol supported	No
Radio standard Bluetooth	No
Radio standard GPRS	No
Radio standard GSM	No
Radio standard UMTS	No
Radio standard WLAN 802.11	No
Redundancy capability	No
SafetyBUS p protocol supported	No
SUCONET protocol supported	No
Suitable for safety functions	No
Supply voltage at DC	10 V ... 30 V
TCP/IP protocol supported	No
Type of electrical connection, control side	M12-connector
Type of electrical connection, sensor side	Connector M12
Voltage type of supply voltage	DC
With display	No
With LED display	Yes
With optical interface	No
With relay output	No

**OTHER DATA**

Corresponding equipment (Ex ia)	No
Corresponding equipment (Ex ib)	No
SERCOS protocol supported	No
With timer clock	No

## DIMENSIONAL DRAWING

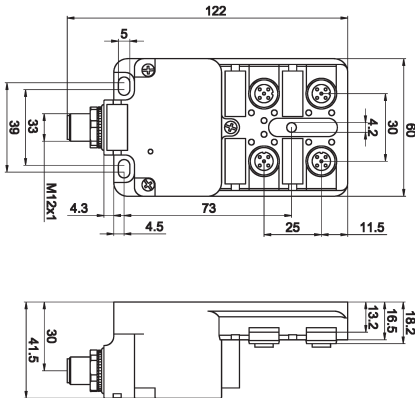

## INSTALLATION



Mounting / Installation may only be carried out by a qualified electrician!

## DISPOSAL



## SAFETY WARNINGS

Before initial operation, please make sure to follow all safety instructions that may be provided in the product information!