



### Model Number

**V1-W-A2-5M-PUR**

Cable socket, M12, LED, 4-pin, PUR cable

### Features

- Built-in LED, as operating and function indicator
- Knurled nut suitable for tool assembly
- Immunity to vibration, with mechanical latching
- Gold plated contacts
- Degree of protection IP67 / IP68 / IP69K
- Halogen-free

### Dimensions

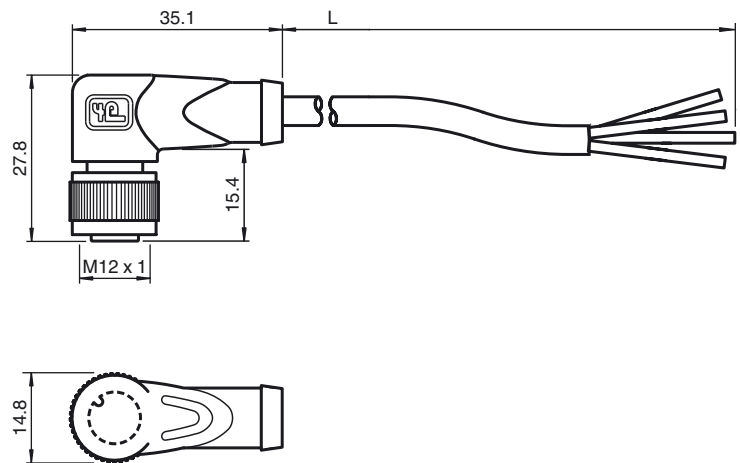

### Technical data

#### General specifications

Number of pins	4
----------------	---

#### Indicators/operating means

LED green	Operating display
LED yellow	Functional display NO contact

#### Electrical specifications

Operating voltage	$U_B$	max. 24 V DC $\pm$ 15%
Operating current	$I_B$	max. 4 A
Contact resistance		< 10 m $\Omega$

#### Ambient conditions

Ambient temperature	-25 ... 100 °C (-13 ... 212 °F) for temperatures over 80 °C (176 °F) reduced elongation at tear
Pollution degree	3

#### Mechanical specifications

Contact elements	spring-loaded contact socket
Pin diameter	1 mm
Degree of protection	IP67 / IP68 / IP69k
Material	
Contacts	CuSn / Au
Contact surface	Au
Body	TPU, transparent
Cable	PUR
Slotted nut	Diecast zinc
Core insulation	PP
Cable	fine-strand, flexible
Sheath diameter	$\varnothing$ 4.8 mm
Bending radius	> 10 x cable diameter, moving
Color	grey
Cores	4 x 0.34 mm <sup>2</sup>
Conductor construction	19 x 0.15 mm $\varnothing$
Length	L 5 m
Flammability	
Contact carrier	94 HB
Housing	94 V-2

#### Compliance with standards and directives

Standard conformity	
Degree of protection	EN 60529:2000
Standards	IEC 61076-2-101:2008

### Electrical connection

