



**Model Number**

**SLPC10-2/31**

with 2 relay outputs with two force-guided normally open contacts

**Features**

- Sensing range up to 10 m
- 2-radial design
- Beam spacing 500 mm
- Self-monitoring (type 4 according to IEC/EN 61496-1)
- Red transmission light
- Usable with or without start/restart disable
- Integrated relay monitor
- 7-segment diagnostic display
- Integrated function display
- Pre-fault indication
- OSSD outputs as semiconductor or relay outputs

**Accessories**

**PG SLP-2**

Protective glass panes for SLP series

**Dimensions**

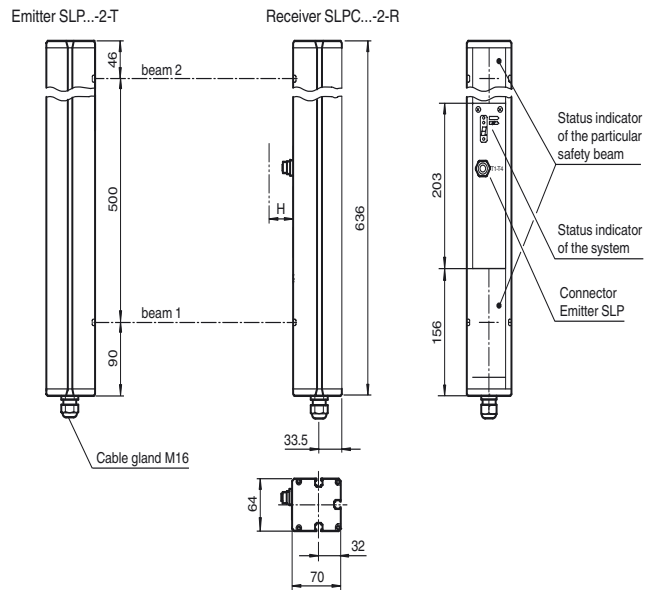

**Electrical connection**

Emitter SLP

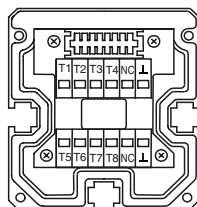

- T1 - Emitter channel 1
- T2 - Emitter channel 2
- ⊥ - 0 V

Receiver SLPC

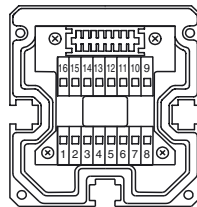

Receiver SLPC (semiconductor outputs)	Receiver SLPC/31 (Relay outputs)
4 - n.c.	1 - Functional earth
5 - -	2 - 0 V
6 - +	3 - 24 V
7 - OSSD 1	4 - [Relay symbol]
8 - OSSD 2	5 - [Relay symbol]
	6 - [Relay symbol]
	7 - [Relay symbol]
	8 - [Relay symbol]
	9 - Input, Relay monitor
	10 - Input, Start release
	11 - Input, Reset
	12 - PNP-output, Soiled optics
	13 - n.c.
	14 - PNP-output, Startup readiness
	15 - PNP-output, Indicator OSSD OFF
	16 - PNP-output, Indicator OSSD ON

Release date: 2018-01-03 09:04 Date of issue: 2018-01-03 11:18:53\_eng.xml

**Technical data****System components**

Emitter	SLP10-2-T
Receiver	SLPC10-2-R/31

**General specifications**

Effective detection range	0.2 ... 10 m
Light source	LED
Light type	modulated visible red light
Tests	IEC/EN 61496
Safety type according to IEC/EN 61496	4
Marking	CE
Target size	static: 32 mm dynamic: 50 mm (at v = 1.6 m/s of the obstacle)
Beam spacing	500 mm
Number of beams	2
Operating mode	Start/restart disable, relay monitor,
Angle of divergence	< 5 °

**Functional safety related parameters**

Performance level (PL)	PL e
Category	Cat. 4
Mission Time (T <sub>M</sub> )	20 a
PFH <sub>d</sub>	3.54 E-9
B <sub>10d</sub>	see instruction manuals
Type	4

**Indicators/operating means**

Diagnostics indicator	7-segment display
Function indicator	LED red: per receiver channel off: interruption flashes: receiver continuously on: reception with sufficient stability control on the front plate: LED red: OSSD off LED green: OSSD on
Pre-fault indicator	LED red next to receiver flashes
Control elements	10 DIP switch in receiver terminal compartment

**Electrical specifications**

Operating voltage	U <sub>B</sub>	24 V DC -15% / +25% , galvanically isolated
No-load supply current	I <sub>0</sub>	max. 250 mA
Protection class		III , IEC 61140

**Input**

Activation current	approx. 10 mA
Activation time	0.03 ... 1 s
Test input	Reset-input for system test
Function input	Relay monitor, start release

**Output**

Pre-fault indication output	1 PNP, +U <sub>B</sub> -2 V, max. 300 mA
Safety output	2 relay outputs, force-guided NO-contact
Signal output	1 PNP each, max. 300 mA for start readiness, OSSD on, OSSD off
Switching voltage	20 ... 60 V DC, 12 ... 25 V AC <sub>rms</sub>
Switching current	0.01 ... 2 A
Switching power	100 VA
Response time	40 ms

**Conformity**

Functional safety	ISO 13849-1
Product standard	EN 61496-1 ; IEC 61496-2

**Ambient conditions**

Ambient temperature	0 ... 50 °C (32 ... 122 °F)
Storage temperature	-20 ... 70 °C (-4 ... 158 °F)
Relative humidity	max. 95 % , not condensing

**Mechanical specifications**

Degree of protection	IP65
Connection	M16 cable gland , terminal compartment with cage-terminals, M12-connector for emitter
Connection options	Further electrical connection options on request: Connector DIN 43 651 Hirschmann, emitter: 6-pin+PE, receiver: 11-pin+PE
Material	
Housing	extruded aluminum profile, RAL 1021 (yellow) coated
Optical face	Plastic pane
Mass	Per 2300 g

**Approvals and certificates**

CE conformity	CE
CCC approval	CCC approval / marking not required for products rated ≤36 V
Approvals	TÜV

Curves/Diagrams

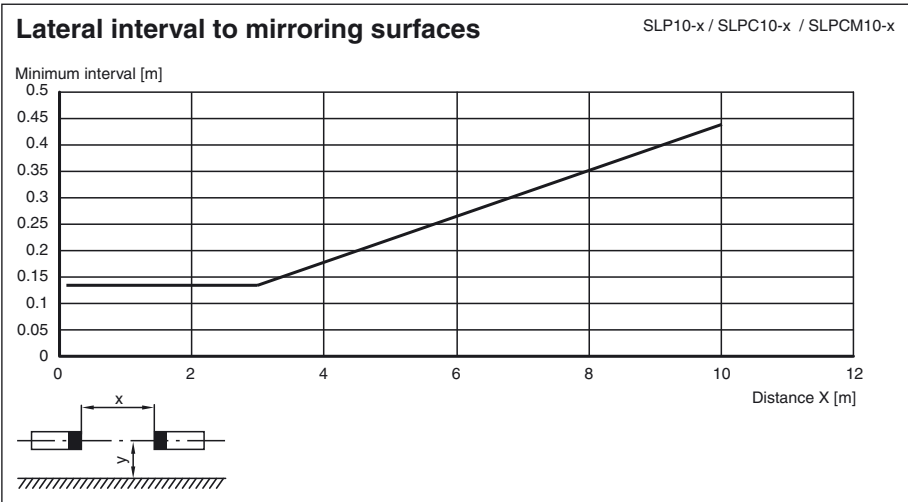
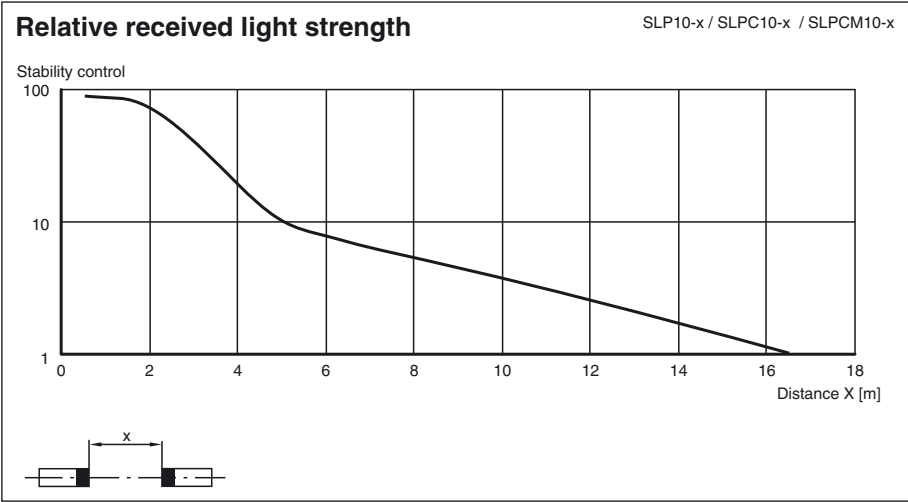
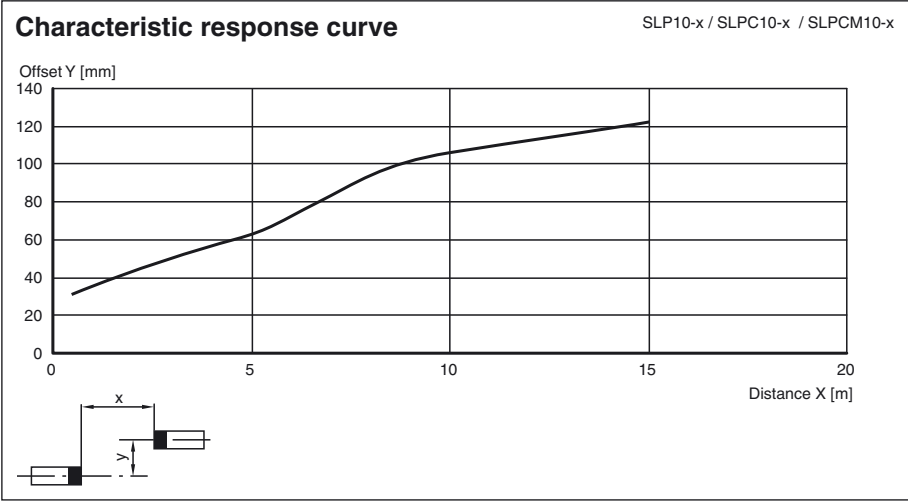

Release date: 2018-01-03 09:04 Date of issue: 2018-01-03 11:18:53\_eng.xml

**Additional information**

**Socket assignment on the front side of the device**

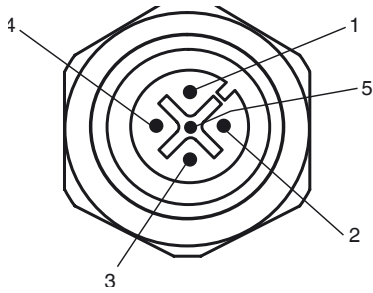

T1 - T4 transmitter control

Socket	Function
1	Transmitter channel 1
2	Transmitter channel 2
3	0 V

**System accessories**

- Mounting set MS SLP
- Profile alignment aid PA SLP/SLC
- Laser alignment aid BA SLP
- Ground pillar UC SLP/SLC
- Housing for pillar Enclosure UC SLP/SLC
- Collision protector Damping UC SLP/SLC
- Redirection mirror for multi-side protection of hazardous areas SLP-2-M

Release date: 2018-01-03 09:04 Date of issue: 2018-01-03 11:18:53\_eng.xml