

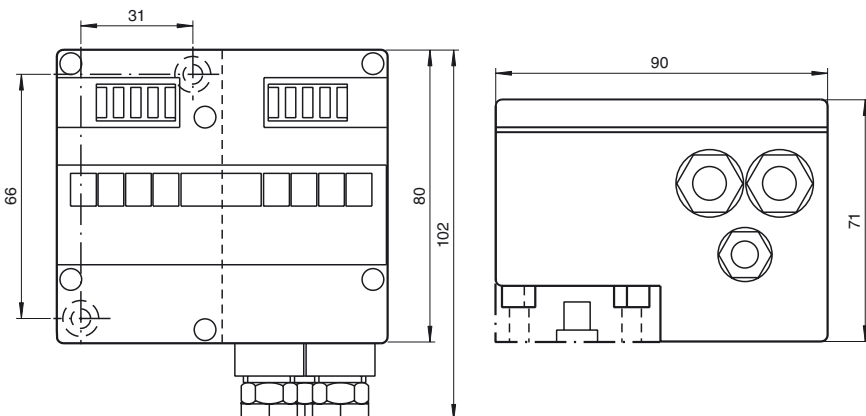

Dimensions



Electrical connection

Model number

VBA-2A-G4-U

G4 module IP65
2 analog outputs (voltage)

Features

- Degree of protection IP65
- Flat or round cable connection (via standardized EEMS base, not included with delivery)
- Cable piercing method for flat cable
- Function display for bus, external auxiliary voltage and outputs
- Power supply of outputs external or from the module, as required

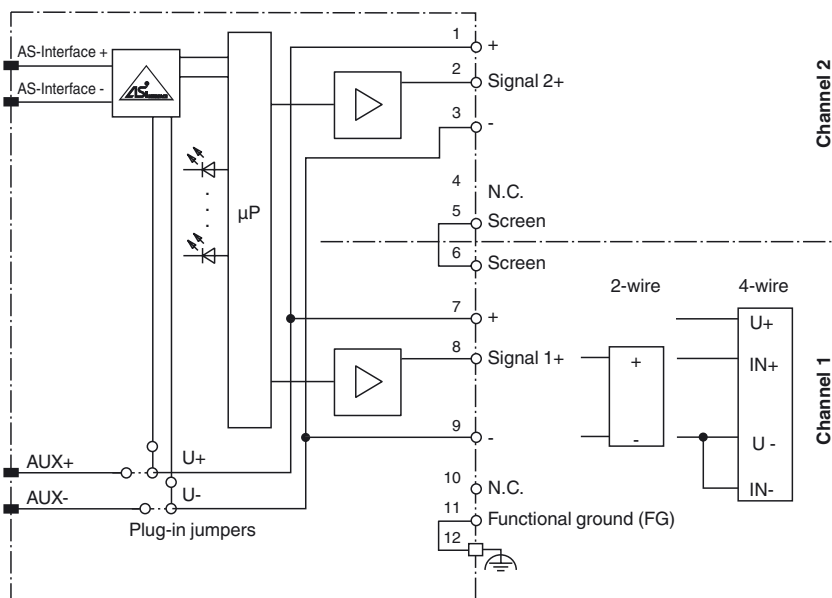

Indicating / Operating means

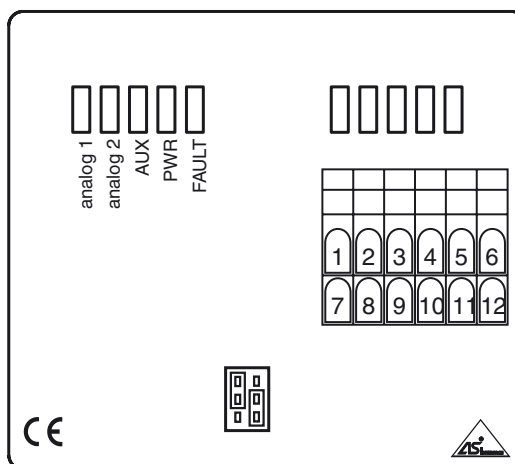

Spring terminal block:

- | | |
|----------------|----------------|
| 1: 24V ext. | 7: 24V ext. |
| 2: Sig.+ Ch. 2 | 8: Sig.+ Ch. 1 |
| 3: 0 V ext. | 9: 0 V ext. |
| 4: N.C. | 10: N.C. |
| 5: Shield | 11: FG |
| 6: Shield | 12: FG |

Plug-in jumper:

- Power supply of outputs from the external auxiliary power
- Power supply of outputs from the module (AS-Interface)

Release date: 2018-01-29 14:37 Date of issue: 2018-01-29 112480_eng.xml

Technical data**General specifications**

Slave type	Standard slave
AS-Interface specification	V2.1
Required master specification	≥ V2.1
UL File Number	E223772

Functional safety related parameters

MTTF _d	145 a at 30 °C
-------------------	----------------

Indicators/operating means

LED FAULT	error display; LED red red: communication error red flashing: peripheral error
LED PWR	AS-Interface voltage; LED green
LED ANALOG	status output signal; LED green green: $0\text{ V} \leq U \leq 11.5\text{ V}$ green flashing: $U > 11.5\text{ V}$ (peripheral error)
LED AUX	ext. auxiliary voltage U_{AUX} ; LED green

Electrical specifications

Auxiliary voltage (output)	U_{AUX}	24 V DC ± 15 % PELV
Rated operating voltage	U_e	26.5 ... 31.6 V from AS-Interface
Rated operating current	I_e	≤ 80 mA
Protection class		III

Output

Number/Type	2 analog outputs (voltage), 0 ... 10 V
Supply	from AS-Interface or from external auxiliary voltage as required U_{AUX}
Resolution	13 Bit / 1 mV

Directive conformity

Electromagnetic compatibility	
Directive 2014/30/EU	EN 62026-2:2013

Standard conformity

Degree of protection	EN 60529:2000
AS-Interface	EN 62026-2:2013

Programming instructions

Profile	S-7.3.5
IO code	7
ID code	3
ID2 code	5
Data bits (function via AS-Interface)	The transfer of the data value is based on AS-Interface Profile 7.3.

Parameter bits (programmable via AS-i) function

P0	not used
P1	projecting of the 2nd channel P1=1, channel 2 is projected P1=0, channel 2 is not projected
P2	Message of peripheral error P2=1, peripheral error is reported P2=0, peripheral error is not reported
P3	not used

Ambient conditions

Ambient temperature	0 ... 70 °C (32 ... 158 °F)
Storage temperature	-25 ... 85 °C (-13 ... 185 °F)

Mechanical specifications

Degree of protection	IP65
Connection	cable piercing method or terminal compartment yellow flat cable/black flat cable or standard round cable inputs/outputs: 2 x M16 x 1.5 cable glands and cage tension spring terminals, 1 x M12 x 1.5 cable gland (not used)
Material	
Housing	PA 6 GF30
Mass	350 g
Mounting	DIN mounting rail

Notes

Do not connect inputs and outputs, which are supplied via the module from AS-interface or via auxiliary power, with power supply and signal circuits with external potentials.

Function

The VBA-2A-G4-U analogue module has two voltage outputs 0 V... 10 V. The asynchronous transformation of measured values and the data transfer is accomplished in accordance with AS-Interface profile 7.3. The measured-value transmitter can be supplied from the AS-Interface or from the external auxiliary power via the black flat cable, depending on the wiring of the plug-in jumpers. The resolution of the analogue values is 13 bit.

The IP65 rated G4 module is especially suitable for rough conditions. Connection to the outputs is established by means of cable glands and cage tension spring terminals thus making the installation especially user-friendly. For pre-addressing the module it can be plugged directly onto the adapter of the hand-held programming device VBP-HH1.

Both flat and round cables can be used for the connection of the AS-Interface transmission line and the external 24 V DC power supply. Use the U-G1FF base for the AS-Interface flat cable. The AS-Interface standardised EEMS interface, uses the cable piercing method to connect both the yellow and black flat cables.

Use the U-G1PP base for a round cable. The AS-Interface cable as well as the external power supply may be connected within the U-G1PP base.

Accessories**VBP-HH1-V3.0-KIT**

AS-Interface Handheld with accessory

VBP-HH1-V3.0

AS-Interface Handheld

VAZ-G4-B

Blind plug PG7

VAZ-G4-B1

Blind plug M12

Matching system components**U-G1FF**

AS-Interface module mounting base for connection to flat cable (AS-Interface and external auxiliary power)

U-G1FFA

AS-Interface module mounting base with addressing jack for connection to flat cable (AS-Interface and external auxiliary power)

U-G1PP

AS-Interface module mounting base for connection to round cable (AS-Interface and external auxiliary power)