

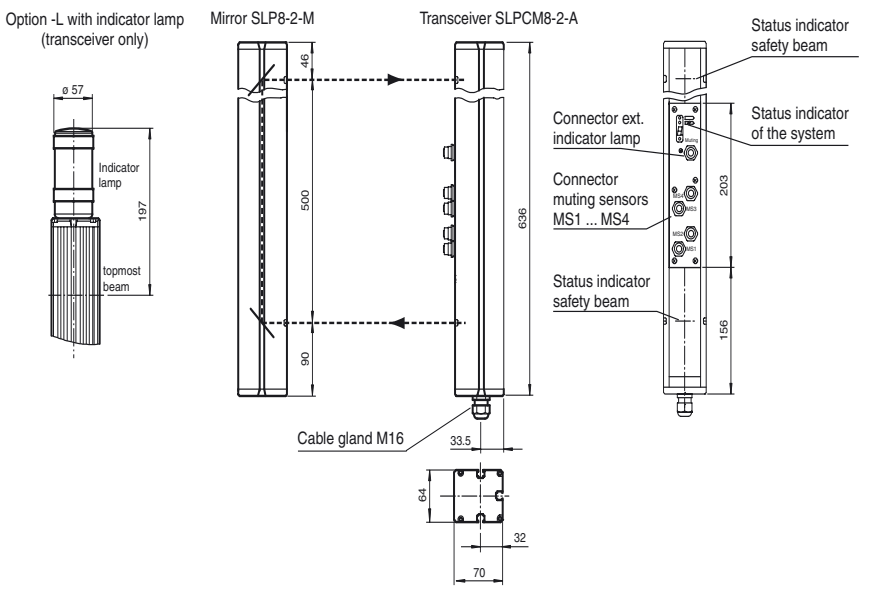

Dimensions



Model Number

SLPCM8-2

with 2 separate fail-safe semiconductor outputs

Features

- Sensing range up to 8 m
- 2-radial design
- Beam spacing 500 mm
- Self-monitoring (type 4 according to IEC/EN 61496-1)
- Minimum wiring expense due to transceiver with passive mirror column
- Red transmission light
- Usable with or without start/restart disable
- Sequential and parallel muting in various operating modes
- Emergency muting for the correction of the material jam
- Integrated relay monitor
- 7-segment diagnostic display
- Pre-fault indication
- OSSD outputs as semiconductor or relay outputs

Accessories

PG SLP-2

Protective glass panes for SLP series

Electrical connection

Transceiver SLPCM8-2-A

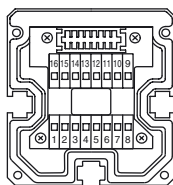

Transceiver SLPCM... (semiconductor output)	Transceiver SLPCM.../31 (Relay output)
4 - n.c.	1 - Functional earth
5 - -	2 - 0 V
6 - +	3 - 24 V
7 - OSSD 1	4 -
8 - OSSD 2	5 -
	6 -
	7 -
	8 -
	9 - Input, Relay monitor
	10 - Input, Start release
	11 - Input, Reset
	12 - PNP-output, Soiled optics
	13 - PNP-output, Muting lamp
	14 - PNP-output, Startup readiness
	15 - PNP-output, Muting OSSD AUS
	16 - PNP-output, Indicator OSSD ON

Release date: 2018-01-03 09:00 Date of issue: 2018-01-03 11:48:73_eng.xml

Technical data**System components**

Transceiver	SLPCM8-2-A
Mirror pillar	SLP8-2-M

General specifications

Effective detection range	0.2 ... 8 m
Light source	LED
Light type	modulated visible red light
Tests	IEC/EN 61496
Safety type according to IEC/EN 61496	4
Marking	CE
Target size	static: 32 mm dynamic: 50 mm (at v = 1.6 m/s of the obstacle)
Beam spacing	500 mm
Number of beams	2
Operating mode	Start/restart disable, relay monitor, muting operating modes
Angle of divergence	< 5 °

Functional safety related parameters

Performance level (PL)	PL e
Category	Cat. 4
Mission Time (T _M)	20 a
PFH _d	3.54 E-9
Type	4

Indicators/operating means

Diagnostics indicator	7-segment display
Function indicator	LED red: per receiver channel off: interruption flashes: receiver continuously on: reception with sufficient stability control on the front plate: LED red: OSSD off LED green: OSSD on LED yellow: types of muting operation
Pre-fault indicator	LED red next to receiver flashes
Control elements	10 DIP switch in transceiver terminal compartment

Electrical specifications

Operating voltage	U _B	24 V DC -15% / +25% , galvanically isolated
No-load supply current	I ₀	max. 250 mA
Protection class		III , IEC 61140

Input

Activation current	approx. 10 mA
Activation time	0.03 ... 1 s
Test input	Reset-input for system test
Function input	Relay monitor, start release, muting sensors (max. 4)

Output

Pre-fault indication output	1 PNP, +U _B -2 V, max. 300 mA
Safety output	2 separated fail safe semiconductor outputs
Signal output	1 PNP each, max. 300 mA for start readiness, OSSD on, OSSD off, muting lamp
Switching voltage	Operating voltage -2 V
Switching current	max. 0.5 A
Response time	20 ms

Conformity

Functional safety	ISO 13849-1
Product standard	EN 61496-1 ; IEC 61496-2

Ambient conditions

Ambient temperature	0 ... 50 °C (32 ... 122 °F)
Storage temperature	-20 ... 70 °C (-4 ... 158 °F)
Relative humidity	max. 95 % , not condensing

Mechanical specifications

Degree of protection	IP65
Connection	M16 cable gland , terminal compartment with cage-terminals, M12-connector for emitter, muting lamp as well as other muting sensors
Connection options	Further electrical connection options on request: Connector DIN 43 651 Hirschmann, emitter: 6-pin+PE, receiver: 11-pin+PE
Material	
Housing	extruded aluminum profile, RAL 1021 (yellow) coated
Optical face	Plastic pane
Mass	Per 2300 g

Approvals and certificates

CE conformity	CE
CCC approval	CCC approval / marking not required for products rated ≤36 V
Approvals	TÜV

Curves/Diagrams

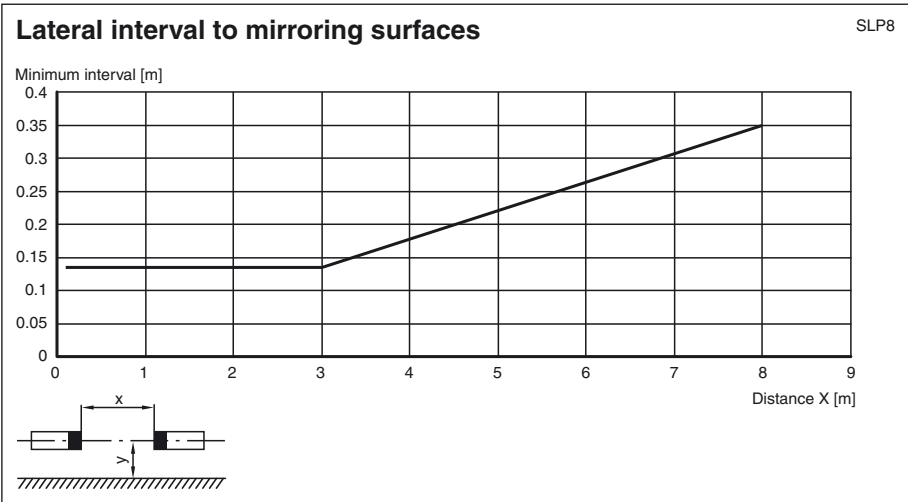
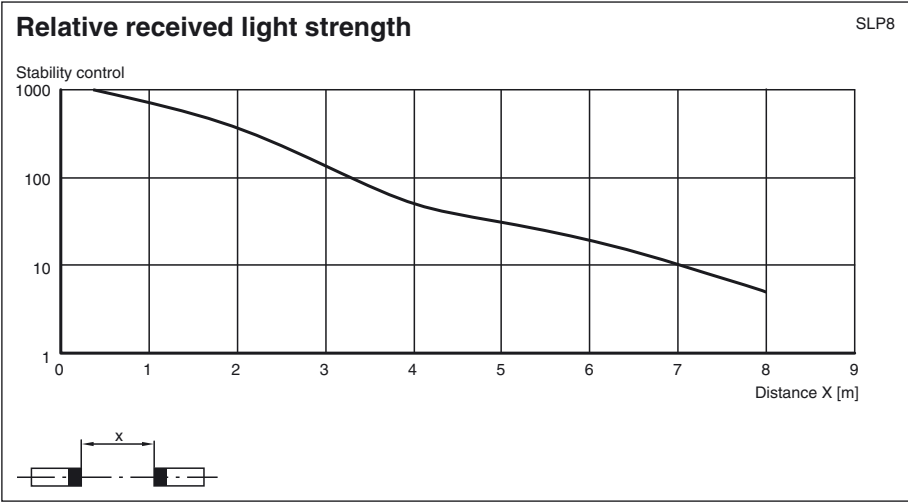
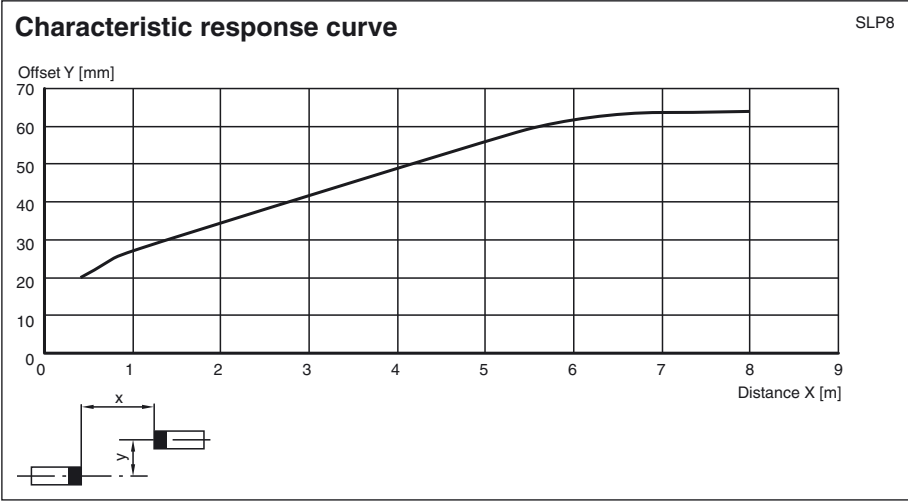



Release date: 2018-01-03 09:00 Date of issue: 2018-01-03 11:48:73_eng.xml

Refer to "General Notes Relating to Pepperl+Fuchs Product Information".

Additional information

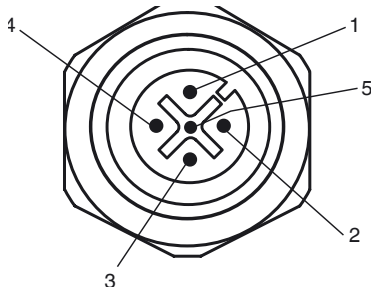
Socket assignment on the front side of the device



Indicator lamp control 

Socket	Function
1	OSSD on
2	OSSD off
3	0 V
4	Readiness for startup
5	Muting (monitored)

Muting sensor inputs MS1 - MS4

Socket	Function
1	+ 24 V
3	0 V
4	Sensor signal

System accessories

- Mounting set MS SLP
- Profile alignment aid PA SLP/SPC
- Laser alignment aid BA SLP
- Ground pillar UC SLP/SLC
- Housing for pillar Enclosure UC SLP/SLC
- Collision protector Damping UC SLP/SLC
- Redirection mirror SLP-2-M

Release date: 2018-01-03 09:00 Date of issue: 2018-01-03 11:48:73_eng.xml