



Model Number

MLV12-54-2563/49/124

Fire protection retroreflective sensor with 4-pin or 5-pin M12 connector, 90° adjustable position

Features

- Small fire protection photoelectric sensor for safety devices on fire barriers
- Approval in accordance with VdS Test Report FSA and externally monitored manufacture (Ü Symbol)
- High protection against contact
- Not sensitive to ambient light, even with switched energy saving lamps

Product information

It is essential that fire is not allowed to spread in buildings should it break out. Fire protection regulations therefore prescribe fire barriers. These include fire doors, industrial fire doors and fire dampers, which are generally kept closed at all times. In areas where doors are left open, such as heavily traveled passageways and corridors, a self-closing mechanism must be automatically triggered in case of fire. However, the door must not close when persons or objects are in the closing area. Legislation consequently requires monitoring with appropriate safety devices. The technical challenge is to ignore the smoke and at the same time reliably detect objects in it. These certified photoelectric sensors fulfill this function.

Release date: 2018-09-20 09:33 Date of issue: 2018-10-17 11:18:47_eng.xml

Dimensions

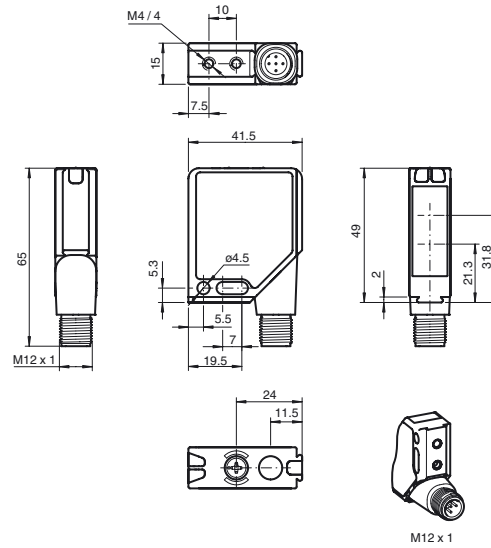

Electrical connection

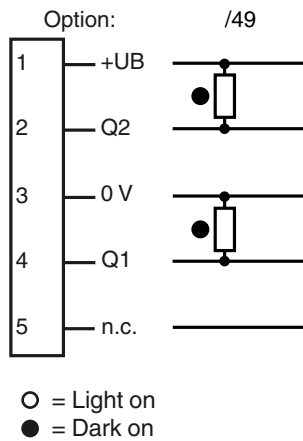

Pinout

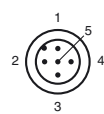

Wire colors in accordance with EN 60947-5-2

1	BN	(brown)
2	WH	(white)
3	BU	(blue)
4	BK	(black)
5	GY	(gray)

Indicators/operating means

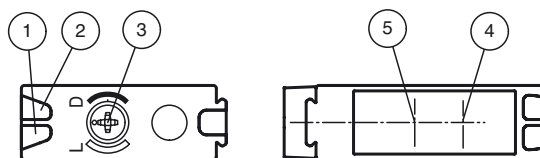

1	Operating display	green
2	Switch state	yellow
3	Light/dark switch	
4	Optical axis emitter	
5	Optical axis receiver	

Technical data

General specifications

Effective detection range	0 ... 2.1 m (with H60 reflector)
Reflector distance	0.2 ... 2.1 m
Reference target	H60 reflector
Light source	LED 645 nm
Light type	modulated visible red light
Diameter of the light spot	approx. 70 mm
Angle of divergence	1.5 °
Ambient light limit	50000 Lux

Indicators/operating means

Operation indicator	LED green, flashes in case of short-circuit
Function indicator	2 LEDs yellow, light up when light beam is free, flash when falling short of the stability control, off when light beam is interrupted
Control elements	rotary switch for light/dark

Electrical specifications

Operating voltage	U_B	10 ... 30 V DC
Ripple		max. 10 %
No-load supply current	I_0	max. 40 mA
Protection class		II, rated voltage \leq 300 V AC with pollution degree 1-2 according to IEC 60664-1

Output

Switching type	light/dark on switchable	
Signal output	1 NPN and 1 PNP output, direct switching, short-circuit protected, reverse polarity protected, open collector	
Switching voltage	max. 30 V DC	
Switching current	max. 0.2 A	
Voltage drop	U_d	\leq 2.5 V DC
Switching frequency	f	\leq 40 Hz
Response time		10 ms

Standard conformity

Standards	EN 60947-5-2 smoke insensitive up to 2 dB/m (EN 54-12)
-----------	---

Ambient conditions

Ambient temperature	-40 ... 60 °C (-40 ... 140 °F)
Storage temperature	-40 ... 75 °C (-40 ... 167 °F)
Relative humidity	30% ... 85% non-condensing ; Non-icing

Mechanical specifications

Degree of protection	IP67
Connection	5-pin M12 x 1 connector with metal thread, 90° rotatable
Material	
Housing	Frame: nickel plated, die cast zinc, Laterals: glass-fiber reinforced plastic PC
Optical face	Plastic pane
Mass	60 g

Approvals and certificates

UL approval	cULus Listed, Class 2 Power Source, Type 1 enclosure
CCC approval	CCC approval / marking not required for products rated \leq 36 V
Approvals	VdS/DIBt certificate of compliance No. 25020

Curves/Diagrams

Characteristic response curve

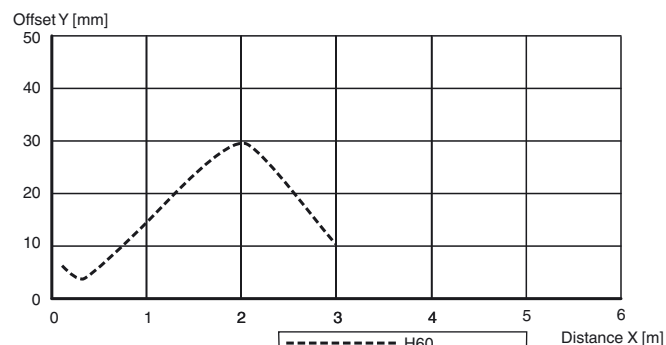

Typical applications

- Securing hold-open devices on fire barriers in the vicinity of track-based conveyor systems
- Reliable object detection for doorway monitoring with fire barriers in the vicinity of track-based conveyor systems, even in smoky conditions

Detection area



Accessories

REF-H60-2

Reflector with mounting holes

OMH-MLV12-HWG

Mounting bracket for series MLV12 sensors

OMH-MLV12-HWK

Mounting bracket for series MLV12 sensors

OMH-06

Mounting aid for round steel \varnothing 12 mm or sheet 1.5 mm ... 3 mm

OMH-K01

dove tail mounting clamp

OMH-K02

dove tail mounting clamp

OMH-K03

dove tail mounting clamp

V15-G-2M-PUR

Female cordset, M12, 5-pin, PUR cable

V15-G-PG9

Female connector, M12, 5-pin, field attachable

V1-G-BK10M-PUR-U

Female cordset, M12, 4-pin, PUR cable

Other suitable accessories can be found at www.pepperl-fuchs.com

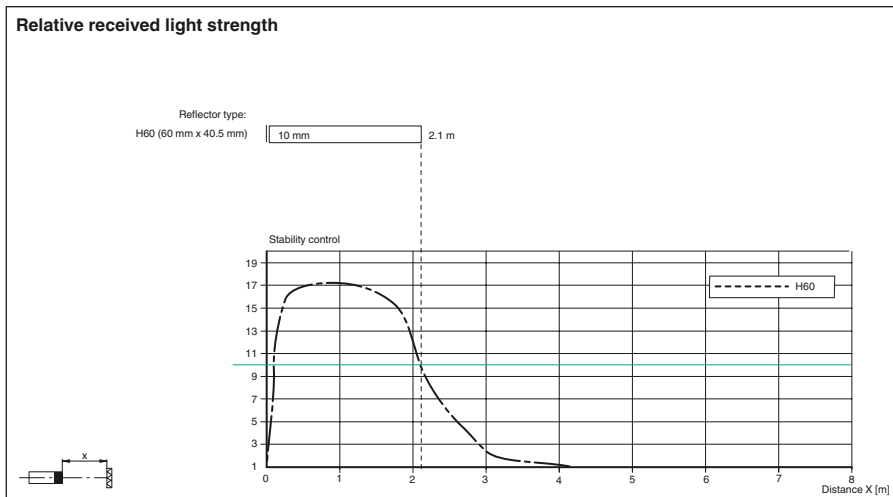

Functional principle

The MLV12-54-2563 is a diffuse-mode photoelectric sensor with polarization filter. The diffuse-mode photoelectric sensor is an emitter and a receiver in a single housing. The emitted light is reflected back to the receiver by a reflector. When the light beam is interrupted, the switching function is triggered.

Characteristics

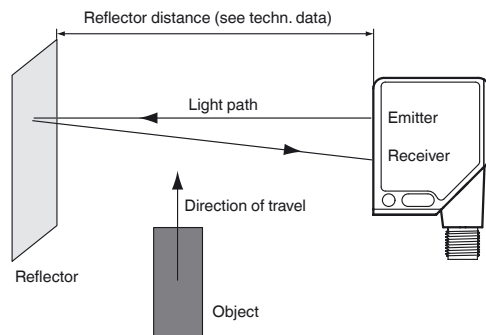

Marking

Due to its high excess gain, the MLV12-54-2563 diffuse-mode photoelectric sensor is suitable as a safety device for hold-open devices on fire barriers. The safety functionality has been tested by VdS (German Association of Property Insurers) (Test Report FSA 07009). The MLV12-54-2563 diffuse-mode photoelectric sensor detects objects and is also insensitive to defined smoke levels (test fires 2 to 5). The MLV12-54-2563 diffuse-mode photoelectric sensor is used as a safety device with a range of 0.2 m to 2.1 m onto the H60 reflector.