

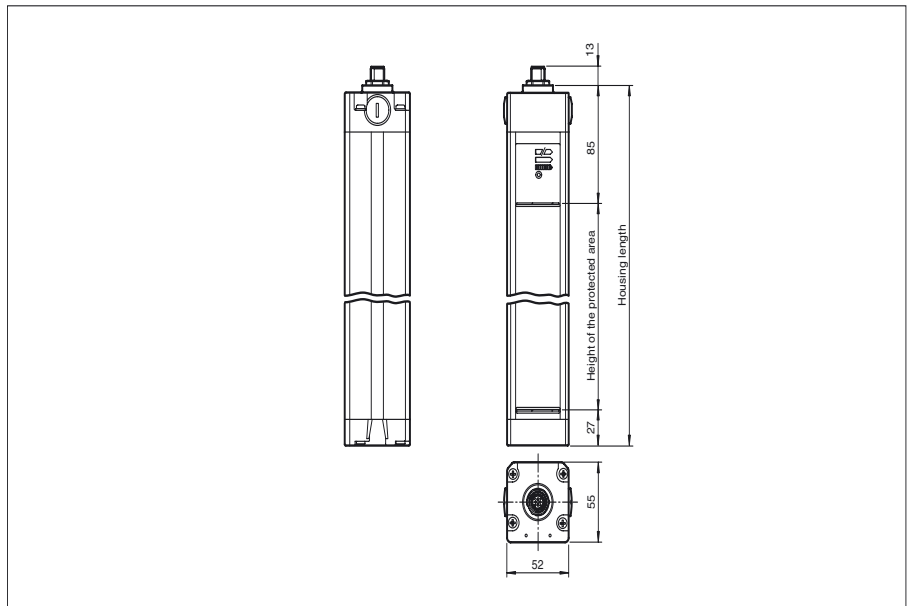

Dimensions



Model Number

SLC14-450/129

with 2 separate fail-safe semiconductor outputs

Features

- Sensing range up to 5 m
- Resolution 14 mm (finger protection)
- Self-monitoring (type 4 according to IEC/EN 61496-1)
- Master/Slave detection, Plug and Play
- Degree of protection IP67
- Integrated function display
- Pre-fault indication
- Safety outputs OSSD in potential-separated semiconductor version
- Protective field height up to 1800 mm
- Start/Restart disable preset by Option /129
- Integrated relay monitor

Accessories

PG SLC-450
Protective glass panes for SLC series

BA SLC
laser alignment aid for safety light curtains series SLC

Electrical connection

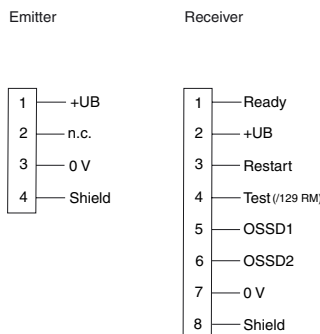

Pinout

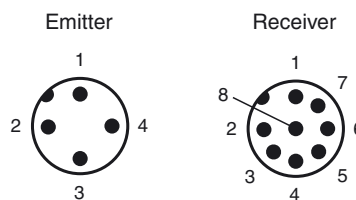

Release date: 2017-12-07 14:18 Date of issue: 2017-12-07 192920_eng.xml

Technical data**System components**

Emitter	SLC14-450-T
Receiver	SLC14-450-R/129

General specifications

Effective detection range	0.2 ... 5 m
Light source	IRED
Light type	modulated infrared light
LED risk group labelling	exempt group
Tests	IEC/EN 61496
Safety type according to IEC/EN 61496	4
Width of protected area	0.2 ... 5 m
Protection field height	450 mm
Number of beams	48
Operating mode	Startup/restart disable preset with Relay monitor (preset)
Optical resolution	14 mm
Angle of divergence	< 5 °

Functional safety related parameters

Safety Integrity Level (SIL)	SIL 3
Performance level (PL)	PL e
Category	Cat. 4
Mission Time (T _M)	20 a
PFH _d	2.42 E-8
Type	4

Indicators/operating means

Operation indicator	7-segment display in emitter
Diagnostics indicator	7-segment display in receiver
Function indicator	in receiver: LED red: OSSD off LED green: OSSD on LED yellow: Protected area free, system start-ready
Pre-fault indicator	LED orange
Control elements	Transmission coding

Electrical specifications

Operating voltage	U _B	24 V DC (-30 %/+25 %)
No-load supply current	I ₀	Emitter: ≤ 100 mA receiver: ≤ 150 mA
Protection class		III

Input

Activation current	approx. 10 mA
Activation time	0.03 ... 1 s
Function input	Start release

Output

Safety output	2 separated fail safe semiconductor outputs
Signal output	1 PNP, max. 100 mA for start readiness
Switching voltage	Operating voltage -2 V
Switching current	max. 0.5 A
Response time	18 ms

Conformity

Functional safety	ISO 13849-1
Product standard	EN 61496-1 ; IEC 61496-2

Ambient conditions

Ambient temperature	0 ... 55 °C (32 ... 131 °F)
Storage temperature	-25 ... 70 °C (-13 ... 158 °F)
Relative humidity	max. 95 %, not condensing

Mechanical specifications

Housing length L	560 mm
Degree of protection	IP67
Connection	Emitter: terminal compartment with screw terminals, lead cross-section max. 1.5 mm ² Receiver: terminal compartment with screw terminals, lead cross-section max. 1.5 mm ²
Material	
Housing	extruded aluminum profile, RAL 1021 (yellow) coated
Optical face	Plastic pane
Mass	Per 1650 g

Approvals and certificates

CE conformity	CE
UL approval	cULus Listed
CCC approval	CCC approval / marking not required for products rated ≤36 V
TÜV approval	TÜV

Curves/Diagrams

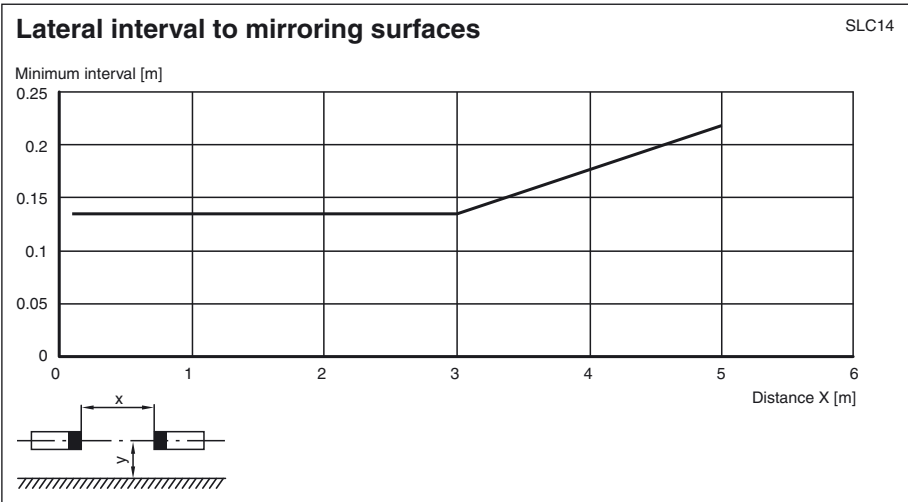
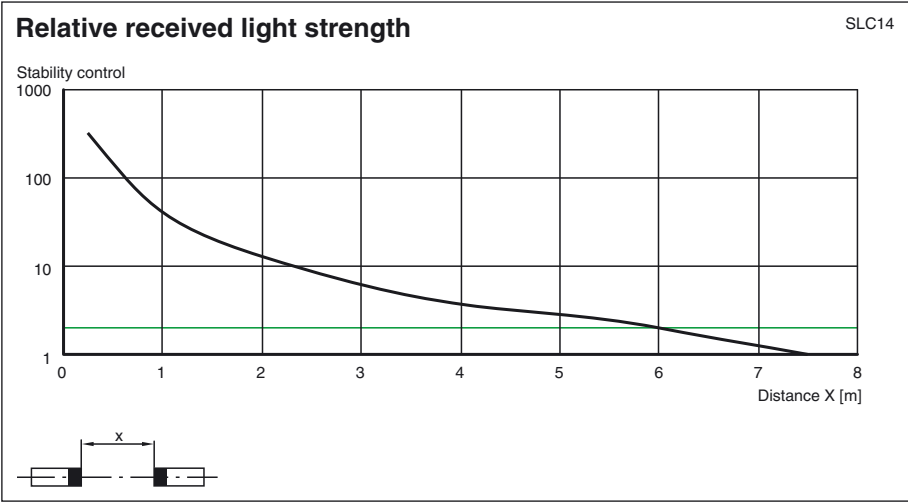
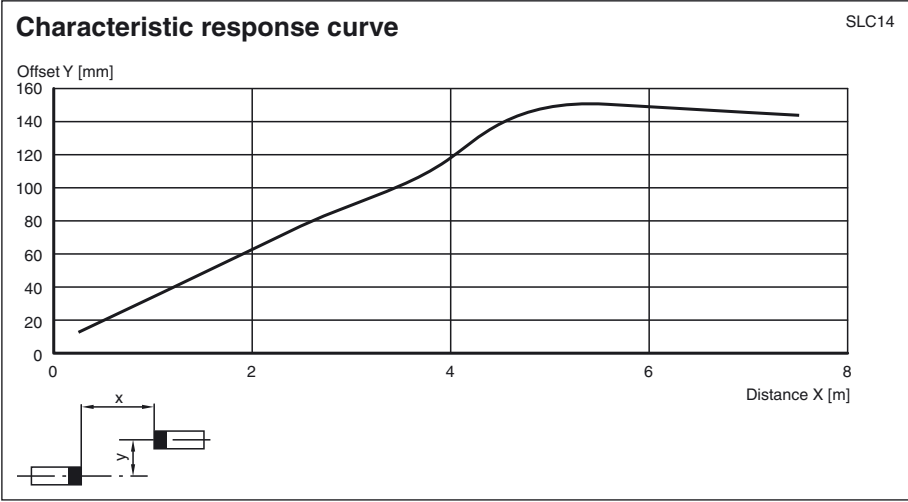

Release date: 2017-12-07 14:18 Date of issue: 2017-12-07 192920_eng.xml

Notes

Master slave mode

Master: SLC...-... (semiconductor)
or
SLC...-.../31 (relay)
Slave: SLC...-...-S

Using slaves makes it possible to lengthen protective fields or to form protective fields that lie in more than just one level. When you select slaves that can be connected, you should take into consideration that the maximum number of 96 light rays must not be exceeded.

There are slaves for transmitters and receivers. These may simply be connected to the master light curtain. As many as 2 slaves may be connected respectively to the transmitter and receiver unit.

Installation:

- 1 The end cap should be screwed off for the light curtain (without cable gland).
- 2 The plug-in jumper on the connectors of the printed circuit board, which is now visible, should be removed.
- 3 The slave is designed so that the cap located on the cable connector can be plugged directly onto the open end of the light curtain with the printed circuit board.
- 4 After you have screwed on the connection cap, the system is complete.

System accessories

- Mounting set SLC
- Test rods SLC14/SLC30/SLC60
- Protective glass pieces for SLC (to protect the optically functional surface)
- Lateral screwed connection SLC
- Profile alignment aid
- Laser alignment aid SLC
- Mirror for SLC (for securing hazardous areas on multiple sides)
- Ground pillar UC SLP/SLC
- Housing for pillar
Enclosure UC SLP/SLC
- Collision protector
Damping UC SLP/SLC