



Model number

WCS2B-LS266

Read head, RS 485 interface, with RS 485 termination resistor

Features

- RS 485 interface
- Non-contact, absolute position encoder
- Automatic detection of dirt accumulation

Accessories

WCS-MP1

Mounting plate for reading heads WCS2 and WCS3

WCS2-PL2

Transparent protective case and seal for WCS2 reader

Note

with RS 485 interface

Dimensions

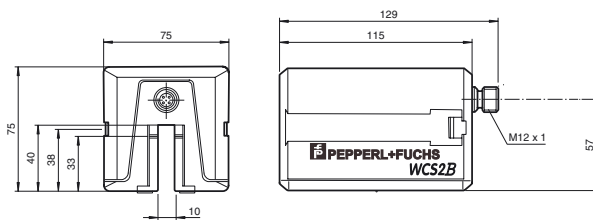

Mounting plate

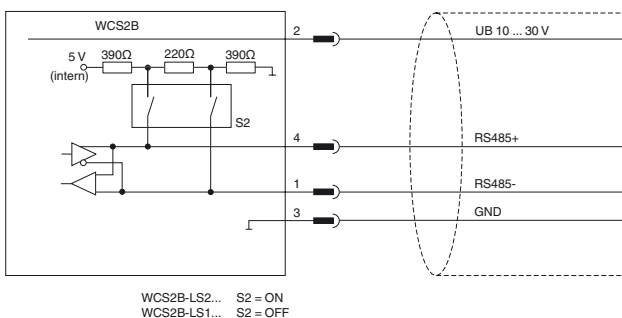
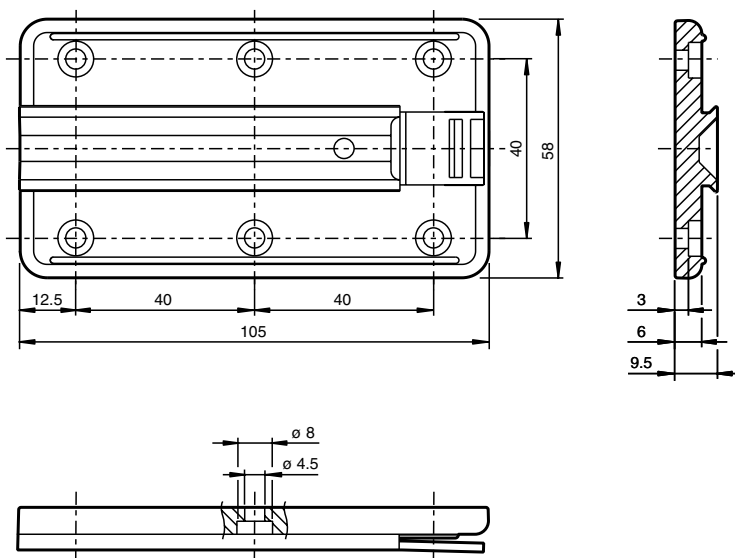

Technical data

General specifications

Passage speed	v	≤ 12.5 m/s
Measuring range		max. 327 m
Free tolerances to code rail		horizontal: 10 mm (± 5 mm) vertical: 10 mm (± 5 mm)
Resolution		± 0.42 mm (1,200 positions/m)

Functional safety related parameters

MTTF _d	60 a
Mission Time (T _M)	10 a
Diagnostic Coverage (DC)	0 %

Electrical specifications

Operating voltage	U _B	10 ... 30 V DC
-------------------	----------------	----------------

Release date: 2013-06-12 14:39 Date of issue: 2013-06-12 200779-0013_eng.xml

Power consumption	P_0	2 VA
Interface		
Interface type	RS 485 interface	
Data output code	binary code	
Protocol	3 , with Parity (9 Bit/Byte)	
Transfer rate	38.4 kBit/s	
Termination	with RS 485 termination	
Standard conformity		
Emitted interference	DIN EN 61000-6-4	
Noise immunity	DIN EN 61000-6-2	
Shock resistance	DIN EN 60068-2-27, half sine 30 g, 18 ms	
Vibration resistance	DIN EN 60068-2-6, sine, 5 g, 10 - 2000 Hz, 10 cycles	
Ambient conditions		
Operating temperature	0 ... 60 °C (32 ... 140 °F)	
Storage temperature	-40 ... 85 °C (-40 ... 185 °F)	
Relative humidity	90 % , noncondensing	
Mechanical specifications		
Connection type	M12 x 1 connector, 5-pin	
Protection degree	IP54	
Material		
Housing	ABS , Polycarbonate , Polyamide (PA)	
Mass	500 g	
General information		
Ordering information	Mounting plate included with delivery	