



Model number

INX360D-F99-B20-V15

Features

- E1-Type approval
- Measuring range 0 ... 360°
- High shock resistance
- Extended temperature range -40 ... +85 °C
- CAN bus with SAE J1939 protocol

Electrical connection

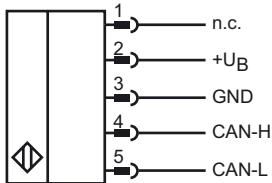

Technical Data

General specifications

Type	Inclination sensor, 1-axis
Measurement range	0 ... 360 °
Absolute accuracy	≤ ± 0.5 °
Response delay	≤ 20 ms
Resolution	≤ 0.1 °
Repeat accuracy	≤ ± 0.1 °
Temperature influence	≤ 0.027 °/K

Functional safety related parameters

MTTF _d	650 a
Mission Time (T _M)	20 a
Diagnostic Coverage (DC)	0 %

Indicators/operating means

Operation indicator	LED, green
Status indicator	LED, yellow
Error indicator	LED, red

Electrical specifications

Operating voltage U _B	5 ... 30 V DC
No-load supply current I ₀	≤ 100 mA
Power consumption P ₀	≤ 0.7 W

Interface

Interface type	J1939
Data output code	binary code
Transfer rate	10 ... 1000 kBit/s , programmable
Node ID	0 ... 253 , programmable
Termination	external
Cycle time	programmable
SLOT Range	0 ... 359.99 °
SLOT Offset	0 °

Ambient conditions

Ambient temperature	-40 ... 85 °C (-40 ... 185 °F)
Storage temperature	-40 ... 85 °C (-40 ... 185 °F)

Mechanical specifications

Connection type	5-pin, M12 x 1 connector 5-pin, M12 x 1 socket internal bridged
Housing material	PA
Degree of protection	IP68 / IP69K
Mass	240 g

Factory settings

Node ID	128
Transfer rate	250 kBit/s

Compliance with standards and directives

Standard conformity	
Shock and impact resistance	100 g according to DIN EN 60068-2-27
Standards	EN 60947-5-2:2007 IEC 60947-5-2:2007

Approvals and certificates

UL approval	cULus Listed, Class 2 Power Source
CSA approval	cCSAus Listed, General Purpose, Class 2 Power Source
E1 Type approval	10R-04

Dimensions

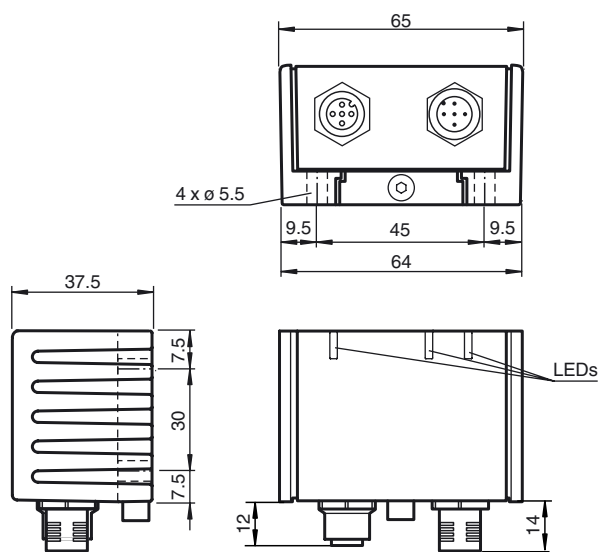

Sensor Orientation

In the default setting the zero position of the sensor is reached, when the electrical connection faces straight downwards.

X Orientation

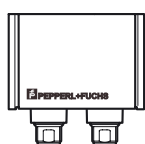
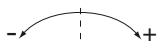

X = 0°

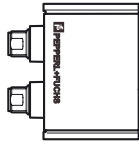

X = 90°

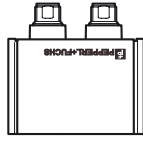

X = ±180°

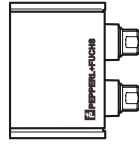

X = 270° (-90°)

Mounting of the sensor

Sensors from the -F99 series consist of a sensor module and accompanying cast aluminum housing. Select a vertical surface with minimum dimensions of 70 mm x 50 mm to mount the sensor. Mount the sensor as follows:

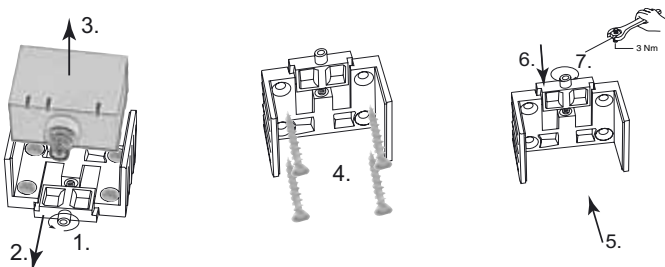

1. Loosen the central screw under the sensor connection.
 2. Slide back the clamping element until you are able to remove the sensor module from the housing.
 3. Remove the sensor module from the housing.
 4. Position the housing at the required mounting location and secure using four countersunk screws. Make sure that the heads of the screws do not protrude.
 5. Place the sensor module in the housing.
 6. Slide the clamping element flush into the housing. Check that the sensor element is seated correctly.
 7. Finally tighten the central screw.
- The sensor is now mounted correctly.

EMC Properties

Pinout

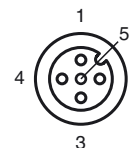
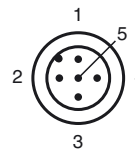

Wire colors in accordance with EN 60947-5-2

1	BN	(brown)
2	WH	(white)
3	BU	(blue)
4	BK	(black)
5	GY	(gray)

Accessories

V15-G-2M-PUR-CAN-V15-G

DeviceNet/CANOpen bus cable, M12 to M12, PUR cable 5-pin

V15-G-5M-PUR-CAN-V15-G

DeviceNet/CANOpen bus cable, M12 to M12, PUR cable 5-pin

V15-G-10M-PUR-CAN-V15-G

DeviceNet/CANOpen bus cable, M12 to M12, PUR cable 5-pin

V15S-T-CAN/DN-V15

Y distributor, M12 socket on M12 connector/socket

ICZ-TR-CAN/DN-V15

Terminal resistor for DeviceNet, CANOpen

Release date: 2018-09-25 11:11 Date of edition: 2018-09-25 241681_eng.xml

Interference immunity in accordance with
 DIN ISO 11452-2: 100 V/m
 Frequency band 20 MHz up to 280 MHz and 295 MHz up to 2 GHz
 Mains-borne interference in accordance with ISO 7637-2:

Pulse	1	2a	2b	3a	3b	4	5
Severity level	III	III	III	III	III	III	IV
Failure criterion	C	A	C	A	A	C	A

EN 61000-4-2: CD: 8 kV / AD: 15 kV

Severity level IV

EN 61000-4-3: 30 V/m (80...2500 MHz)

Severity level IV

EN 61000-4-4: 2 kV

Severity level III

EN 61000-4-6: 10 V (0.01...80 MHz)

Severity level III

EN 55011: Klasse A