

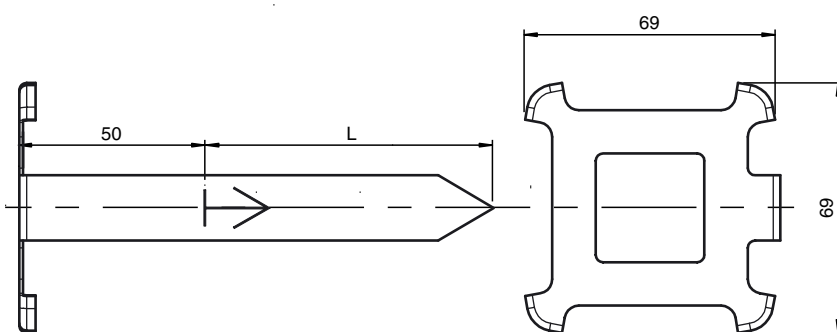

Dimensions



Model Number

PCV-AG80

Alignment guide for PCV80-* read head

Technical data

General specifications

Description Alignment guide for the PCV80-* read head Distance: 80†mm

Mechanical specifications

Material Metal sheet (steel), zinc-plated

Mass 39 g

Dimensions L = 80 mm

Release date: 2012-03-19 13:32 Date of issue: 2012-04-23 244214_eng.xml