



Model Number

OMH-SLCT-120-2100

Side protection for mounting base

Features

- Side protection for the OMH-SLCT-100 and OMH-SLCT-110 mounting bases

Accessories

OMH-SLCT-100-2100

Mounting base for floor mounting and cover plate

OMH-SLCT-110-2100

Mounting base for floor mounting with rear panel and cover plate

Dimensions

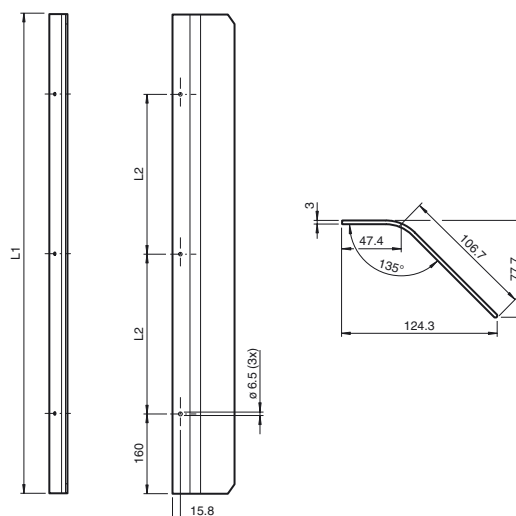

Technical data

Ambient conditions

Ambient temperature	-40 ... 80 °C (-40 ... 176 °F)
Storage temperature	-40 ... 80 °C (-40 ... 176 °F)
Relative humidity	80 % , noncondensing

Mechanical specifications

Housing length L	2040 mm
Material	
Housing	anodized aluminum
Mounting screw	Steel
Mass	approx. 4.9 kg
Mounting	Mounting accessories included

General information

Scope of delivery	2x lateral protection, mounting materials
-------------------	---

Mechanical arrangement

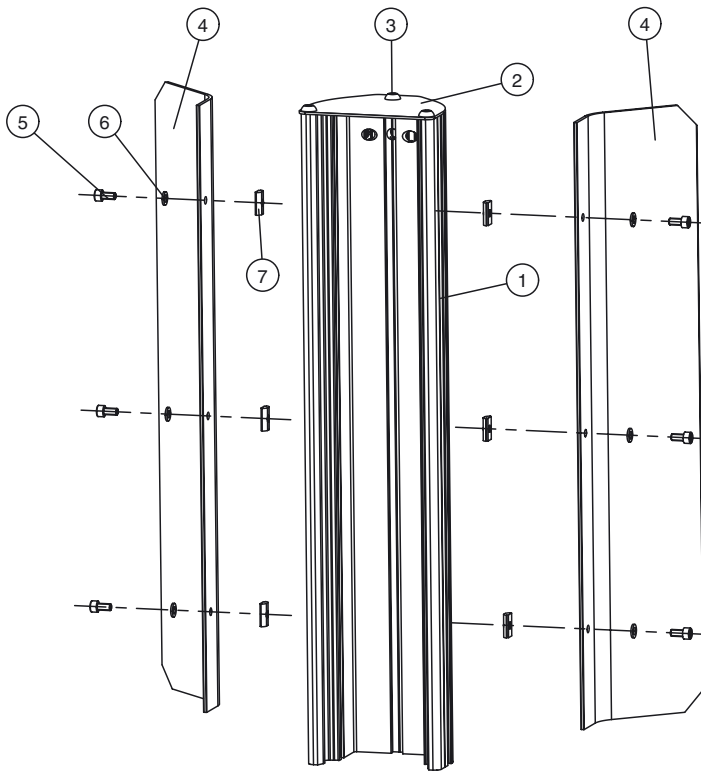

1	Mounting base	4	Lateral protection	7	Spring T-nut M6
2	Cover plate	5	Socket cap screw M6 x 12		
3	Rounded head screw M8 x 20	6	Washer		

Release date: 2017-10-04 09:56 Date of issue: 2017-10-04 251620_eng.xml