



Model Number

V15-W-BK10M-PUR-U

Female cordset, M12, 5-pin, PUR cable

Features

- UL Recognized Component
- Knurled nut suitable for tool assembly
- Immunity to vibration, with mechanical latching
- Degree of protection IP67 / IP68 / IP69K
- Flame resistant cable
- Halogen-free

Dimensions

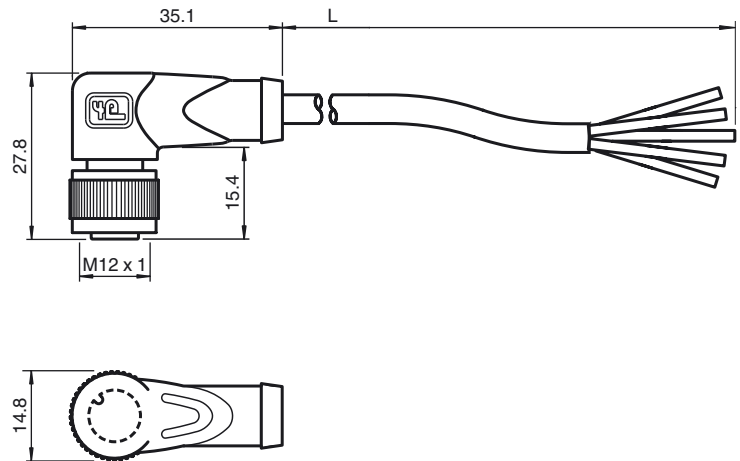

Technical data

General specifications

Number of pins	5
Connection 1	socket
Construction type 1	right angle
Threading 1	M12
Connection 2	cable end
UL File Number	E231213

Electrical specifications

Operating voltage	U_B	max. 60 V AC/DC
Operating current	I_B	max. 4 A
Volume resistance		< 5 m Ω

Ambient conditions

Ambient temperature	Body: -40 ... 90 °C (-40 ... 194 °F) cable, fixed: -40 ... 80 °C (-40 ... 176 °F) cable, flexing: -25 ... 80 °C (-13 ... 176 °F)
Pollution degree	3

Mechanical specifications

Contact elements	spring-loaded contact socket
Degree of protection	IP67 / IP68 / IP69k
Material	
Contacts	CuSn
Contact surface	Ni/Au
Body	TPU, black
Cable	PUR
Slotted nut	Zinc die-casting, nickel-plated
Core insulation	PP
Cable	extra-fine wire, flexible
Sheath diameter	Ø4.8 mm
Bending radius	> 10 x cable diameter, appropriate for conveyor chains > 5 x cable diameter, fixed
Color	dark grey (RAL 7021)
Cores	22 AWG
Number of cores	5
Core cross-section	0.34 mm ²
Conductor construction	42 x 0.1 mm Ø
Length	L 10 m
Flammability	
Contact carrier	HB
Housing	V-2
Cable	FT2

Compliance with standards and directives

Standard conformity	
Degree of protection	EN 60529:2000

Electrical connection

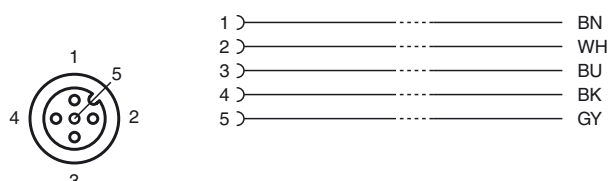

Standards	IEC 61076-2-101:2008
Flammability	Body: UL 94 Line: UL 1581 Section 1061; IEC 60332-1-2:2004
Halogen-free	IEC 60754-1:1994
Approvals and certificates	
UL approval	UL Recognized General purpose
Maximum permissible operating voltage	≤ 30 V
Maximum permissible ambient temperature	≤ 80 °C (≤ 176 °F)

Accessories

MH V1-SCREWDRIVER
torque screwdriver (0.6 Nm)

MH V1-BIT M12
plug-in cap M12

V1/V3-LABELHOLDER
Label holder

V1/V3-LABEL
Label plate

MH V1-Holder
Modular universal holder for M12 connectors

V1-MARKING-RING-BLUE
Marking ring for M12 plug

V1-MARKING-RING-GREEN
Marking ring for M12 plug

V1-MARKING-RING-ORANGE
Marking ring for M12 plug

V1-MARKING-RING-RED
Marking ring for M12 plug

V1-MARKING-RING-WHITE
Marking ring for M12 plug

V1-MARKING-RING-YELLOW
Marking ring for M12 plug