



Model Number

V1-8A-E2-5M-PUR

Octuple splitter box with M12 connector with trunk cable

Features

- LED indicator for module supply and I/O status
- UL Recognized Component
- Suitable for drag chains

Accessories

VAZ-V1-B3

Blind plug for M12 sockets

MH 05-SACB-8

Mounting aid for splitter boxes for DIN rail

MH V1-BIT M12

plug-in cap M12

MH V1-SCREWDRIVER

torque screwdriver (0.6 Nm)

Dimensions

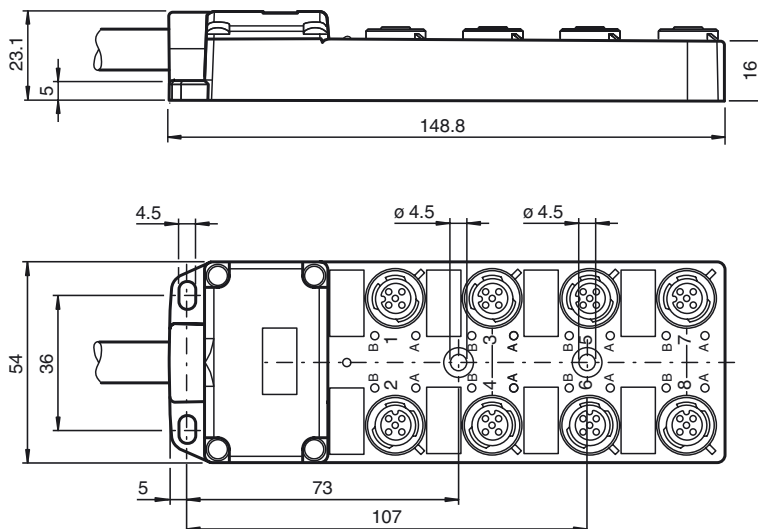

Technical data

General specifications

Number of pins	4
UL File Number	E191152

Electrical specifications

Operating voltage	U_B	24 V DC, max. 30 V DC
Operating current	I_B	≤ 5 mA per channel indication element
Current loading capacity		≤ 2 A per channel, ≤ 4 A per plug-in station, ≤ 12 A total current per separator

Output

Number/Type	8
-------------	---

Ambient conditions

Ambient temperature	housing: -25 ... 80 °C (-13 ... 176 °F) cable, flexing: -5 ... 80 °C (23 ... 176 °F) cable, fixed: -40 ... 90 °C (-40 ... 194 °F)
---------------------	---

Mechanical specifications

Connection type	8 x socket M12 x 1 4-pin Master cable
Degree of protection	IP65/IP67
Material	
Contacts	Cu alloy
Contact surface	Au
Housing	PBT
Threaded bushings	PBT
Cable	PUR
Seal	O-ring: NBR
Core insulation	PVC
Cable	flexible
Sheath diameter	Ø 8.5 mm
Bending radius	> 10 x cable diameter, moving > 7.5 x cable diameter, fixed
Color	black
Cores	Signalling line (4): 8 x 0.34 mm ² (AWG 22) Supply line (1, 3), PE (5): 3 x 0.75 mm ² (AWG 18)
Conductor construction	19 x 0.15 mm Ø and 42 x 0.15 mm Ø
Length	L 5 m
Drag chain suitability	
Drag chain cycles	≥ 1500000
Motion velocity	≤ 2 m/s
Traverse distance	2 m
Mass	approx. 770 g

Compliance with standards and directives

Release date: 2018-11-14 10:37 Date of issue: 2018-11-14 259977_eng.xml

Refer to "General Notes Relating to Pepperl+Fuchs Product Information".

Pepperl+Fuchs Group
www.pepperl-fuchs.com

USA: +1 330 486 0001
fa-info@us.pepperl-fuchs.com

Germany: +49 621 776 4411
fa-info@de.pepperl-fuchs.com

Singapore: +65 6779 9091
fa-info@sg.pepperl-fuchs.com

Standard conformity

Degree of protection EN 60529

Flammability DIN EN 50265-2-1

Electrical connection

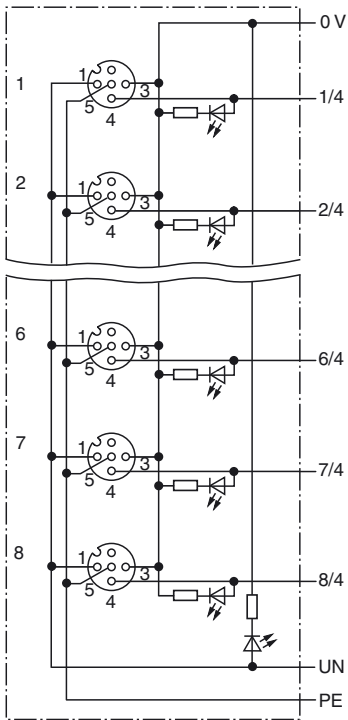

Slot/Pin (signal)	Color
1 / 4 (A)	WH
2 / 4 (A)	GN
3 / 4 (A)	YE
4 / 4 (A)	GY
5 / 4 (A)	PK
6 / 4 (A)	RD
7 / 4 (A)	BK
8 / 4 (A)	VT
1-8 / 1 (UN)	BN
1-8 / 3 (0 V)	BU
1-8 / 5 (PE)	GN/YE

