



Model Number

PHA200-F200-B17-V1D

Precision positioning on hole in the 70 mm x 70 mm housing

Features

- Detects the position of an index hole
- Large capture range
- High operating range
- Integrated contrast compensation
- Compact design
- PROFINET interface
- Integrated illumination

Function

The sensor has been developed for the precision positioning of high-bay racking operating equipment. It detects circular holes in the racking structure and their positional deviation from the nominal position. The sensor operates in two dimensions.

Indicating / Operating means

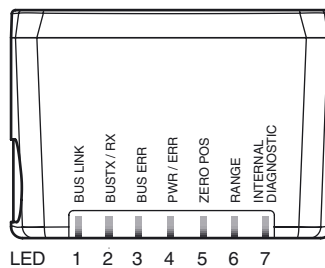
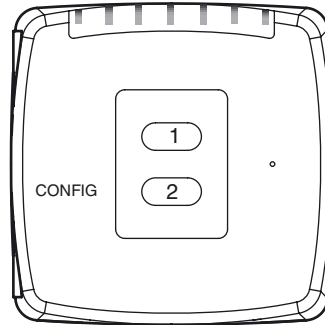

Electrical connection

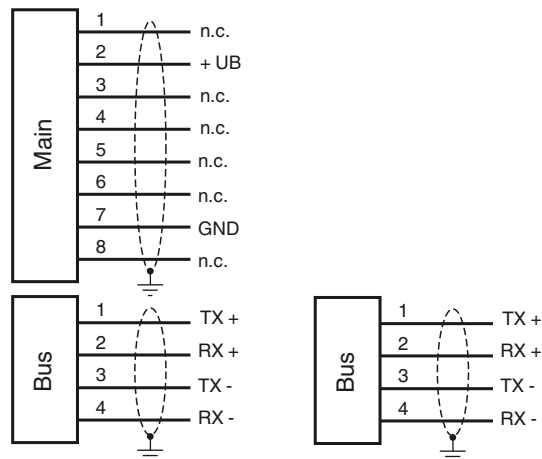

Pinout

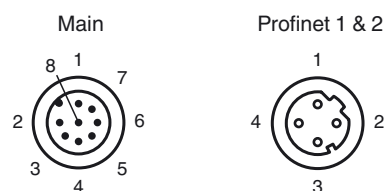

Technical data

Release date: 2018-10-17 16:40 Date of issue: 2018-10-22 266680_eng.xml

Refer to "General Notes Relating to Pepperl+Fuchs Product Information".

Pepperl+Fuchs Group
www.pepperl-fuchs.com

USA: +1 330 486 0001
fa-info@us.pepperl-fuchs.com

Germany: +49 621 776 4411
fa-info@de.pepperl-fuchs.com

Singapore: +65 6779 9091
fa-info@sg.pepperl-fuchs.com

General specifications

Light type	Integrated LED lightning (infrared)
Object size	Hole diameter 13 mm
Response delay	100 ms
Read distance	200 mm
Depth of focus	± 50 mm
Capture range	max. 120 mm x 100 mm

Nominal ratings

Camera	
Type	CMOS , Global shutter
Number of pixels	752 x 480 pixels
Gray scale	256

Functional safety related parameters

MTTF _d	20 a
Mission Time (T _M)	10 a
Diagnostic Coverage (DC)	0 %

Indicators/operating means

Operation indicator	LED green: Ready for operation
Function indicator	7 LEDs (communication, alignment aid, status information)
Control elements	Button for parameterization

Electrical specifications

Operating voltage	U _B	24 V DC +/- 15 % , PELV
No-load supply current	I ₀	max. 400 mA
Power consumption	P ₀	6 W

Interface

Interface type	100 BASE-TX PROFINET
Protocol	PROFINET IO Real-Time (RT) Conformance class A
Transfer rate	100 MBit/s

Standard conformity

Noise immunity	EN 61000-6-2:2005
----------------	-------------------

Ambient conditions

Operating temperature	0 ... 60 °C (32 ... 140 °F) , -20 ... 60 °C (-4 ... 140 °F) (noncondensing; prevent icing on the lens!)
Storage temperature	-30 ... 85 °C (-22 ... 185 °F)
Relative humidity	90 % , noncondensing

Mechanical specifications

Degree of protection	IP67
Material	
Housing	PC/ABS
Optical face	Plastic pane
Installation	4 x M6 threading
Mass	approx. 200 g

Approvals and certificates

UL approval	cULus Listed, General Purpose, Class 2 Power Source
CCC approval	CCC approval / marking not required for products rated ≤36 V
Approvals	CE

Curves / Diagrams

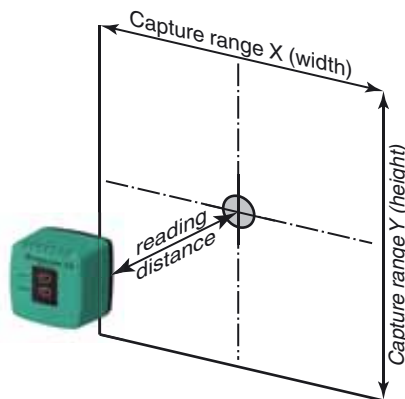

Accessories

V19-G-5M-PUR-ABG

Female cordset, M12, 8-pin, shielded, PUR cable

V1SD-G-2M-PUR-ABG-V1SD-G

Ethernet bus cable, M12 to M12, PUR cable 4-pin, CAT5e

V1SD-G-5M-PUR-ABG-V1SD-G

Ethernet bus cable, M12 to M12, PUR cable 4-pin, CAT5e

PCV-MB1

Mounting bracket for PCV* read head

PCV-SC12A

Grounding clip for PCV system

PCV-SC12

Grounding clip for PCV system

V19-G-2M-PUR-ABG

Female cordset, M12, 8-pin, shielded, PUR cable

V19-G-10M-PUR-ABG

Female cordset, M12, 8-pin, shielded, PUR cable

Other suitable accessories can be found at www.pepperl-fuchs.com

Dimensions

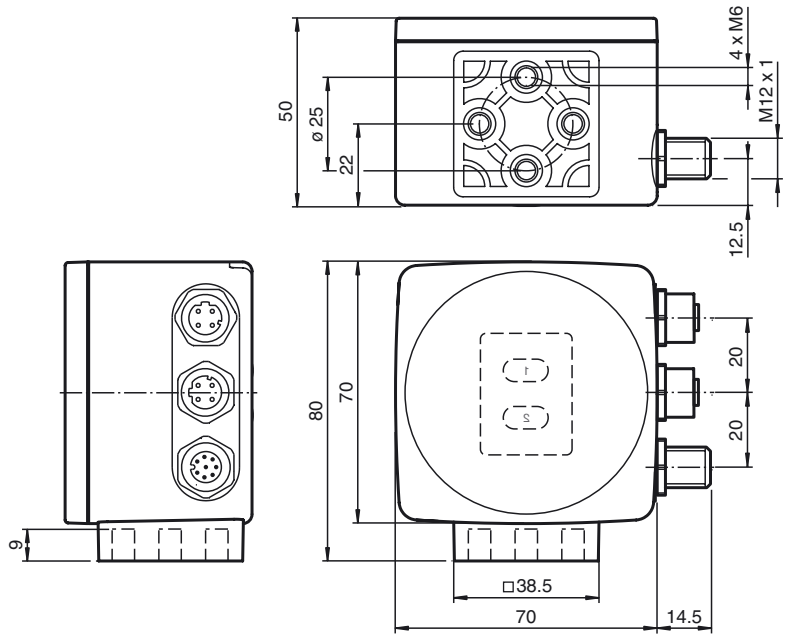

General

The PHA... Vision Sensor has been developed for the rack fine positioning of stock feeders. This device detects circular holes in the rack structure and determines the position deviation of these holes in relation to the target position. The Vision Sensor operates in two dimensions.

Mounting and Commissioning

Mount the PHA... Vision Sensor in such a way that the optical surface of the device captures the optimum distance to the carrier/hole (see "Technical Data"). The stability of the Vision Sensor mounting and the manner in which the vehicle is guided must ensure that the device is not operated outside of its depth of focus range.

All Vision Sensors can be adapted to optimally meet specific requirements by means of parameterization.

Indicators and Controls

The PHA... Vision Sensor is equipped with seven indicator LEDs for carrying out visual function checks and rapid diagnostics. The read head is equipped with two buttons at the back for activating the parameterization mode.

LEDs

LED	Color	Labeling	Meaning
1	yellow	BUS LINK	PROFINET communication active
2	yellow	BUS TX / RX	Data transfer
3	red	BUS ERR	PROFINET communication error
4	green/red	PWR/ERR	Fault with power supply/general error
5	yellow	ZERO POS	Zero position reached
6	yellow	RANGE	Within detection/capture range
7	red/green/yellow	INTERNAL DIAGNOSTIC	Internal diagnostics

External Parameterization

In order to parameterize the device externally, the parameterization code is required in the form of a data matrix containing the desired parameters. Data matrix code cards detailing the step-by-step process for externally parameterizing the device are printed in the operating instructions for the Vision Sensor.

- The Vision Sensor is switched over from normal operation to parameterization mode using button 2 on the back of the device. To switch the device over, button 2 must be pressed and held for more than two seconds. LED5 then flashes.

Note: Parameterization mode is exited automatically if the device is inactive for one minute. In this case, the Vision Sensor reverts to normal mode and operates without the settings having been changed.

- Place the parameterization code in the field of vision of the camera module. After the parameterization code is detected, the green LED4 lights up for one second. In the event of an invalid parameterization code, LED4 lights up red for two seconds.
- Briefly pressing button 2 will end parameterization mode. Unsaved changes will be lost.

Release date: 2018-10-17 16:40 Date of issue: 2018-10-22 266680_eng.xml