



Model Number

OBT350-R101-2EP-IO-0,3M-V1

Triangulation sensor (BGS)
with fixed cable and M12 connector, 4-pin

Features

- Miniature design with versatile mounting options
- Best background suppressor in its class
- Precision object detection, almost irrespective of the color
- Extended temperature range -40°C ... 60°C
- High degree of protection IP69K
- IO-link interface for service and process data

Product information

The miniature optical sensors are the first devices of their kind to offer an end-to-end solution in a small single standard design — from thru-beam sensor through to a distance measurement device. As a result of this design, the sensors are able to perform practically all standard automation tasks.

The DuraBeam laser sensors are durable and can be used in the same way as a standard sensor.

The use of Multi Pixel Technology gives the standard sensors a high level of flexibility and enables them to adapt more effectively to their operating environment.

Dimensions

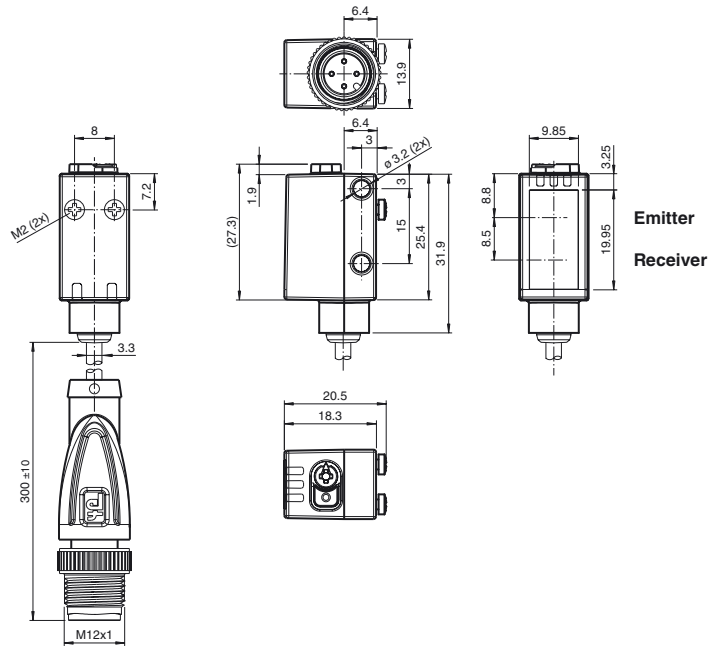

Electrical connection

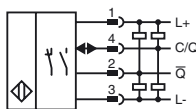

Pinout

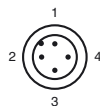

Wire colors in accordance with EN 60947-5-2

1	BN	(brown)
2	WH	(white)
3	BU	(blue)
4	BK	(black)

Indicators/operating means

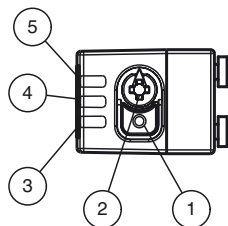

1	Light-on/dark-on changeover switch
2	Sensing range adjuster
3	Operating indicator / dark on
4	Signal indicator
5	Operating indicator / light on

Release date: 2018-12-17 14:14 Date of issue: 2018-12-17 267075-0097_eng.xml

Technical data

General specifications

Detection range	5 ... 350 mm
Detection range min.	5 ... 25 mm
Detection range max.	5 ... 350 mm
Adjustment range	25 ... 350 mm
Reference target	standard white, 100 mm x 100 mm
Light source	LED
Light type	modulated visible red light
LED risk group labelling	exempt group
Black/White difference (6%/90%)	< 15 % at 350 mm
Diameter of the light spot	approx. 20 mm at a distance of 350 mm
Angle of divergence	approx. 3 °
Ambient light limit	EN 60947-5-2 : 40000 Lux

Functional safety related parameters

MTTF _d	600 a
Mission Time (T _M)	20 a
Diagnostic Coverage (DC)	0 %

Indicators/operating means

Operation indicator	LED green: constantly on - power on flashing (4Hz) - short circuit flashing with short break (1 Hz) - IO-Link mode
Function indicator	LED yellow: constantly on - object detected constantly off - object not detected
Control elements	Light-on/dark-on changeover switch
Control elements	Sensing range adjuster

Electrical specifications

Operating voltage	U _B	10 ... 30 V DC
Ripple		max. 10 %
No-load supply current	I ₀	< 25 mA at 24 V supply voltage
Protection class		III

Interface

Interface type	IO-Link (via C/Q = pin 4)
Device profile	Smart Sensor
Transfer rate	COM 2 (38.4 kBaud)
IO-Link Revision	1.1
Min. cycle time	2.3 ms
Process data width	Process data input 1 Bit Process data output 2 Bit
SIO mode support	yes
Device ID	0x110601 (1115649)
Compatible master port type	A

Output

Switching type	The switching type of the sensor is adjustable. The default setting is: C/Q - Pin4: NPN normally open / light-on, PNP normally closed / dark-on, IO-Link /Q - Pin2: NPN normally closed / dark-on, PNP normally open / light-on	
Signal output	2 push-pull (4 in 1) outputs, short-circuit protected, reverse polarity protected, overvoltage protected	
Switching voltage	max. 30 V DC	
Switching current	max. 100 mA , resistive load	
Usage category	DC-12 and DC-13	
Voltage drop	U _d	≤ 1.5 V DC
Switching frequency	f	500 Hz
Response time		1 ms

Conformity

Communication interface	IEC 61131-9
Product standard	EN 60947-5-2

Ambient conditions

Ambient temperature	-40 ... 60 °C (-40 ... 140 °F) , fixed cable -25 ... 60 °C (-13 ... 140 °F) , movable cable not appropriate for conveyor chains
Storage temperature	-40 ... 70 °C (-40 ... 158 °F)

Mechanical specifications

Housing width	13.9 mm
Housing height	33.8 mm
Housing depth	18.3 mm
Degree of protection	IP67 / IP69 / IP69K
Connection	300 mm fixed cable with M12 x 1, 4-pin connector
Material	
Housing	PC (Polycarbonate)
Optical face	PMMA
Mass	approx. 17 g

Accessories

V1-G-2M-PUR

Female cordset, M12, 4-pin, PUR cable

V1-W-2M-PUR

Female cordset, M12, 4-pin, PUR cable

V31-GM-2M-PUR

Female cordset, M8, 4-pin, PUR cable

V31-WM-2M-PUR

Female cordset, M8, 4-pin, PUR cable

Other suitable accessories can be found at www.pepperl-fuchs.com

Release date: 2018-12-17 14:14 Date of issue: 2018-12-17 267075-0097_eng.xml

Cable length 0.3 m

Approvals and certificates

UL approval E87056 , cULus Listed , class 2 power supply , type rating 1

Curves/Diagrams

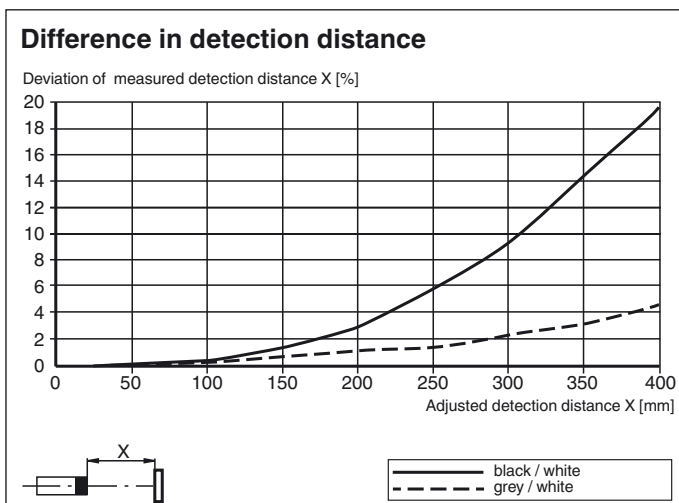
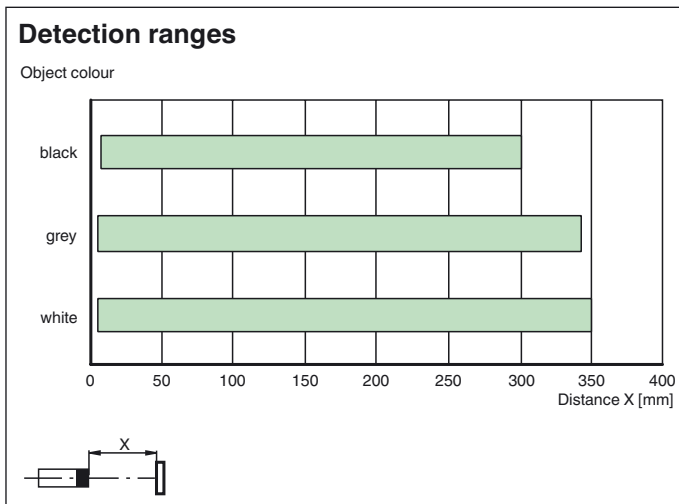
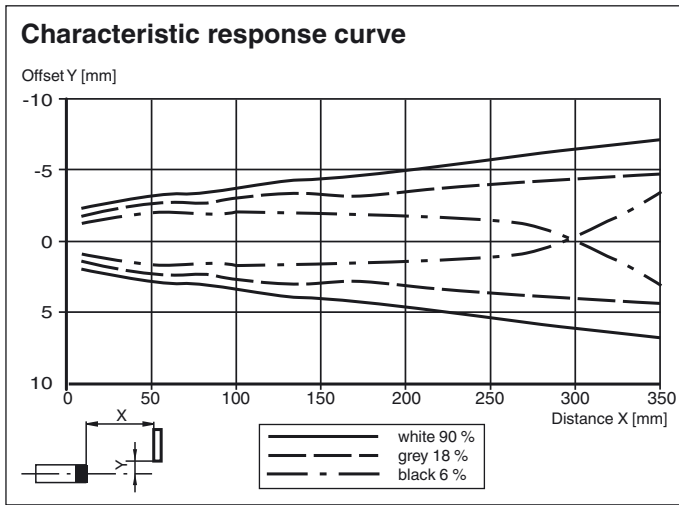

Release date: 2018-12-17 14:14 Date of issue: 2018-12-17 267075-0097_eng.xml

Refer to "General Notes Relating to Pepperl+Fuchs Product Information".

Pepperl+Fuchs Group
www.pepperl-fuchs.com

USA: +1 330 486 0001
fa-info@us.pepperl-fuchs.com

Germany: +49 621 776 4411
fa-info@de.pepperl-fuchs.com

Singapore: +65 6779 9091
fa-info@sg.pepperl-fuchs.com

Functions and Operation

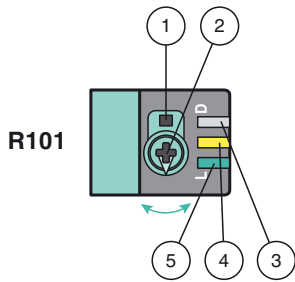

- 1 - Light-on / dark-on changeover switch
- 2 - Sensing range /sensitivity adjuster
- 3 - Operating indicator / dark on
- 4 - Signal indicator
- 5 - Operating indicator / light on

To unlock the adjustment functions turn the sensing range adjuster for more than 180 degrees.

Sensing Range / Sensitivity

Turn sensing range / sensitivity adjuster clockwise to increase sensing range / sensitivity.

Turn sensing range /sensitivity adjuster counter clockwise to decrease sensing range / sensitivity.

If the end of the adjustment range is reached, the signal indicator starts flashing with 8 Hz.

Light-on / Dark-on Configuration

Press the light-on / dark-on changeover switch for more than 1 second (less than 4 seconds). The light-on / dark-on mode changes and the operating indicators are activated accordingly.

If you press the light-on / dark-on changeover switch for more than 4 seconds, the light-on / dark-on mode changes back to the original setting. On release of the light-on / dark-on changeover switch the current state is activated.

Restore Factory Settings

Press the light-on / dark-on changeover switch for more than 10 seconds (less than 30 seconds) until all LEDs turn off. On release of the light-on / dark-on changeover switch the signal indicator turns on. After 5 seconds the sensor resumes operation with factory default settings.

After 5 minutes of inactivity the sensing range / sensitivity adjustment is locked. In order to reactivate the sensing range /sensitivity adjustment, turn the sensing range / sensitivity adjuster for more than 180 degrees.