



Model Number

QQT120-R103-2EP-IO-0,3M-V31-L
 Triangulation sensor (SbR)
 with fixed cable and 4-pin, M8 connector

Features

- Miniature design with versatile mounting options
- Multi Pixel Technology (MPT) - flexibility and adaptability
- Reduction of device variety - several switch points within one sensor
- DuraBeam Laser Sensors - durable and employable like an LED
- Reliable detection of all surfaces, independent of color and structure
- IO-link interface for service and process data

Product information

The R103 series miniature optical sensors are the first devices of their kind to offer an end-to-end solution in a small single standard design — from thru-beam sensor through to a distance measurement device. As a result of this design, the sensors are able to perform practically all standard automation tasks. The entire series enables sensors to communicate via IO-Link. The DuraBeam laser sensors are durable and can be used in the same way as a standard sensor. The use of Multi Pixel Technology gives the standard sensors a high level of flexibility and enables them to adapt more effectively to their operating environment.

Dimensions

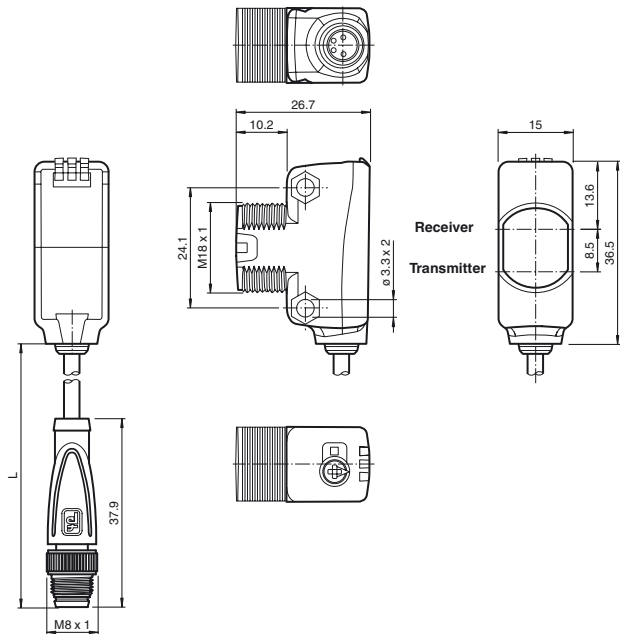

Electrical connection

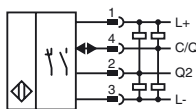

Pinout

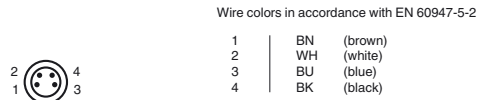

Indicators/operating means

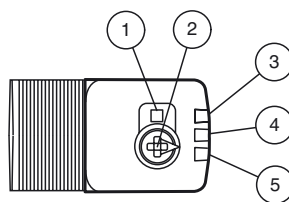

1	Teach-in button
2	Mode rotary switch
3	Switch output indicator Q2
4	Switch output indicator Q1
5	Operating indicator

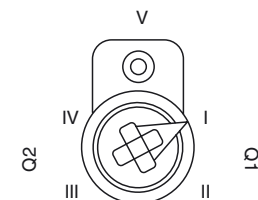

I	Switch output 1 / switch point B
II	Switch output 1 / switch point A
III	Switch output 2 / switch point A
IV	Switch output 2 / switch point B
V	Keylock

Release date: 2018-06-08 14:46 Date of issue: 2018-06-08 267075-100361_eng.xml

Technical data**General specifications**

Detection range	8 ... 120 mm
Detection range min.	8 ... 20 mm
Detection range max.	8 ... 120 mm
Adjustment range	20 ... 120 mm
Reference target	standard white, 100 mm x 100 mm
Light source	laser diode
Light type	modulated visible red light
Laser nominal ratings	
Note	LASER LIGHT , DO NOT STARE INTO BEAM
Laser class	1
Wave length	680 nm
Beam divergence	> 5 mrad ; d63 < 1 mm in the range of 50 mm ... 250 mm
Pulse length	3 µs
Repetition rate	approx. 3 kHz
max. pulse energy	15.2 nJ
Black/White difference (6 %/90 %)	< 3 % at 120 mm
Diameter of the light spot	approx. 2 mm at a distance of 120 mm
Angle of divergence	approx. 1 °
Ambient light limit	EN 60947-5-2 : 30000 Lux

Functional safety related parameters

MTTF _d	560 a
Mission Time (T _M)	20 a
Diagnostic Coverage (DC)	0 %

Indicators/operating means

Operation indicator	LED green: constantly on - power on flashing (4Hz) - short circuit flashing with short break (1 Hz) - IO-Link mode
Function indicator	LED yellow: constantly on - switch output active constantly off - switch output inactive
Control elements	Teach-In key
Control elements	5-step rotary switch for operating modes selection

Electrical specifications

Operating voltage	U _B	10 ... 30 V DC
Ripple		max. 10 %
No-load supply current	I ₀	< 20 mA at 24 V supply voltage
Protection class		III

Interface

Interface type	IO-Link (via C/Q = pin 4)
Device profile	Smart Sensor
Transfer rate	COM 2 (38.4 kBaud)
IO-Link Revision	1.1
Min. cycle time	2.3 ms
Process data width	Process data input 2 Bit Process data output 2 Bit
SIO mode support	yes
Device ID	0x110804 (1116164)
Compatible master port type	A

Output

Switching type	The default setting is: C/Q - Pin4: NPN normally open, PNP normally closed, IO-Link Q2 - Pin2: NPN normally open, PNP normally closed	
Signal output	2 push-pull (4 in 1) outputs, short-circuit protected, reverse polarity protected, overvoltage protected	
Switching voltage	max. 30 V DC	
Switching current	max. 100 mA , resistive load	
Usage category	DC-12 and DC-13	
Voltage drop	U _d	≤ 1.5 V DC
Switching frequency	f	217 Hz
Response time		2.3 ms

Conformity

Communication interface	IEC 61131-9
Product standard	EN 60947-5-2
Laser safety	EN 60825-1:2014

Ambient conditions

Ambient temperature	-40 ... 60 °C (-40 ... 140 °F) , fixed cable -25 ... 60 °C (-13 ... 140 °F) , movable cable not appropriate for conveyor chains
Storage temperature	-40 ... 70 °C (-40 ... 158 °F)

Mechanical specifications

Housing width	15 mm
Housing height	36.5 mm
Housing depth	26.7 mm

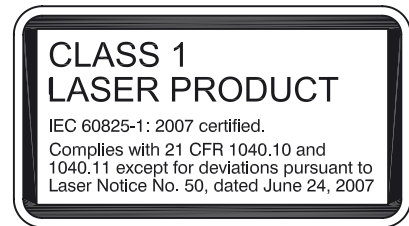
Laserlabel**Accessories****IO-Link-Master02-USB**

IO-Link master, supply via USB port or separate power supply, LED indicators, M12 plug for sensor connection

OMH-R103-01

Mounting bracket

V31-GM-2M-PUR

Female cordset, M8, 4-pin, PUR cable

V31-WM-2M-PUR

Female cordset, M8, 4-pin, PUR cable

OMH-R101-Front

Mounting Clamp

OMH-R101

Mounting Clamp

OMH-4.1

Mounting Clamp

OMH-ML6

Mounting bracket

OMH-ML6-U

Mounting bracket

OMH-ML6-Z

Mounting bracket

Other suitable accessories can be found at www.pepperl-fuchs.com

Degree of protection	IP67 / IP69 / IP69K
Connection	fixed cable 300 mm with M8 x 1 male connector; 4-pin
Material	
Housing	PC (Polycarbonate)
Optical face	PMMA
Mass	approx. 17 g
Cable length	0.3 m

Approvals and certificates

UL approval	E87056 , cULus Listed , class 2 power supply , type rating 1
FDA approval	IEC 60825-1:2007 Complies with 21 CFR 1040.10 and 1040.11 except for deviations pursuant to Laser Notice No. 50, dated June 24, 2007

Curves/Diagrams

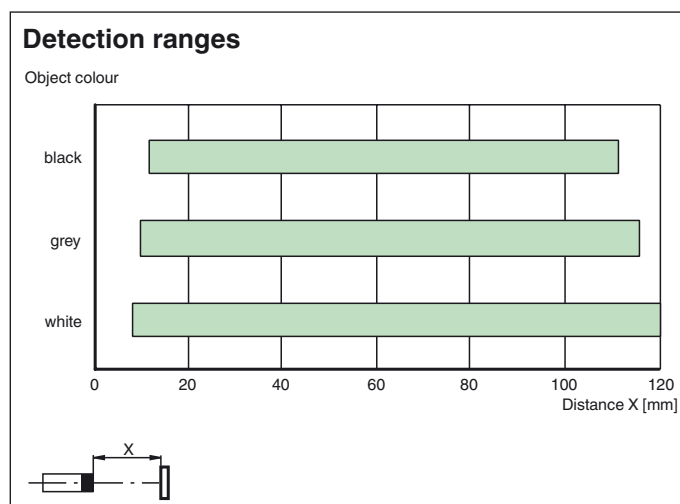
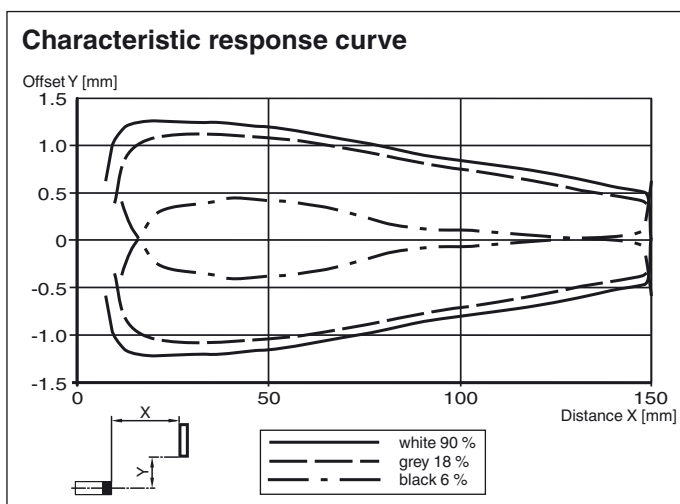

Preferences

Teach-In:

You can use the rotary switch to select the relevant switching threshold A and/or B for teaching in for switch signal **Q1** or **Q2**. The yellow LEDs indicate the current state of the selected output. To store a threshold value, press and hold the "TI" button until the yellow and green LEDs flash in phase (approx. 1 s). Teach-In starts when the "TI" button is released. Successful Teach-In is indicated by alternating flashing (2.5 Hz) of the yellow and green LEDs. An unsuccessful Teach-In is indicated by rapidly alternating flashing (8 Hz) of the yellow and green LEDs. After an unsuccessful Teach-In, the sensor continues to operate with the previous valid setting after the relevant visual fault signal is issued. Different switching modes can be defined by teaching in the relevant distance measured values for the switching thresholds A and B:

Single point mode:

Release date: 2018-06-08 14:46 Date of issue: 2018-06-08 267075-100361_eng.xml

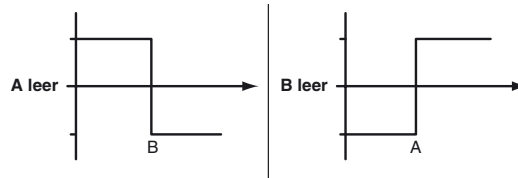

Window mode:

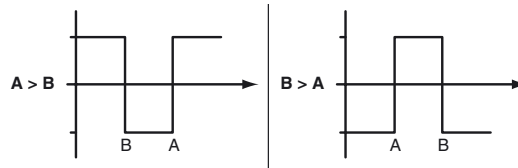

Every taught-in switching threshold can be retaught (overwritten) by pressing the „TI“ button again.

Pressing and holding the "TI" button for > 4 s completely deletes the taught-in value. The yellow and green LEDs go out simultaneously to indicate that this procedure has been completed. Successful resetting is indicated by alternating flashing (2.5 Hz) of the yellow and green LEDs.

Resetting to Factory Default Settings

Press the „TI“ button for > 10 s in rotary switch position ‚O‘ to reset to factory default settings. The yellow and green LEDs go out simultaneously to indicate the resetting.

Resetting process starts when the "TI" button is released and is indicated by the yellow LED. After the process the sensor works with factory default settings, immediately.

OMT:

- Factory default settings switch signal Q1: Switch signal active, window mode
- Factory default settings switch signal Q2: Switch signal active, window mode

OQT:

- Factory default settings switch signal Q1: Switch signal active, BGS mode (background suppression)
- Factory default settings switch signal Q2: Switch signal active, BGS mode (background suppression)

Configuration via IO-Link interface

Configuring different operating modes via the IO-Link interface

The devices are equipped with an IO-Link interface as standard for diagnostics and parameterization tasks to ensure optimum adjustment of the sensors to the relevant application. Four different operating modes can be set, among other features:

Background suppression operating mode (one switch point):

- Detection of objects irrespective of type and color in a defined detection range. Objects in the background are suppressed.



Background evaluation operating mode (one switch point):

- Detection of objects irrespective of type and color against a defined background. Reliable detection of objects at close range (detection range >= 0 mm). The background serves as reference.



Single point mode operating mode (one switch point):

- Detection of objects irrespective of type and color in a defined detection range. Objects in the background are suppressed.
- The switch point corresponds exactly to the set point.



Window mode operating mode (two switch points):

- Detection of objects irrespective of type and color in a defined detection range. Reliable detection when object leaves the detection range.
- Window mode with two switch points.



Center window mode operating mode (one switch point):

- Detection of objects irrespective of type and color in a defined detection range. Sets a defined window around a given object. Objects outside

Release date: 2018-06-08 14:46 Date of issue: 2018-06-08 267075-100361_eng.xml

this window are not detected.

- Window mode with one switch point.



Two point mode operating mode (hysteresis operating mode):

- Detection of objects irrespective of type and color between a defined switch-on and switch-off point.

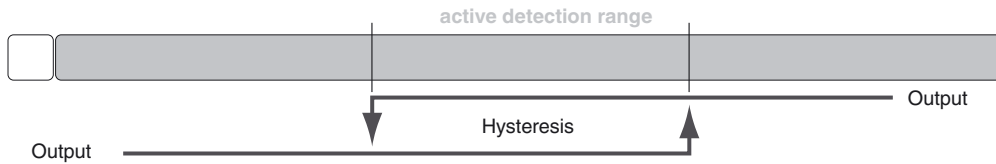

Inactive operating mode:

- Evaluation of switching signals is deactivated.

The associated IODD device description file can be found in the download area at www.pepperl-fuchs.com.