



Model Number

OBE1000-R2-SE2-0,2M-V31-L

Laser thru-beam sensor
with fixed cable and 4-pin, M8 connector

Features

- Ultra-small housing design
- DuraBeam Laser Sensors - durable and employable like an LED
- 45° cable outlet for maximum mounting freedom under extremely tight space constraints
- Improvement in machine availability with abrasion-resistant, antistatic glass front

Product information

The R2 series nano sensor has been developed for a broad range of applications. It offers excellent durability and is exceptionally easy to install. The housing is compact and, with its 45° cable outlet, can be installed in the smallest spaces. New functional principles and functionality open up a range of new options. The DuraBeam laser sensors are durable and can be used in the same way as a standard sensor. The abrasion-resistant lens allows long operating times close to the moving object.

Release date: 2017-03-02 15:31 Date of issue: 2017-03-02 282042_eng.xml

Dimensions

Transmitter

Receiver

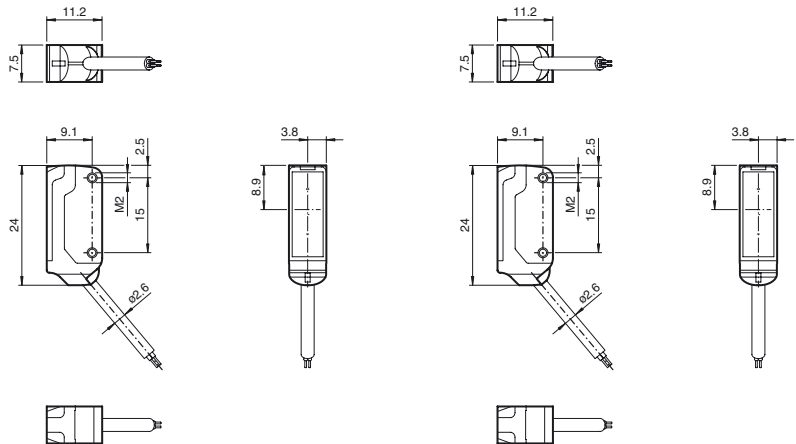

Electrical connection



Pinout



Wire colors in accordance with EN 60947-5-2

- 1 | BN (brown)
- 2 | WH (white)
- 3 | BU (blue)
- 4 | BK (black)

Indicators/operating means

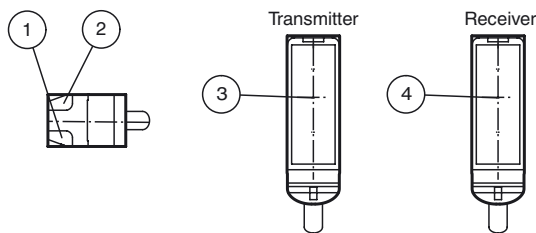

1	Operating display	green
2	Signal display	yellow
3	Emitter	
4	Receiver	

Technical data**System components**

Emitter	OBE10M-R2-0M2-V31-L
Receiver	OBE1000-R2-E2-0M2-V31-L

General specifications

Effective detection range	0 ... 1 m
Threshold detection range	1.5 m
Light source	laser diode
Light type	modulated visible red light , 680 nm

Laser nominal ratings

Note	LASER LIGHT , DO NOT STARE INTO BEAM
Laser class	1
Wave length	680 nm
Beam divergence	> 5 mrad
Pulse length	approx. 2 μ s
Repetition rate	approx. 16.6 kHz
max. pulse energy	9.5 nJ
Diameter of the light spot	approx. 3 mm at a distance of 1000 mm
Angle of divergence	approx. 0.5 °
Optical face	frontal
Ambient light limit	EN 60947-5-2 : 30000 Lux

Functional safety related parameters

MTTF _d	806 a
Mission Time (T _M)	20 a
Diagnostic Coverage (DC)	0 %

Indicators/operating means

Operation indicator	LED green, statically lit Power on , short-circuit : LED green flashing (approx. 4 Hz)
Function indicator	Receiver: LED yellow, lights up when light beam is free, flashes when falling short of the stability control ; OFF when light beam is interrupted

Electrical specifications

Operating voltage	U _B	12 ... 24 V
No-load supply current	I ₀	Emitter: ≤ 10 mA Receiver: ≤ 8 mA
Protection class		III

Input

Test input	Test of switching function at 0 V
Switching threshold	Teach-In input

Output

Switching type	NO contact	
Signal output	1 PNP output, short-circuit protected, reverse polarity protected, open collector	
Switching voltage	max. 30 V DC	
Switching current	max. 50 mA , resistive load	
Voltage drop	U _d	≤ 1.5 V DC
Switching frequency	f	approx. 2 kHz
Response time		250 μ s

Directive conformity

Electromagnetic compatibility	
Directive 2014/30/EU	EN 60947-5-2:2007 EN 60947-5-2/A1:2012

Standard conformity

Standards	EN 60947-5-2:2007 EN 60947-5-2/A1:2012 EN 60825-1:2007 UL 60947-5-2: 2014
-----------	---

Ambient conditions

Ambient temperature	-20 ... 60 °C (-4 ... 140 °F)
Storage temperature	-30 ... 70 °C (-22 ... 158 °F)

Mechanical specifications

Degree of protection	IP67
Connection	200 mm fixed cable with 4-pin, M8x1 connector
Material	
Housing	PC/ABS and TPU
Optical face	glass
Cable	PUR
Installation	Fixing screws , 2 x M2 allen head screws included with delivery
Mass	approx. 10 g Per sensor
Cable length	200 mm

Approvals and certificates

UL approval	E87056 , cULus Recognized, Class 2 Power Source
CCC approval	CCC approval / marking not required for products rated ≤36 V
FDA approval	IEC 60825-1:2007 Complies with 21 CFR 1040.10 and 1040.11 except for deviations pursuant to Laser Notice No. 50, dated June 24, 2007

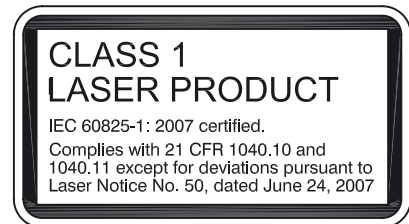
Laserlabel**Accessories****V31-WM-2M-PUR**

Female cordset, M8, 4-pin, PUR cable

MH-R2-01

Mounting aid for R2 series, Mounting bracket

MH-R2-02

Mounting aid for R2 series, Mounting bracket

MH-R2-03

Mounting aid for R2 series, Mounting bracket

MH-R2-04

Mounting aid for R2 series, Mounting bracket

Other suitable accessories can be found at www.pepperl-fuchs.com

Curves/Diagrams

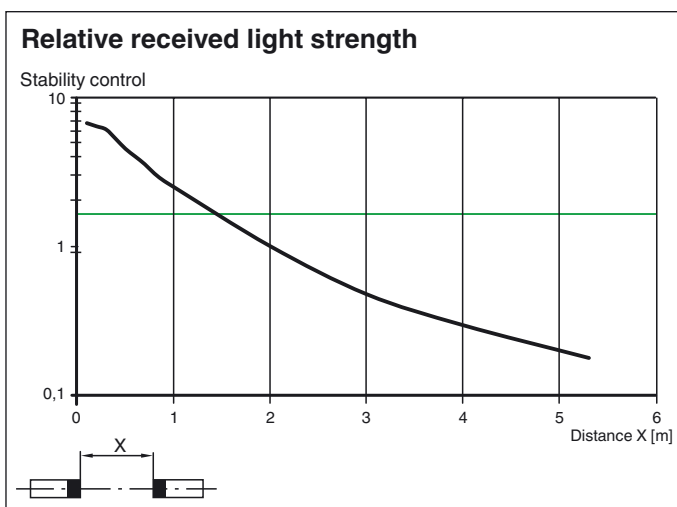
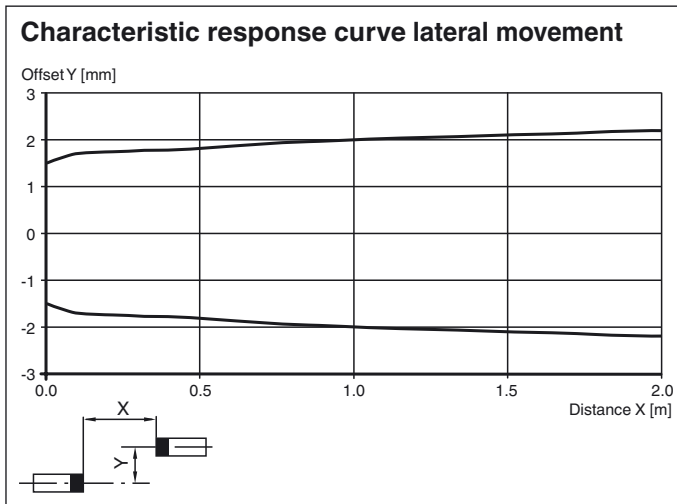

Teach-In Methods

The thru-beam sensor enables the switching points to be taught in for optimum adaptation to specific applications. This eliminates the need for additional components such as apertures.

The sensitivity of the thru-beam sensor can be adjusted using three Teach-in methods:

Position Teach

When using this Teach-in method, the following settings are made on the thru-beam sensor:

- The gain is set to an optimum value
- The signal threshold is set to a minimum

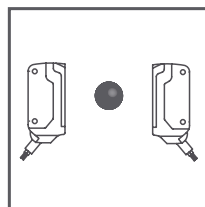
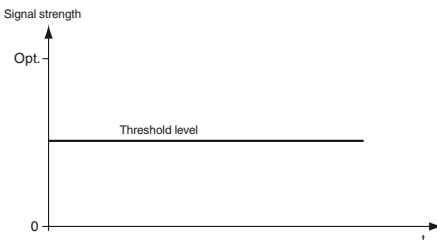

Recommended application:

This method enables minuscule particles in the beam path to be detected, and provides exceptional positioning accuracy. Make sure that there are no objects in the beam path and that the sensor is connected to the power supply.

1. Connect the white cable on the receiver (WH/IN) to the blue cable (BU/0 V) on the receiver. The green and yellow LED indicators flash simultaneously at 2.5 Hz
2. Disconnect the white cable on the receiver (WH/IN) from the blue cable (BU/0 V) on the receiver. The green and yellow LED indicators flash alternately at 2.5 Hz
3. The end of the Teach-in process is indicated when the green LED indicator lights up solid and yellow LED blinks.

Two-Point Teach-In

When using this Teach-in method, the following settings are made on the thru-beam sensor:

- The gain is set to an optimum value
- The signal threshold is set in the center between the two taught signal values

Release date: 2017-03-02 15:31 Date of issue: 2017-03-02 282042_eng.xml

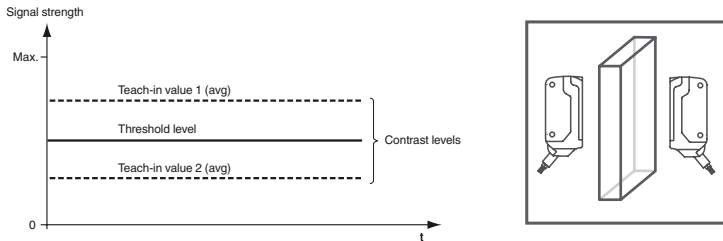

1. Make sure that there are no objects in the beam path and that the sensor is connected to the power supply.
2. Connect the white cable on the receiver (WH/IN) to the blue cable (BU/0 V) on the receiver. The green and yellow LED indicators flash simultaneously at 2.5 Hz
3. Position the object in the beam path.
4. Disconnect the white cable on the receiver (WH/IN) from the blue cable (BU/0 V) on the receiver. The green and yellow LED indicators flash alternately at 2.5 Hz
5. The end of the Teach-in process is indicated when the green LED indicator lights up solid.

Maximum Teach-In

When using this Teach-in method, the following settings are made on the thru-beam sensor:

- The gain is set to a maximum
- The signal threshold is set to a minimum

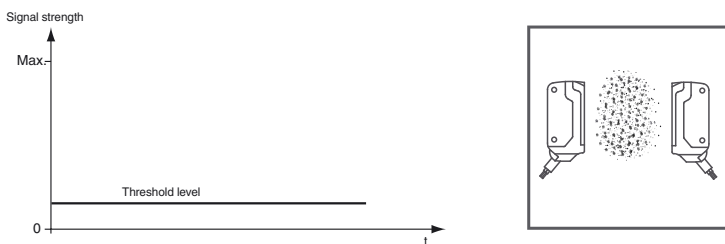

Recommended application:

Enables an object to be detected with a high excess gain. This can be useful if there is severe environmental contamination or to achieve long operating times.

Make sure that there are no objects in the beam path and that the sensor is connected to the power supply.

6. Cover the receiver or transmitter.
7. Connect the white cable on the receiver (WH/IN) to the blue cable (BU/0 V) on the receiver. The green and yellow LED indicators flash simultaneously at 2.5 Hz
8. Disconnect the white cable on the receiver (WH/IN) from the blue cable (BU/0 V) on the receiver. The green and yellow LED indicators flash alternately at 2.5 Hz
9. The end of the Teach-in process is indicated when the green LED indicator lights up solid.

Laser notice laser class 1

- The irradiation can lead to irritation especially in a dark environment. Do not point at people!
- Maintenance and repairs should only be carried out by authorized service personnel!
- Attach the device so that the warning is clearly visible and readable.
- The warning accompanies the device and should be attached in immediate proximity to the device.
- Caution – Use of controls or adjustments or performance of procedures other than those specified herein may result in hazardous radiation exposure.

Release date: 2017-03-02 15:31 Date of issue: 2017-03-02 282042_eng.xml