



**Model Number**

**OBT15-R3-E2-0,2M-V31-L**

Laser triangulation sensor with background suppression  
with fixed cable and 4-pin, M8 connector

**Features**

- Ultra-small housing design
- DuraBeam Laser Sensors - durable and employable like an LED
- 45° cable outlet for maximum mounting freedom under extremely tight space constraints
- Improvement in machine availability with abrasion-resistant, antistatic glass front
- Extremely small light spot for very high switching point accuracy
- Precision object detection, almost irrespective of the color

**Product information**

The R3 series nano sensor has been developed for a broad range of applications. It offers excellent durability and is exceptionally easy to install. The housing is compact and, with its 45° cable outlet, can be installed in the smallest spaces. New functional principles and functionality open up a range of new options. The DuraBeam laser sensors are durable and can be used in the same way as a standard sensor. The abrasion-resistant lens allows long operating times close to the moving object.

**Dimensions**

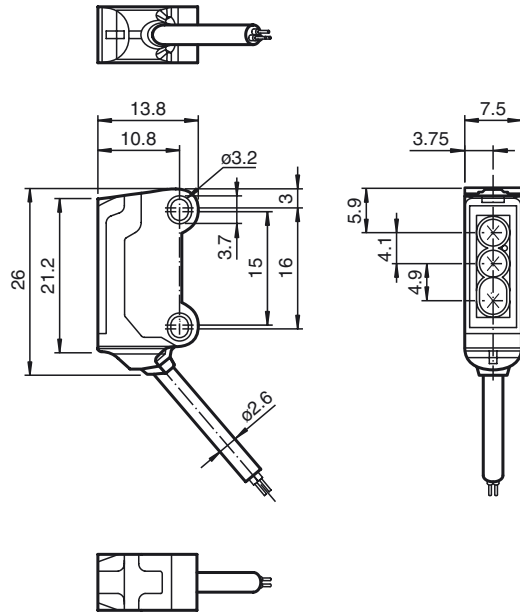

**Electrical connection**

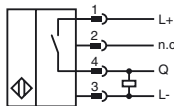

**Pinout**

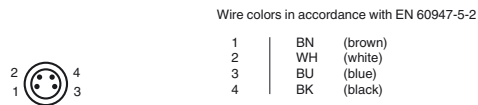

**Indicators/operating means**

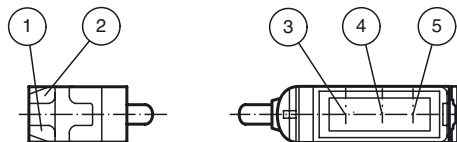

1	Operating display	green
2	Signal display	yellow
3	Emitter	
4	Receiver 1	
5	Receiver 2	

Release date: 2017-03-02 14:35 Date of issue: 2017-03-02 282055\_eng.xml

Refer to "General Notes Relating to Pepperl+Fuchs Product Information".

Pepperl+Fuchs Group  
www.pepperl-fuchs.com

USA: +1 330 486 0001  
fa-info@us.pepperl-fuchs.com

Germany: +49 621 776 4411  
fa-info@de.pepperl-fuchs.com

Singapore: +65 6779 9091  
fa-info@sg.pepperl-fuchs.com

**Technical data****General specifications**

Detection range	7 ... 15 mm
Reference target	standard white, 100 mm x 100 mm
Light source	laser diode
Light type	modulated visible red light , 680 nm
<b>Laser nominal ratings</b>	
Note	LASER LIGHT , DO NOT STARE INTO BEAM
Laser class	1
Wave length	680 nm
Beam divergence	> 5 mrad
Pulse length	approx. 3 µs
Repetition rate	approx. 16.6 kHz
max. pulse energy	9.5 nJ
Black/White difference (6%/90%)	< 3 % at 15 mm
Diameter of the light spot	approx. 1.5 mm at a distance of 15 mm
Angle of divergence	approx. 2 °
Optical face	frontal
Ambient light limit	EN 60947-5-2 : 30000 Lux

**Functional safety related parameters**

MTTF <sub>d</sub>	800 a
Mission Time (T <sub>M</sub> )	20 a
Diagnostic Coverage (DC)	0 %

**Indicators/operating means**

Operation indicator	LED green, statically lit Power on , short-circuit : LED green flashing (approx. 4 Hz)
Function indicator	LED yellow: lights when object is detected

**Electrical specifications**

Operating voltage	U <sub>B</sub>	12 ... 24 V
No-load supply current	I <sub>0</sub>	< 10 mA
Protection class		III

**Output**

Switching type		NO contact
Signal output		1 PNP output, short-circuit protected, reverse polarity protected, open collector
Switching voltage		max. 30 V DC
Switching current		max. 50 mA , resistive load
Voltage drop	U <sub>d</sub>	≤ 1.5 V DC
Switching frequency	f	approx. 2 kHz
Response time		250 µs

**Directive conformity**

Electromagnetic compatibility	
Directive 2014/30/EU	EN 60947-5-2:2007 EN 60947-5-2/A1:2012

**Standard conformity**

Standards	EN 60947-5-2:2007 EN 60947-5-2/A1:2012 EN 60825-1:2007 UL 60947-5-2: 2014
-----------	---

**Ambient conditions**

Ambient temperature	-20 ... 60 °C (-4 ... 140 °F)
Storage temperature	-30 ... 70 °C (-22 ... 158 °F)

**Mechanical specifications**

Degree of protection	IP67
Connection	200 mm fixed cable with 4-pin, M8x1 connector
<b>Material</b>	
Housing	PC/ABS and TPU
Optical face	glass
Cable	PUR
Mass	approx. 10 g
Cable length	200 mm

**Approvals and certificates**

UL approval	E87056 , cULus Recognized, Class 2 Power Source
CCC approval	CCC approval / marking not required for products rated ≤36 V
FDA approval	IEC 60825-1:2007 Complies with 21 CFR 1040.10 and 1040.11 except for deviations pursuant to Laser Notice No. 50, dated June 24, 2007

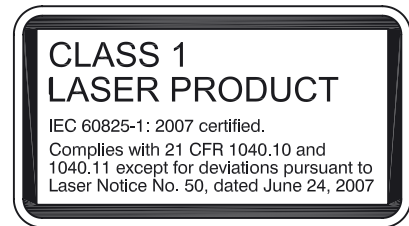
**Laserlabel****Accessories****V31-WM-2M-PUR**

Female cordset, M8, 4-pin, PUR cable

**MH-R3-01**

Mounting aid for sensors from the R3 series, mounting bracket

**MH-R3-02**

Mounting aid for sensors from the R3 series, mounting bracket

**MH-R3-03**

Mounting aid for sensors from the R3 series, mounting bracket

**MH-R3-04**

Mounting aid for sensors from the R3 series, mounting bracket

Other suitable accessories can be found at [www.pepperl-fuchs.com](http://www.pepperl-fuchs.com)

## Curves/Diagrams

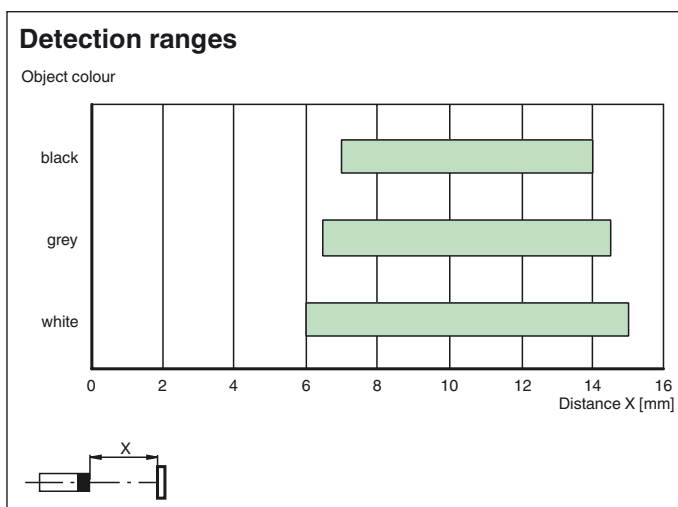
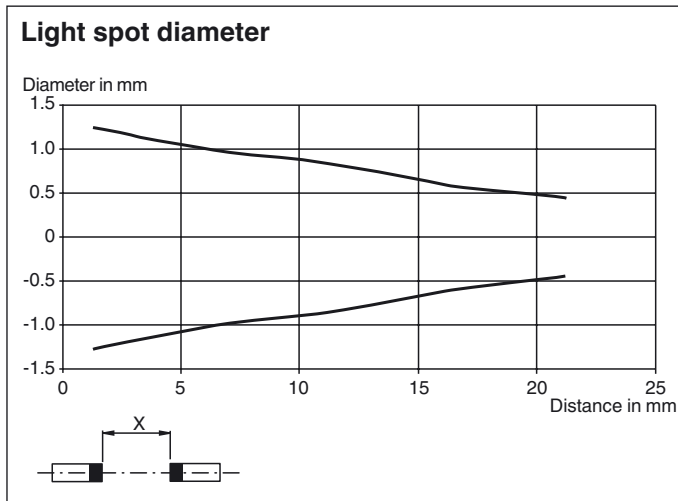

## Laser notice laser class 1

- The irradiation can lead to irritation especially in a dark environment. Do not point at people!
- Maintenance and repairs should only be carried out by authorized service personnel!
- Attach the device so that the warning is clearly visible and readable.
- The warning accompanies the device and should be attached in immediate proximity to the device.
- Caution – Use of controls or adjustments or performance of procedures other than those specified herein may result in hazardous radiation exposure.