



Model Number

OQT400-R201-EP-IO-0,3M-V3

Triangulation sensor (SbR)
with fixed cable and 3-pin, M8 connector

Features

- Medium design with versatile mounting options
- Multi Pixel Technology (MPT) - flexibility and adaptability
- Reduction of device variety - several switch points within one sensor
- Reliable detection of all surfaces, independent of color and structure
- Low sensitivity to target color
- IO-link interface for service and process data

Product information

The optical sensors in the series are the first devices to offer an end-to-end solution in a medium-sized standard design—from the thru-beam sensor through to the measuring distance sensor. As a result of this design, the sensors are able to perform practically all standard automation tasks.

The entire series enables sensors to communicate via IO-Link.

The DuraBeam laser sensors are durable and can be used in the same way as a standard sensor.

Multi Pixel Technology (MPT) ensures that the standard sensors are flexible and can be adapted to the application environment.

Dimensions

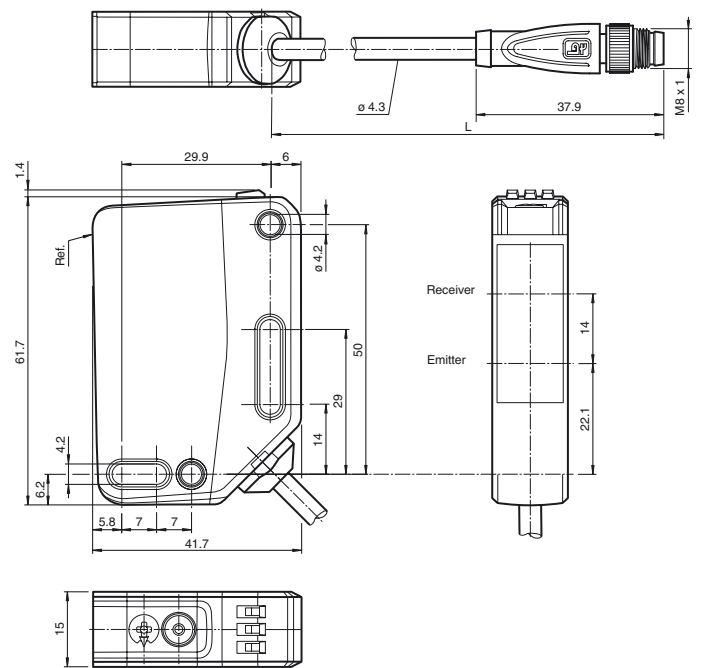

Electrical connection

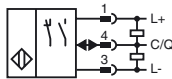

Pinout



Wire colors in accordance with EN 60947-5-2

- 1 | BN (brown)
- 3 | BU (blue)
- 4 | BK (black)

Indicators/operating means

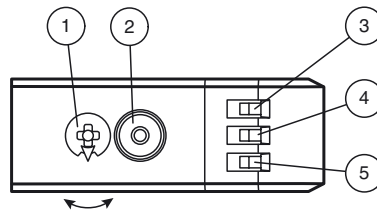

1	Mode rotary switch	
2	Teach-in button	
3	Switching output display Q2	YE
4	Switching output display Q1	YE
5	Operating indicator	GN

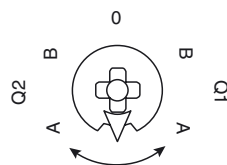

Q1B	Switching output 1/switch point B
Q1A	Switching output 1/switch point A
Q2A	Switching output 2/switch point A
Q2B	Switching output 2/switch point B
0	Keylock

Release date: 2018-07-27 10:13 Date of issue: 2018-07-27 295670-100166_eng.xml

Refer to "General Notes Relating to Pepperl+Fuchs Product Information".

Pepperl+Fuchs Group
www.pepperl-fuchs.com

USA: +1 330 486 0001
fa-info@us.pepperl-fuchs.com

Germany: +49 621 776 4411
fa-info@de.pepperl-fuchs.com

Singapore: +65 6779 9091
fa-info@sg.pepperl-fuchs.com

Technical data**General specifications**

Detection range	40 ... 400 mm
Detection range min.	40 ... 100 mm
Detection range max.	40 ... 400 mm
Adjustment range	100 ... 400 mm
Reference target	standard white, 100 mm x 100 mm
Light source	LED
Light type	modulated visible red light
LED risk group labelling	exempt group
Black/White difference (6%/90%)	< 5 %

Diameter of the light spot	approx. 15 mm at a distance of 400 mm
Angle of divergence	approx. 2.5 °
Ambient light limit	EN 60947-5-2 : 70000 Lux

Functional safety related parameters

MTTF _d	600 a
Mission Time (T _M)	20 a
Diagnostic Coverage (DC)	0 %

Indicators/operating means

Operation indicator	LED green: constantly on - power on flashing (4Hz) - short circuit flashing with short break (1 Hz) - IO-Link mode
Function indicator	LED yellow: constantly on - switch output active constantly off - switch output inactive
Control elements	Teach-In key
Control elements	5-step rotary switch for operating modes selection

Electrical specifications

Operating voltage	U _B	10 ... 30 V DC
Ripple		max. 10 %
No-load supply current	I ₀	< 25 mA at 24 V supply voltage
Protection class		III

Interface

Interface type	IO-Link (via C/Q = pin 4)
Device profile	Identification and diagnosis Smart Sensor type 0
Transfer rate	COM 2 (38.4 kBaud)
IO-Link Revision	1.1
Min. cycle time	2.3 ms
Process data width	Process data input 2 Bit Process data output 2 Bit
SIO mode support	yes
Device ID	0x111811 (1120273)
Compatible master port type	A

Output

Switching type	The default setting is: C/Q - Pin4: NPN normally open, PNP normally closed, IO-Link	
Signal output	1 push-pull (4 in 1) output, short-circuit protected, reverse polarity protected, overvoltage protected	
Switching voltage	max. 30 V DC	
Switching current	max. 100 mA , resistive load	
Usage category	DC-12 and DC-13	
Voltage drop	U _d	≤ 1.5 V DC
Switching frequency	f	217 Hz
Response time		2.3 ms

Conformity

Communication interface	IEC 61131-9
Product standard	EN 60947-5-2

Ambient conditions

Ambient temperature	-40 ... 60 °C (-40 ... 140 °F) , fixed cable -20 ... 60 °C (-4 ... 140 °F) , movable cable not appropriate for conveyor chains
Storage temperature	-40 ... 70 °C (-40 ... 158 °F)

Mechanical specifications

Housing width	15 mm
Housing height	61.7 mm
Housing depth	41.7 mm
Degree of protection	IP67 / IP69 / IP69K
Connection	300 mm fixed cable with M8 x 1, 3-pin connector
Material	
Housing	PC (Polycarbonate)
Optical face	PMMA
Mass	approx. 55 g

Accessories**V3-GM-2M-PUR**

Cable socket, M8, 3-pin, PUR cable

V3-WM-2M-PUR

Cable socket, M8, 3-pin, PUR cable

IO-Link-Master02-USB

IO-Link master, supply via USB port or separate power supply, LED indicators, M12 plug for sensor connection

Other suitable accessories can be found at www.pepperl-fuchs.com

Cable length 0.3 m

Approvals and certificates

UL approval E87056 , cULus Listed , class 2 power supply , type rating 1
 CCC approval CCC approval / marking not required for products rated ≤36 V

Curves/Diagrams

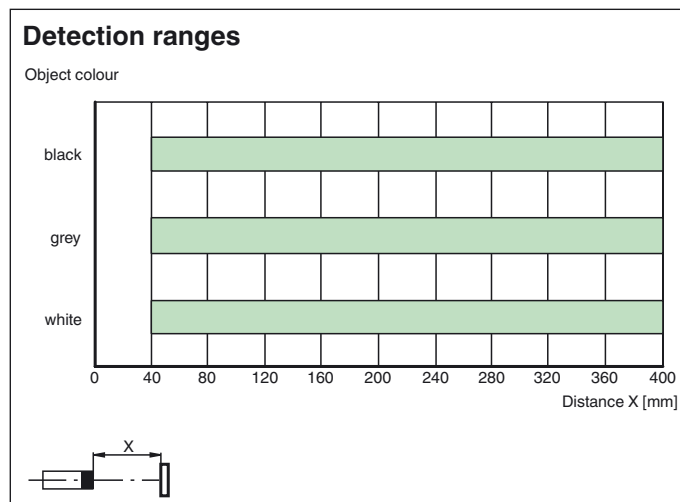
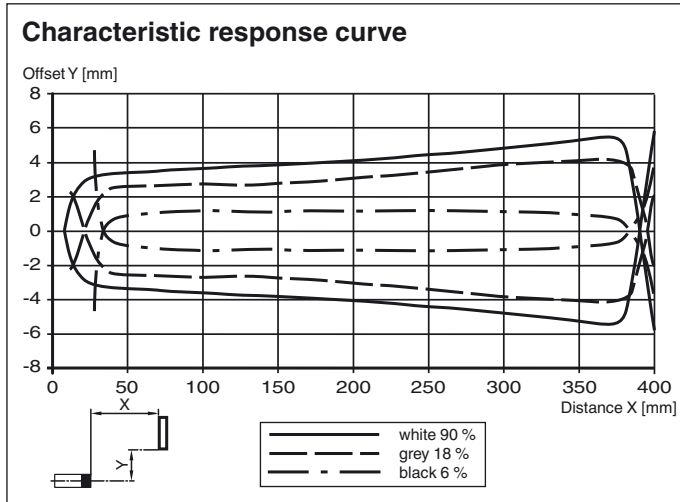

Settings

Teach-In (TI)

Use the rotary switch for switching signal **Q1** or **Q2** to select the relevant switching threshold A and/or B to teach in.

- The yellow LEDs indicate the current state of the selected output.

To teach in a switching threshold, press and hold the "TI" button for approximately 1 s, until the yellow and green LEDs flash in phase. Teach-in starts when the "TI" button is released.

- Teach-in successful: the yellow and green LEDs flash alternately at 2.5 Hz.
- Teach-in unsuccessful: the yellow and green LEDs quickly flash alternately at 8 Hz.

After an unsuccessful Teach-in, the sensor continues to operate with the previous valid setting after the relevant visual fault signal is issued.

Set switching mode: you can define different switching modes by teaching in the relevant distance data for switching thresholds A and B.

1. Single point mode:

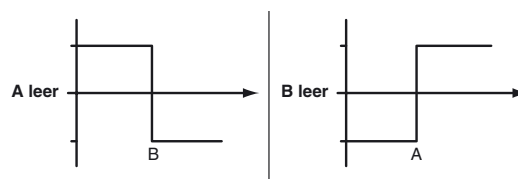

Release date: 2018-07-27 10:13 Date of issue: 2018-07-27 295670-100166_eng.xml

2. Window mode:

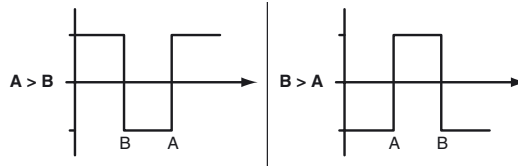

Teach in switching thresholds: you can teach in or overwrite a taught-in switching threshold at any time. To do this, press the "TI" button again.
 Reset a value: you can reset a taught-in value. To do this, press the "TI" button for > 4 s, until the yellow and green LEDs go out. The reset process itself starts when the "TI" button is released.

- Reset successful: the yellow and green LEDs flash alternately at 2.5 Hz.

Resetting to Factory Settings

To revert back to factory settings, press the "TI" button for > 10 s with the rotary switch set to position "O," until the yellow and green LEDs go out at the same time. The reset process itself starts when the "TI" button is released.

- Reset to factory settings successful: the yellow and green LEDs light up at the same time. The sensor then continues to operate with factory settings.

OQT

- Factory setting for switching signal Q1: Switching signal high active, BGS mode (background suppression)
- Factory setting for switching signal Q2: Switching signal high active, BGS mode (background suppression)

Configuration via IO-Link interface

Configuring different operating modes via the IO-Link interface

The devices are equipped with an IO-Link interface as standard for diagnostics and parameterization tasks to ensure optimum adjustment of the sensors to the relevant application. Four different operating modes can be set, among other features:

Background suppression operating mode (one switch point):

- Detection of objects irrespective of type and color in a defined detection range. Objects in the background are suppressed.



Background evaluation operating mode (one switch point):

- Detection of objects irrespective of type and color against a defined background. Reliable detection of objects at close range (detection range >= 0 mm). The background serves as reference.



Single point mode operating mode (one switch point):

- Detection of objects irrespective of type and color in a defined detection range. Objects in the background are suppressed.
- The switch point corresponds exactly to the set point.



Window mode operating mode (two switch points):

- Detection of objects irrespective of type and color in a defined detection range. Reliable detection when object leaves the detection range.
- Window mode with two switch points.



Center window mode operating mode (one switch point):

- Detection of objects irrespective of type and color in a defined detection range. Sets a defined window around a given object. Objects outside this window are not detected.
- Window mode with one switch point.

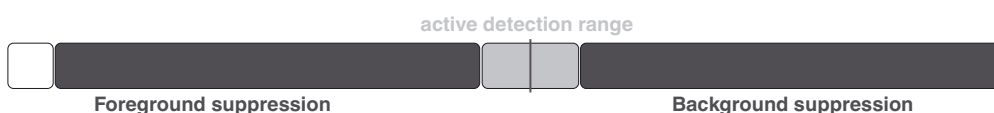

Two point mode operating mode (hysteresis operating mode):

- Detection of objects irrespective of type and color between a defined switch-on and switch-off point.

Release date: 2018-07-27 10:13 Date of issue: 2018-07-27 295670-100166_eng.xml

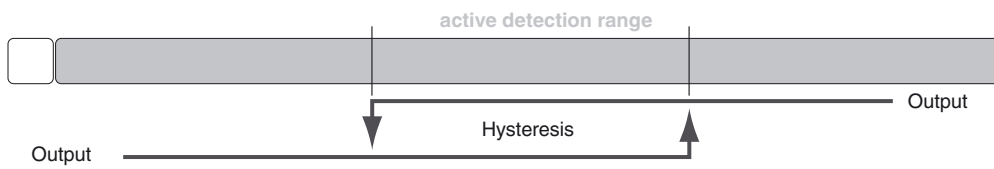
**Inactive operating mode:**

- Evaluation of switching signals is deactivated.

The associated IODD device description file can be found in the download area at www.pepperl-fuchs.com.