



**Model Number**

**OMT550-R201-2EP-IO-0,3M-V31**

Distance sensor  
with fixed cable and 4-pin, M8 connector

**Features**

- Medium design with versatile mounting options
- Space-saving distance sensors in small standardized design
- Multi Pixel Technology (MPT) - exact and precise signal evaluation
- IO-link interface for service and process data

**Product information**

The optical sensors in the series are the first devices to offer an end-to-end solution in a medium-sized standard design—from the thru-beam sensor through to the measuring distance sensor. As a result of this design, the sensors are able to perform practically all standard automation tasks.

The entire series enables sensors to communicate via IO-Link.

The DuraBeam laser sensors are durable and can be used in the same way as a standard sensor.

Multi Pixel Technology (MPT) ensures that the standard sensors are flexible and can be adapted to the application environment.

**Dimensions**

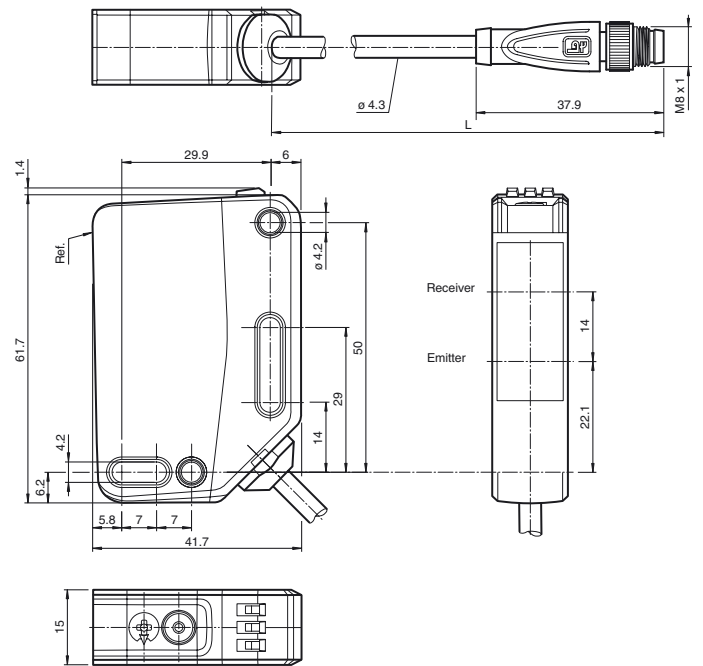

**Electrical connection**

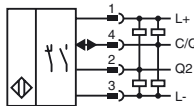

**Pinout**

Wire colors in accordance with EN 60947-5-2



- 1 | BN (brown)
- 2 | WH (white)
- 3 | BU (blue)
- 4 | BK (black)

**Indicators/operating means**

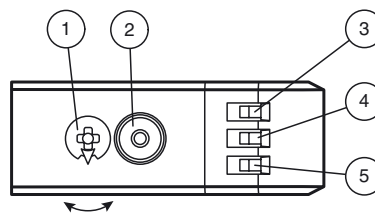

|   |                             |    |
|---|-----------------------------|----|
| 1 | Mode rotary switch          |    |
| 2 | Teach-in button             |    |
| 3 | Switching output display Q2 | YE |
| 4 | Switching output display Q1 | YE |
| 5 | Operating indicator         | GN |

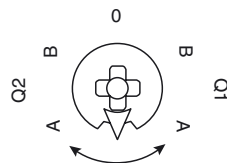

|     |                                   |
|-----|-----------------------------------|
| Q1B | Switching output 1/switch point B |
| Q1A | Switching output 1/switch point A |
| Q2A | Switching output 2/switch point A |
| Q2B | Switching output 2/switch point B |
| 0   | Keylock                           |

Release date: 2018-07-27 10:12 Date of issue: 2018-09-10 295670-100175\_eng.xml

Refer to "General Notes Relating to Pepperl+Fuchs Product Information".

**Technical data****General specifications**

|                            |                                       |
|----------------------------|---------------------------------------|
| Measurement range          | 100 ... 550 mm                        |
| Reference target           | standard white, 100 mm x 100 mm       |
| Light source               | LED                                   |
| Light type                 | modulated visible red light           |
| LED risk group labelling   | exempt group                          |
| Angle deviation            | max. +/- 1.5 °                        |
| Diameter of the light spot | approx. 20 mm at a distance of 550 mm |
| Angle of divergence        | 2.5 °                                 |
| Ambient light limit        | EN 60947-5-2 : 45000 Lux              |
| Resolution                 | 0.1 mm                                |

**Functional safety related parameters**

|                                |       |
|--------------------------------|-------|
| MTTF <sub>d</sub>              | 600 a |
| Mission Time (T <sub>M</sub> ) | 20 a  |
| Diagnostic Coverage (DC)       | 0 %   |

**Indicators/operating means**

|                     |   |
|---------------------|---|
| Operation indicator | LED green:<br>constantly on - power on<br>flashing (4Hz) - short circuit<br>flashing with short break (1 Hz) - IO-Link mode |
| Function indicator  | LED yellow:<br>constantly on - switch output active<br>constantly off - switch output inactive                              |
| Control elements    | Teach-In key  |
| Control elements    | 5-step rotary switch for operating modes selection  |

**Electrical specifications**

|                        |                |                                |
|------------------------|----------------|--------------------------------|
| Operating voltage      | U <sub>B</sub> | 10 ... 30 V DC                 |
| Ripple                 |                | max. 10 %                      |
| No-load supply current | I <sub>0</sub> | < 25 mA at 24 V supply voltage |
| Protection class       |                | III                            |

**Interface**

|                             |  |
|-----------------------------|--|
| Interface type              | IO-Link ( via C/Q = pin 4 )                                  |
| Device profile              | Identification and diagnosis<br>Smart Sensor type 0/type 3.3 |
| Transfer rate               | COM 2 (38.4 kBaud)   |
| IO-Link Revision            | 1.1  |
| Min. cycle time             | 3 ms   |
| Process data width          | Process data input 4 byte<br>Process data output 2 bits      |
| SIO mode support            | yes  |
| Device ID                   | 0x111911 (1120529)   |
| Compatible master port type | A  |

**Output**

|                   |   |            |
|-------------------|---|------------|
| Switching type    | The default setting is:<br>C/Q - Pin4: NPN normally open, PNP normally closed, IO-Link<br>Q2 - Pin2: NPN normally open, PNP normally closed |            |
| Signal output     | 2 push-pull (4 in 1) outputs, short-circuit protected, reverse<br>polarity protected, overvoltage protected                                 |            |
| Switching voltage | max. 30 V DC  |            |
| Switching current | max. 100 mA , resistive load  |            |
| Usage category    | DC-12 and DC-13   |            |
| Voltage drop      | U <sub>d</sub>  | ≤ 1.5 V DC |
| Response time     | 2 ms , see table 1  |            |

**Conformity**

|                         |              |
|-------------------------|--------------|
| Communication interface | IEC 61131-9  |
| Product standard        | EN 60947-5-2 |

**Measurement accuracy**

|                   |                     |
|-------------------|---------------------|
| Temperature drift | 0.05 %/K            |
| Warm up time      | 5 min               |
| Repeat accuracy   | ≤ 1 % , see table 1 |
| Linearity error   | 0.75 %              |

**Ambient conditions**

|                     |                                |
|---------------------|--------------------------------|
| Ambient temperature | 10 ... 60 °C (50 ... 140 °F)   |
| Storage temperature | -40 ... 70 °C (-40 ... 158 °F) |

**Mechanical specifications**

|                      |  |
|----------------------|--|
| Housing width        | 15 mm  |
| Housing height       | 61.7 mm  |
| Housing depth        | 41.7 mm  |
| Degree of protection | IP67 / IP69 / IP69K                                  |
| Connection           | fixed cable 300 mm with M8 x 1 male connector; 4-pin |
| Material             |  |
| Housing              | PC (Polycarbonate)                                   |
| Optical face         | PMMA   |
| Mass                 | approx. 41 g   |

**Accessories****IO-Link-Master02-USB**

IO-Link master, supply via USB port or separate power supply, LED indicators, M12 plug for sensor connection

**V31-WM-2M-PUR**

Female cordset, M8, 4-pin, PUR cable

**V31-GM-2M-PUR**

Female cordset, M8, 4-pin, PUR cable

Other suitable accessories can be found at [www.pepperl-fuchs.com](http://www.pepperl-fuchs.com)

Cable length 0.3 m

#### Approvals and certificates

UL approval E87056 , cULus Listed , class 2 power supply , type rating 1  
 CCC approval CCC approval / marking not required for products rated  $\leq 36$  V

**Table 1: Information on Measured Value Filters**

| Measured value filter |       |       |       |        |        |         |
|-----------------------|-------|-------|-------|--------|--------|---------|
| Filter                | 1-way | 2-way | 4-way | 16-way | 64-way | 256-way |
| Response time (ms)    | 2     | 4     | 8     | 32     | 128    | 512     |
| Repeatability (%)     | < 1 % |       |       |        |        |         |

## Settings

### Teach-In (TI)

Use the rotary switch for switching signal **Q1** or **Q2** to select the relevant switching threshold A and/or B to teach in.

- The yellow LEDs indicate the current state of the selected output.

To teach in a switching threshold, press and hold the "TI" button for approximately 1 s, until the yellow and green LEDs flash in phase. Teach-in starts when the "TI" button is released.

- Teach-in successful: the yellow and green LEDs flash alternately at 2.5 Hz.
- Teach-in unsuccessful: the yellow and green LEDs quickly flash alternately at 8 Hz.

After an unsuccessful Teach-in, the sensor continues to operate with the previous valid setting after the relevant visual fault signal is issued.

Set switching mode: you can define different switching modes by teaching in the relevant distance data for switching thresholds A and B.

#### 1. Single point mode:

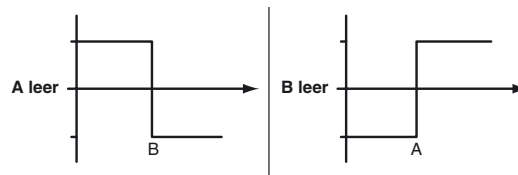

#### 2. Window mode:

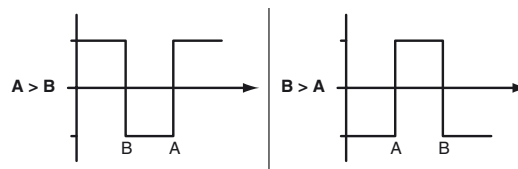

Teach in switching thresholds: you can teach in or overwrite a taught-in switching threshold at any time. To do this, press the "TI" button again.

Reset a value: you can reset a taught-in value. To do this, press the "TI" button for > 4 s, until the yellow and green LEDs go out. The reset process itself starts when the "TI" button is released.

- Reset successful: the yellow and green LEDs flash alternately at 2.5 Hz.

### Resetting to Factory Settings

To revert back to factory settings, press the "TI" button for > 10 s with the rotary switch set to position "O," until the yellow and green LEDs go out at the same time. The reset process itself starts when the "TI" button is released.

- Reset to factory settings successful: the yellow and green LEDs light up at the same time. The sensor then continues to operate with factory settings.

#### OMT

- Factory setting for switching signal Q1:  
Switching signal is high active, window mode
- Factory setting for switching signal Q2:  
Switching signal is high active, window mode

## Configuration via IO-Link interface

### Setting different operating modes via the IO-Link interface

The devices are equipped with an IO-Link interface as standard for diagnostics and parameterization tasks to ensure optimum adjustment of the sensors to the relevant application.

#### Single point mode operating mode (one switch point):

- "Detection of objects irrespective of type and color in a defined detection range. Objects in the background are suppressed.
- "The switch point corresponds exactly to the set point.



#### Window mode operating mode (two switch points):

- Detection of objects irrespective of type and color in a defined detection range. Reliable detection when object leaves the detection range.
- Window mode with two switch points.



#### Center window mode operating mode (one switch point):

- Detection of objects irrespective of type and color in a defined detection range. Sets a defined window around a given object. Objects outside this window are not detected.
- Window mode with one switch point.



#### Two point mode operating mode (hysteresis operating mode):

- Detection of objects irrespective of type and color between a defined switch-on and switch-off point.

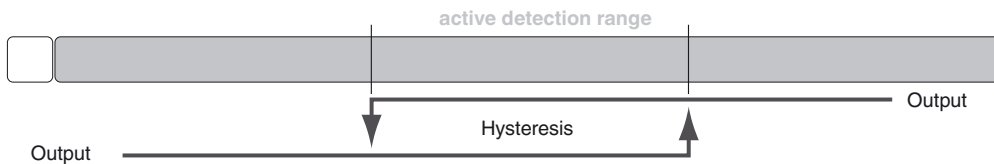

#### Inactive operating mode:

- Evaluation of switching signals is deactivated.

The associated IODD device description file can be found in the download area at [www.pepperl-fuchs.com](http://www.pepperl-fuchs.com).