



Model number

ICE1-16DIO-G60L-V1D

Ethernet IO module with 16 configurable digital inputs/outputs

Features

- Multiprotocol-compatible
- M12 power connector
- Sturdy metallic housing
- Web-based configuration
- 16 digital inputs/outputs can be configured

Function

The ICE1-16DIO-G60L-V1D is a multiprotocol fieldbus module with 16 digital in- or outputs. The G60L design in fully cast metal housing is resistant to mechanical damage and environmental influences. The G60L has protection class IP65/IP67.

The fieldbus module serves as an interface between the controller of a fieldbus system and the field level. Thanks to its multiprotocol capability, the fieldbus module supports the Ethernet communication protocols PROFIBUS, EtherNet/IP, and EtherCAT.

An L-coded M12 connector plug used for supplying power enables a current rating of up to 16 A. The inputs are equipped with A-coded M12 connector plugs. Connection to the fieldbus is achieved using a D-coded M12 connector plug.

The communication protocols are configured either manually via a rotary switch or automatically. The diagnostics display status information for each channel via LEDs. An integrated web server enables access to the fieldbus module. Information regarding the status of the module is also displayed and network parameters such as the IP address and subnet mask can be configured.

Dimensions

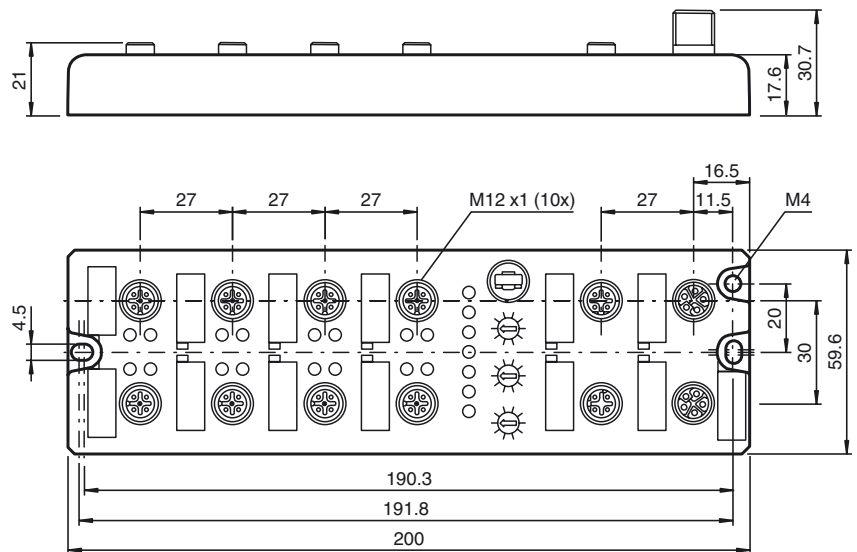

Electrical connection

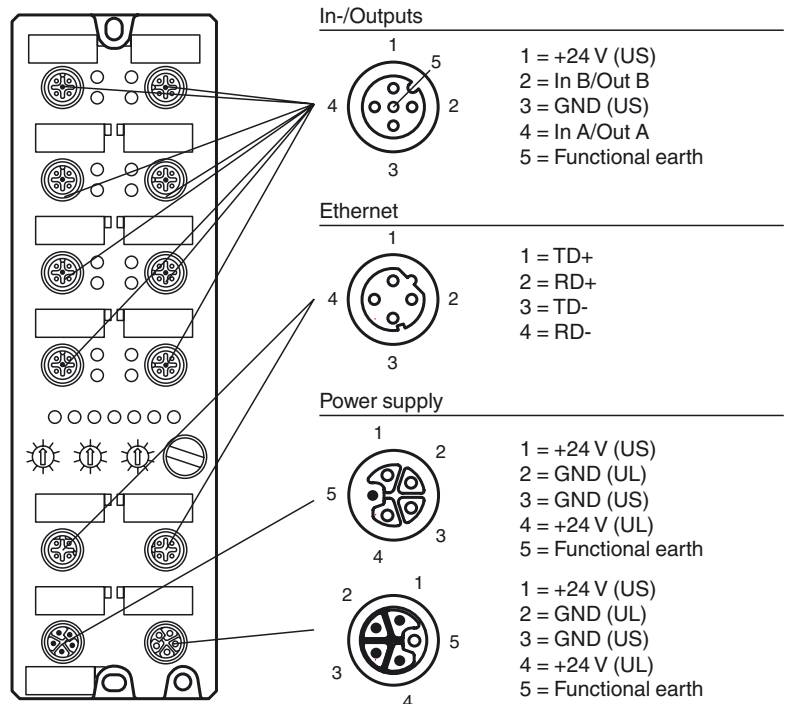

Release date: 2018-12-19 15:33 Date of issue: 2018-12-19 308626_eng.xml

Indicating / Operating means

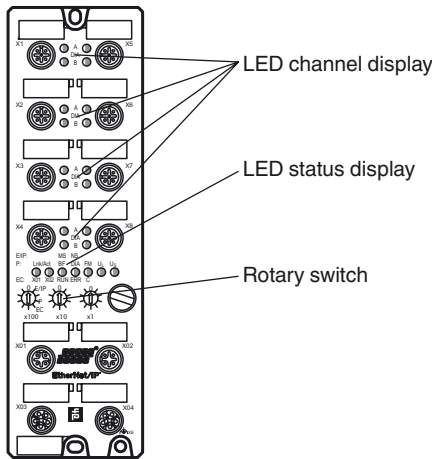

Technical data

General specifications

UL File Number E223772

Indicators/operating means

LED indication see manual
 Rotary switch Setting the fieldbus protocol

Electrical specifications

Rated operating voltage U_e 18 ... 30 V
 Nominal voltage 24 V DC
 Nominal current 16 A
 Current consumption 120 mA
 Current loading capacity max. 16 A per module (for UL applications, max. 9 A)

Interface 1

Interface type Industrial Ethernet
 Physical M12, D-coded
 Protocol PROFINET IO with media redundancy protocol (MRP)
 EtherNet/IP with Device Level Ring (DLR)
 EtherCAT
 Transfer rate 10/100 Mbps

Inputs/Outputs

Number/Type 16 digital inputs/outputs, configurable
 Inputs: 2-, 3-, 4-wire PNP, DC, supply from U_S
 Outputs: 2-wire PNP, DC, supply from U_L
 No galvanic isolation between U_S and U_L
 short-circuit protected
 Sensor supply max. 500 mA Per port (X1 - X8)
 Output rated operating current I_e max. 2 A per channel (X1 - X8) / 4 A Per port

Directive conformity

Electromagnetic compatibility
 Directive 2014/30/EU EN 61000-6-2:2005, EN 61000-6-4:2007+A1:2011

Standard conformity

Degree of protection EN 60529:2000
 Emitted interference EN 61000-6-4:2007+A1:2011
 Noise immunity EN 61000-6-2:2005

Ambient conditions

Ambient temperature -20 ... 70 °C (-4 ... 158 °F)
 Storage temperature -25 ... 85 °C (-13 ... 185 °F)
 Cold start temperature -40 °C (-40 °F)
 Relative humidity max. 95 %
 Altitude 0 ... 2000 m
 Shock and impact resistance 50 g, 11 ms, all axes
 Vibration resistance 15 g at 5 - 500 Hz
 Pollution degree 3

Mechanical specifications

Contact elements PA
 Degree of protection IP65/IP67/IP69K
 Connection Power Supply M12, L-coded
 Fieldbus M12, D-coded
 Inputs M12, A-coded
 Material
 Contacts CuSn, gold-plated
 CuNi, gold-plated
 Housing Diecast zinc
 Seal FKM

Accessories

V15L-G-5M-PUR-U

Single-ended female cordset, M12, L-coded, 5-pin, PUR cable

V15L-G-0,6M-PUR-U-V15L-G

Cordset, M12 to M12, L-coded, 5-pin, PUR cable

V15L-G-1M-PUR-U-V15L-G

Cordset, M12 to M12, L-coded, 5-pin, PUR cable

V15L-G-2M-PUR-U-V15L-G

Cordset, M12 to M12, L-coded, 5-pin, PUR cable

V1SD-G-2M-PUR-ABG-V45-G

Connection cable, M12 to RJ-45, PUR cable 4-pin, CAT5e

V1SD-G-2M-PUR-ABG-V1SD-G

Ethernet bus cable, M12 to M12, PUR cable 4-pin, CAT5e

V1SD-G-ABG-PG9

Cable connector, M12, 4-pin, D-coded, shielded, non pre-wired

V1-G-BK1M-PUR-A-T-V1-G

Y connecting cable, M12 to 2xM12, 4-pin, PUR cable

V1S-T-V1

Y-splitter, M12 connector on M12 socket/socket

VAZ-V1-B3

Blind plug for M12 sockets

V15L-G-BK

Single-ended female cordset, M12, L-coded, field attachable

MH V1-SCREWDRIVER

torque screwdriver (0.6 Nm)

MH V1-BIT M12

plug-in cap M12

Mass	500 g
Tightening torque, fastening screws	1 Nm
Tightening torque, cable gland	≤ 0.5 Nm
Construction type	Field housing
Tightening torque of clamping screws	0.5 Nm

Release date: 2018-12-19 15:33 Date of issue: 2018-12-19 308626_eng.xml

Refer to "General Notes Relating to Pepperl+Fuchs Product Information".

Pepperl+Fuchs Group
www.pepperl-fuchs.com

USA: +1 330 486 0001
fa-info@us.pepperl-fuchs.com

Germany: +49 621 776 4411
fa-info@de.pepperl-fuchs.com

Singapore: +65 6779 9091
fa-info@sg.pepperl-fuchs.com