



Model Number

LT2-8-HS-6000/49/105

Active infrared scanner
with 5-pin, M12 x 1 plastic connector

Features

- Mode selectable: background suppression or evaluation
- Mechanical adjustable detection range
- Adjustable timer functions
- DC voltage version
- Version with test input

Product information

Diffuse mode sensors LT(K)2 are used when people, objects, or vehicles are to be detected in a precisely defined area. The devices are extremely sturdy and resistant to mechanical strain. In background evaluation operating mode, the sensors can be used with any background. In background suppression operating mode, the background serves as a reference area. This enables highly reflective objects to be reliably detected as well. In addition, this operating mode offers an option for testing.

Release date: 2013-06-25 16:45 Date of issue: 2016-08-16 419306_eng.xml

Dimensions

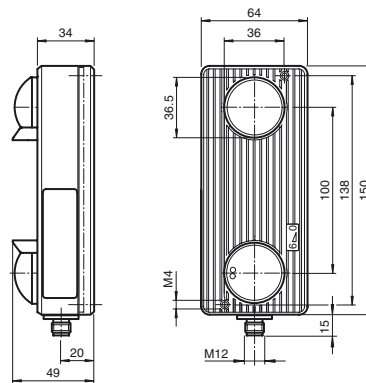

Electrical connection

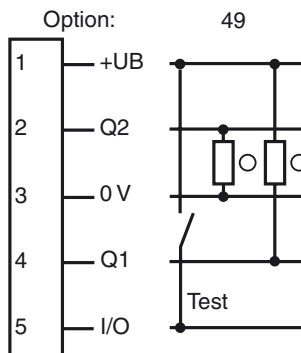

- = Light on
- = Dark on

Pinout

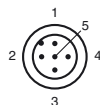

Wire colors in accordance with EN 60947-5-2

1	BN	(brown)
2	WH	(white)
3	BU	(blue)
4	BK	(black)
5	GY	(gray)

Indicators/operating means

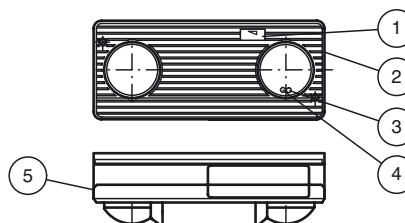

1	Detection range indicator	
2	Detection range adjuster	
3	Operation display	Green
4	Function display	Yellow
5	Programming switch under cover	

Technical data

General specifications

Detection range min.	0 ... 500 mm by background evaluation, 350 ... 500 mm by background suppression
Detection range max.	0 ... 6000 mm by background evaluation, 200 ... 6000 mm by background suppression
Light source	IREL
Light type	modulated infrared light
Operating mode	switching between background suppression/evaluation
Diameter of the light spot	150 mm at 6000 mm sensor range

Functional safety related parameters

MTTF _d	730 a
Mission Time (T _M)	20 a
Diagnostic Coverage (DC)	60 %

Indicators/operating means

Function indicator	LED green: power on LED yellow: object detection
Control elements	Sensing range setting, programming switch for time functions, time setting

Electrical specifications

Operating voltage	U _B	15 ... 35 V DC
Ripple		10 %
No-load supply current	I ₀	100 mA

Input

Test input	emitter deactivation with +U _B
------------	---

Output

Switching type	light/dark on selectable programmable, Factory setting: light on
Signal output	1 NPN, 1 PNP, short-circuit protected, open collectors
Switching voltage	35 V DC
Switching current	200 mA
Response time	100 ms
De-energized delay	t _{off} 400 ms
Timer function	Programmable on/off delay, adjustable 0.1 ... 10 s

Ambient conditions

Ambient temperature	-20 ... 60 °C (-4 ... 140 °F)
---------------------	-------------------------------

Mechanical specifications

Degree of protection	IP65
Connection	5-pin plastic M12 connector without cable
Material	
Housing	Makrolon GV30
Optical face	hardened plastic lens
Mass	320 g

Compliance with standards and directives

Directive conformity	EMC Directive 2004/108/EC
Standard conformity	
Product standard	EN 60947-5-2:2007 IEC 60947-5-2:2007
Emitted interference	EN 61000-6-3
Standards	EN 61000-6-2 without EN 61000-4-5, EN 61000-4-11

Approvals and certificates

CE conformity	yes
---------------	-----

Curves/Diagrams

Difference in detection distance (with background suppression)

Measured detection distance X [mm]

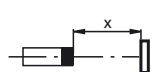
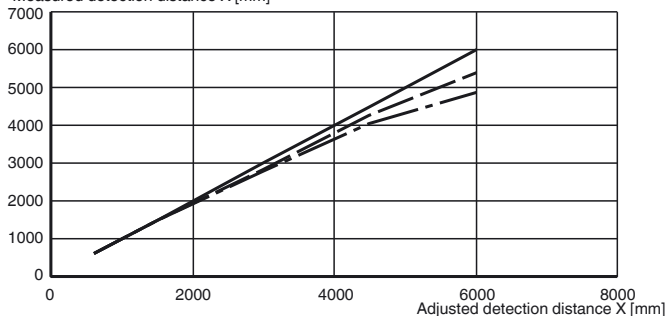

—	white 90 %
- - -	grey 18 %
· · ·	black 6 %

Typical applications

- Opening impulse sensor and protection mechanism for closing edges on automatic doors and industrial doors
- Opening impulse sensor for automatic doors
- Vehicle detection in traffic technology (e.g., individual parking space monitoring)
- Height measurement at entrances
- Anti-collision protection on automated guided systems

Detection area

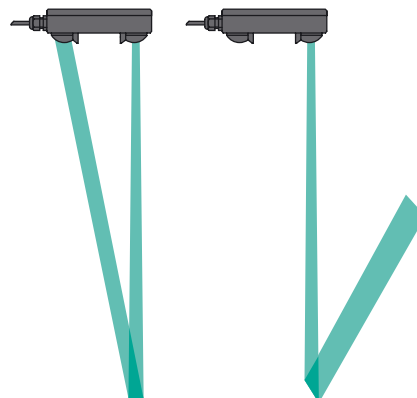

Accessories

Montageplatte LT

Mounting plate for sensors in the LT and FLT series

V15-G-2M-PUR

Female cordset, M12, 5-pin, PUR cable

Other suitable accessories can be found at www.pepperl-fuchs.com

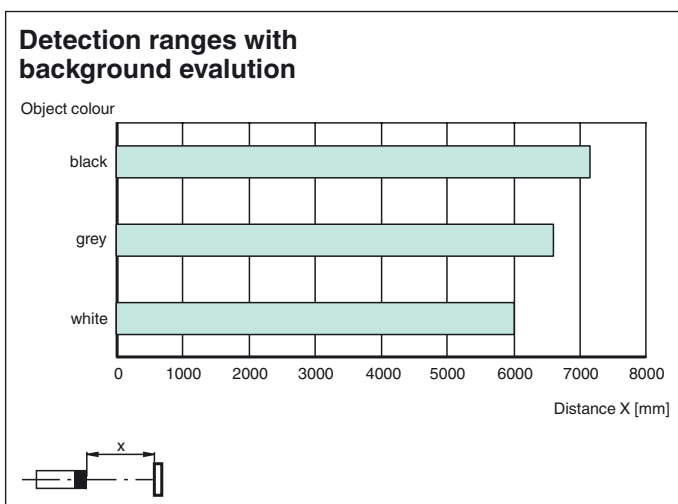
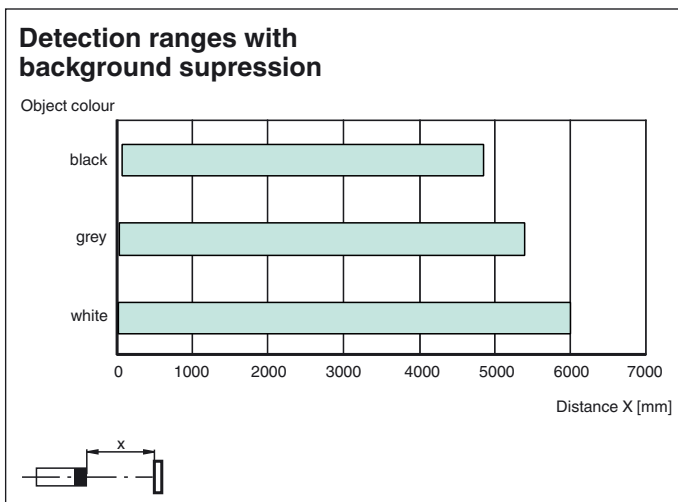
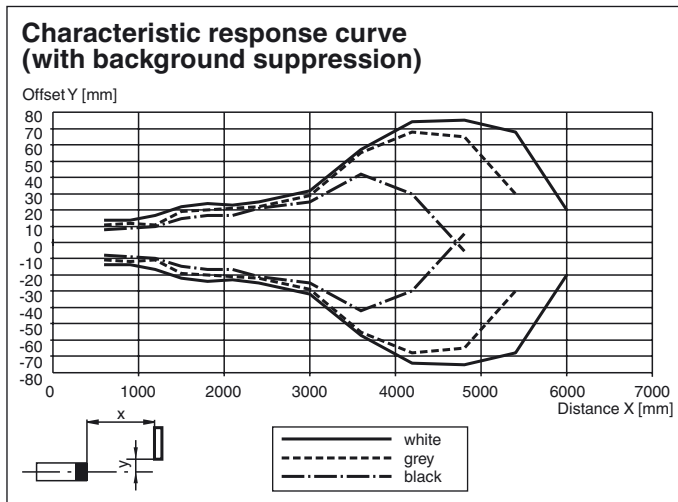

Functional principle

The active infrared scanners of the LT2 and LTK2 series function with the background suppression and background evaluation operating modes. The emitter and receiver are aligned at a certain angle in relation to one another. This angle can be changed and is used to determine the maximum detection range. The LT2 series operates with dc voltage and features transistor outputs; the LTK2 series operates with ac/dc voltage and features a relay output.

The devices are delivered with background suppression as the default mode.

Background Suppression Operating Mode

The sensor switches state when an object moves into or out of the detection range and is detected by the light beam. The background and/or base is ignored during this process. The sensitivity of the sensor can be adjusted so that objects beyond a certain distance are ignored. Sensors that feature this operating mode can be mounted for mobile use.

Background Evaluation Operating Mode

The sensor switches state when an object moves into or out of the detection range and is detected by the light beam. However, where background evaluation is used, some form of background (such as the floor or a wall) must be present as a point of reference.

The sensor continues to switch even if no light is received from the background. Sensors with background evaluation do not have foreground

suppression. This means that they can also detect objects directly in front of the lens (detection range = 0), making them particularly suited for detecting objects that are difficult to detect, especially highly reflective objects.

Additional information

Alignment/Setting Instructions

Always use the object with the lowest reflection value (darkest color) for alignment purposes.

1. Align the sensor to the target objects

Turn the detection range controller all the way to the right end stop (-)

(CAUTION! The controller is not protected from overturning—handle with care)

Turn the detection range controller to the left (+) until the yellow LED starts to light up

2. Remove the target objects; the LED goes out (note background influences).

If the background (floor, wall) is permanently or occasionally reflective and shiny, due to moisture for example, the device must be installed in such a manner that it is rotated through $> 5^\circ$ along its longitudinal axis to prevent a mirror effect.

Selecting the appropriate operating mode

The devices are supplied in background suppression operating mode.

The background evaluation mode should be used if:

- Objects close to the optics are detected (detection range = 0 mm)
- Reflective, shiny objects must be detected (e.g. vehicles)
- A device function test is performed by means of test input

CAUTION! When in background evaluation operating mode, the sensor must always be aligned with a background that remains as constant as possible. Where this is not guaranteed, background suppression operating mode must be used. The background must be located within the stipulated maximum detection range.

Programming functions

The four programming functions are set using a DIP switch, which is located on the rear of the printed circuit board. To operate, simply remove the housing cover.

The functions described can be programmed as follows:

Switch	Description	ON	OFF
1	Operating mode	Background evaluation	Background suppression
2	Switching mode	Light on (L)	Dark on (D)
3	Timer function	ON delay (GAN)	-
4	Timer function	OFF delay (GAB)	-



Use the potentiometer to the left of the switches to set the GAN and GAB times steplessly from 0.1–10 s.