



Model Number

SU18-40a/102/115/126a

Fiber optic sensor
with fixed cable

Features

- Basic line for DIN rail installation
- Sleek design
- 3 response times selectable
- High switching frequency
- Self diagnosis function

Dimensions

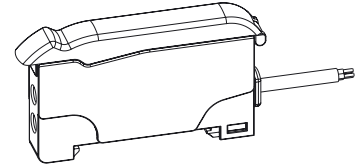
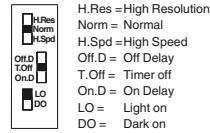
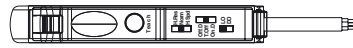
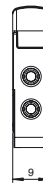
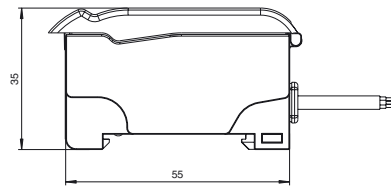

Electrical connection

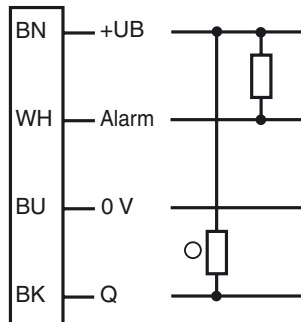

○ = Light on
● = Dark on

Release date: 2018-01-15 17:07 Date of issue: 2018-01-15 803587_eng.xml

Technical data**General specifications**

Sensor range	up to 150 mm (KLR-C02-2,2-2,0-K146)
Detection range	up to 450 mm (KLE-C01-2,2-2,0-K116)
Light source	LED
Light type	modulated visible red light , 660 nm
Ambient light limit	10000 Lux

Functional safety related parameters

MTTF _d	690 a
Mission Time (T _M)	20 a
Diagnostic Coverage (DC)	0 %

Indicators/operating means

Operation indicator	LED green, statically lit Power on , Undervoltage indicator: Green LED, pulsing (approx. 0.8 Hz) , short-circuit : LED green flashing (approx. 4 Hz)
Function indicator	LED yellow: static illumination switching state, flashes when falling short of the stability control
Control elements	Teach-In key slide switch 2 positions: light/dark switching slide switch 3 positions: timer function - timer off, on delay 40 ms, off-delay 40 ms slide switch 3 positions: operating mode - normal, high speed , high resolution

Electrical specifications

Operating voltage	U _B	10 ... 30 V DC
Ripple		10 %
No-load supply current	I ₀	≤ 30 mA

Output

Pre-fault indication output		1 NPN, short-circuit protected open collector
Switching type		light/dark on, switchable
Signal output		1 NPN, short-circuit protected open collector
Switching voltage		max. 30 V DC
Switching current		max. 100 mA , resistive load
Voltage drop	U _d	≤ 2 V DC at 100 mA ; ≤ 0.7 V at 10 mA
Switching frequency	f	Standard mode: 3 kHz , High speed mode: 6 kHz , High resolution: 500 Hz
Response time		Standard mode: 160 μs , High speed mode: 80 μs , High resolution: 1 ms
Repeat accuracy	R	≤ 0.5 % of adjusted sensor range

Ambient conditions

Ambient temperature	-10 ... 55 °C (14 ... 131 °F)
Storage temperature	-20 ... 70 °C (-4 ... 158 °F)

Mechanical specifications

Housing width	9 mm
Housing height	34.5 mm
Housing depth	62.3 mm
Degree of protection	IP50
Connection	2 m PVC cable, 4 x 0,14 mm ²
Material	
Housing	PC
Mass	45 g

Compliance with standards and directives

Standard conformity	
Product standard	EN 60947-5-2:2007 IEC 60947-5-2:2007

Approvals and certificates

UL approval	cULus Listed, Class 2 Power Source, Type 1 enclosure
CCC approval	CCC approval / marking not required for products rated ≤36 V

Accessories**HPF-D032**

KLR-C02-2,2-2,0-K146
Plastic fiber optic - diffuse

KLR-C02-2,2-2,0-K70
Plastic fiber optic - diffuse

KLR-C02-1,0-2,0-K75
Plastic fiber optic - diffuse

KLR-C09-1,25-2,0-K76
Plastic fiber optic - diffuse

KLR-C09-1,25-2,0-K74
Plastic fiber optic - diffuse

KLR-C16-2,2-2,0-K71
Plastic fiber optic - diffuse

KLR-A32-2,2-2,0-K83
Plastic fiber optic - diffuse

KHR-C02-2,2-2,0-K131
Plastic fiber optic - diffuse

KHTR-C02-2,2-2,0-K88
Plastic fiber optic - diffuse

LHR 00-0,8-1,0-20M4
Glass fiber optic - diffuse with silicon covering

KLE-C01-2,2-2,0-K116
Plastic fiber optic - thru-beam

KLE-C01-2,2-2,0-K103
Plastic fiber optic - thru-beam

KLE-C01-2,2-2,0-K102
Plastic fiber optic - thru-beam

KLE-C01-2,2-2,0-K100
Plastic fiber optic - thru-beam

KLE-C01-2,2-2,0-K101
Plastic fiber optic - thru-beam

KLE-C01-2,2-2,0-K113
Plastic fiber optic - thru-beam

KLE-C01-1,0-2,0-K120
Plastic fiber optic - thru-beam

KHE-C01-2,2-2,0-K122
Plastic fiber optic - thru-beam

KHTE-C01-2,2-2,0-K118
Plastic fiber optic - thru-beam

LHE 00-1,1-1,0-20M4
Glass fiber optic - thru-beam with silicon covering

Bracket SU
Mounting bracket for DIN rail

Other suitable accessories can be found at
www.pepperl-fuchs.com

Curves/Diagrams

Self-Diagnostic definition and operation:

5 sec. rule for light-ON (LO) and dark-ON (DO) mode

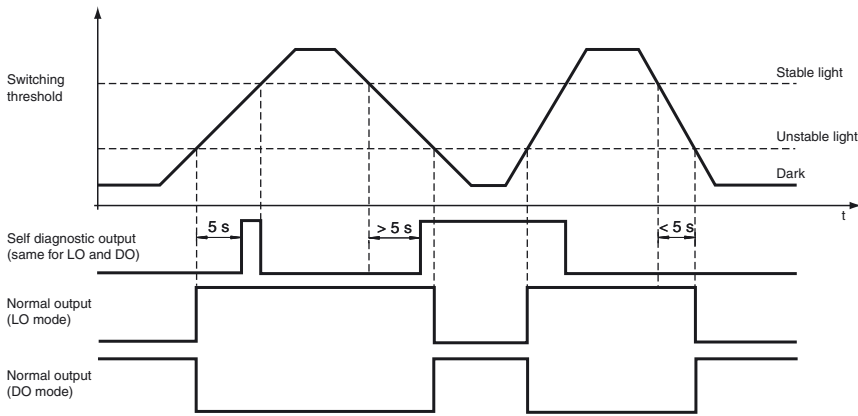

8 cyc. rule for light-ON (LO) and dark-ON (DO) mode

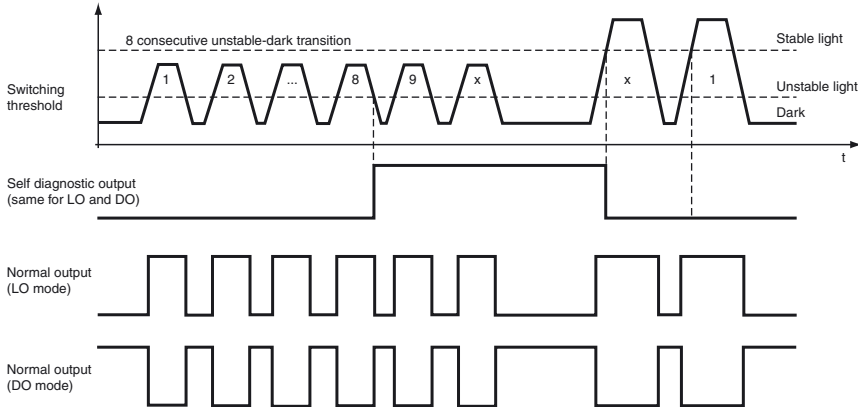

LED indicators and operating chart:

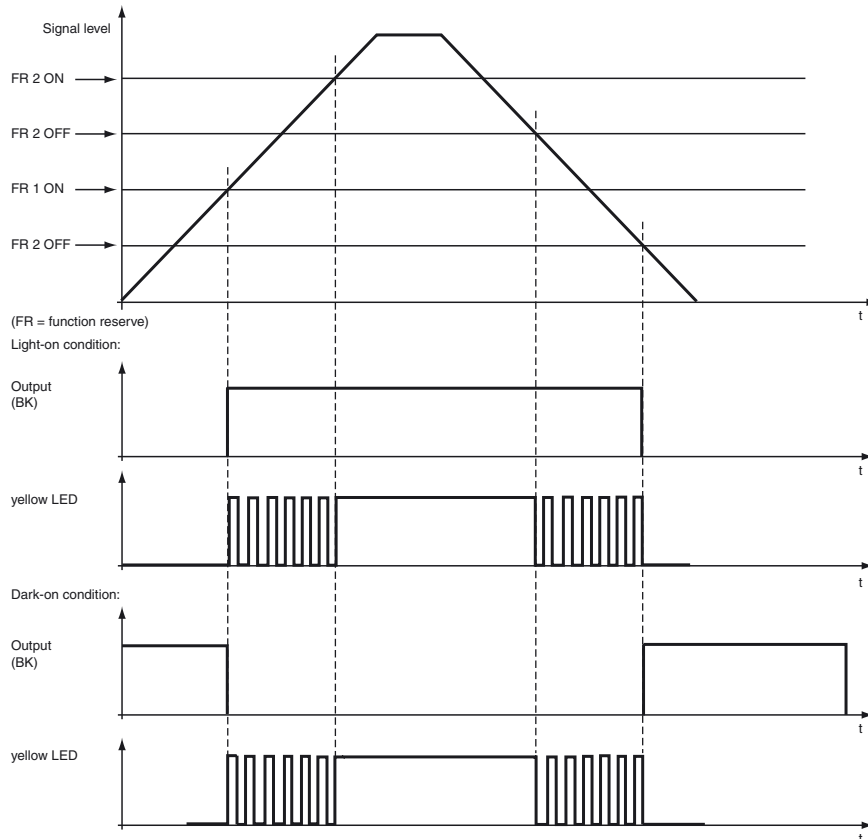

Release date: 2018-01-15 17:07 Date of issue: 2018-01-15 803587_eng.xml

Refer to "General Notes Relating to Pepperl+Fuchs Product Information".

Pepperl+Fuchs Group
www.pepperl-fuchs.com

USA: +1 330 486 0001
fa-info@us.pepperl-fuchs.com

Germany: +49 621 776 4411
fa-info@de.pepperl-fuchs.com

Singapore: +65 6779 9091
fa-info@sg.pepperl-fuchs.com

Teach-in procedures

(for Auto Teach version only):

Dynamic Teach in High Resolution mode:

1. Place a target
2. Press and hold the Teach button for > 2 seconds to enter Teach mode. Both LEDs will indicate fast inphase blinking follow by slow in-phase blinking. If the target is too near (strong signal), the fast blinking will last slightly longer follow by slow blinking
3. Remove target or move target further away from sensor
4. Press and hold the Teach button for < 2 seconds to end Teach mode. Both LEDs will indicate fast inphase blinking and then alternate blinking to signal end of Teach mode

Dynamic Teach in Normal mode:

1. Press and hold the Teach button for > 2 seconds to enter Teach mode. Both LEDs will indicate fast inphase blinking follow by slow in-phase blinking
2. Pass a moving target
3. Press and hold the Teach button for < 2 seconds to end Teach mode. Both LEDs will indicate alternate blinking to signal end of Teach mode

Maximum Teach:

1. Remove target
2. Press and hold the Teach button for > 2 seconds to enter Teach mode. Both LEDs will indicate fast inphase blinking follow by slow in-phase blinking
3. Press and hold the Teach button for > 2 seconds to end Teach mode. Both LEDs will indicate fast inphase blinking and then alternate blinking to signal end of Teach mode

Position Teach:

1. Place a target
2. Press and hold the Teach button for > 2 second to enter Teach mode. Both LEDs will indicate fast inphase blinking follow by slow in-phase blinking. If the target is too near (strong signal), the fast blinking will last slightly longer follow by slow blinking
3. Press and hold the Teach button for > 2 seconds to end Teach mode. Both LEDs will indicate fast inphase blinking and then alternate blinking to signal end of Teach mode

Indications for the Green and Yellow LEDs in detection mode (normal operation):

- Yellow LED is stable ON to indicate that signal received is > FR2
- Yellow LED will flash at 4 Hz to indicate function reserve, FR1 < signal level < FR2
- Green LED stable ON to indicate power supply is ON, sensor is ready.
- Green LED will flash once for each key actuation, e.g. actuation of the Teach button
- Green LED will flash at 4 Hz to indicate a short-circuit fault at the output(s)
- Green LED will flash at 0.8 Hz to indicate an under voltage fault at the power supply

Indications for the Green and Yellow LEDs in the Teach Mode:

- Yellow & Green LEDs in-phase blinking indicates that the sensor has entered the Teach Mode
- Slow Yellow & Green LEDs in-phase blinking indicates that the sensor is ready or it is waiting to learn new information about the target and/or the background
- Fast Yellow & Green LEDs in-phase blinking means that the sensor is in the progress of learning new target. When the learning is complete, slow in-phase blinking will be resumed as before
- Green & Yellow LEDs flash alternately at 8 Hz indicates there has been a Teach fault or Teach error

Selection table - thru-beam fiber optic cable

Head shape	Moun-ting	Model number	Core	Detection distance	Fiber cross section	minimum Object size	Fiber optic length	Bend radius	Dimensions	Special features
Highly precise										
Threaded	M3	KLE-C01-1.0-2.0-K120	PMMA	20 mm	0.25 mm	0.05 mm	2 m	min. 10 mm		
Threaded	M4	KLE-C01-1.0-2.0-K119	PMMA	20 mm	0.25 mm	0.05 mm	2 m	min. 10 mm		4 x high Detection range with Auxiliary lens K-LA01/ 8 x high Detection range with Auxiliary lens K-LA06/ Side view / Periscope with K-LA02
Threaded	M3 x 0.5	KLE-C04-1.0-2.0-K104	PMMA	70 mm	4 x 0.25 mm	0.12 mm	2 m	min. 15 mm		

Release date: 2018-01-15 17:07 Date of issue: 2018-01-15 803587_eng.xml

Head shape	Moun-ting	Model number	Core	Detection distance	Fiber cross section	minimum Object size	Fiber optic length	Bend radius	Dimensions	Special features
Cylindrical	dia. 2 mm	KLE-C01-1.0-2.0-K105	PMMA	20 mm	0.25 mm	0.05 mm	2 m	min. 10 mm		
Cylindrical	dia. 1.5 mm	KLE-C01-1.0-2.0-K107	PMMA	20 mm	0.25 mm	0.05 mm	2 m	min. 10 mm		
Cylindrical	dia. 1.5 mm	KLE-C04-1.0-2.0-K108	PMMA	70 mm	4 x 0.25 mm	0.12 mm	2 m	min. 15 mm		
Cylindrical	dia. 2 mm	KLE-C04-1.0-2.0-K106	PMMA	70 mm	4 x 0.25 mm	0.05 mm	2 m	min. 15 mm		
Highly flexible										
Threaded	M3	KHE-C01-1.0-2.0-K125	PMMA	50 mm	0.5 mm	0.15 mm	2 m	min. 1 mm		only 1 mm Bend radius
Threaded	M3	KHE-C01-2.2-2.0-K122	PMMA	200 mm	1 mm	0.25 mm	2 m	min. 2 mm		only 2 mm Bend radius
Threaded	M4 x 0.7 / M2.6	KHE-C01-1.0-2.0-K124	PMMA	50 mm	0.5 mm	0.15 mm	2 m	min. 1 mm		4 x high Detection range with Auxiliary lens K-LA01/ 8 x high Detection range with Auxiliary lens K-LA06 Side view / Periscope with K-LA02/ only 1 mm Bend radius
Threaded	M6	KHE-C01-2.2-2.0-K121	PMMA	200 mm	1.0 mm	0.25 mm	2 m	min. 2 mm		only 2 mm Bend radius
Cylindrical	dia. 1.5 mm	KHE-C01-1.0-2.0-K139	PMMA	50 mm	0.5 mm	0.05 mm	2 m	min. 1 mm		only 1 mm Bend radius
Cylindrical	dia. 3 mm	KHE-C01-2.2-2.0-K126	PMMA	50 mm	0.5 mm	0.15 mm	2 m	min. 1 mm		only 1 mm Bend radius
Cylindrical	dia. 3 mm	KHE-C01-2.2-2.0-K123	PMMA	200 mm	1 mm	0.25 mm	2 m	min. 2 mm		only 2 mm Bend radius

Release date: 2018-01-15 17:07 Date of issue: 2018-01-15 803587_eng.xml

Refer to "General Notes Relating to Pepperl+Fuchs Product Information".

Pepperl+Fuchs Group
www.pepperl-fuchs.com

USA: +1 330 486 0001
fa-info@us.pepperl-fuchs.com

Germany: +49 621 776 4411
fa-info@de.pepperl-fuchs.com

Singapore: +65 6779 9091
fa-info@sg.pepperl-fuchs.com

Head shape	Moun-ting	Model number	Core	Detection distance	Fiber cross section	minimum Object size	Fiber optic length	Bend radius	Dimensions	Special features
Right angle	dia. 15 x 5	KHE-C01-2.2-2.0-K137	PMMA	35 mm	0.5 mm	0.15 mm	2 m	min. 1 mm		only 1 mm Bend radius
Right angle	dia. 15 x 5	KHE-C01-2.2-2.0-K140	PMMA	150 mm	1 mm	0.25 mm	2 m	min. 2 mm		only 2 mm Bend radius
Flexible										
Threaded	M3 x 0.5 /M2.6	KLE-C01-1.3-2.0-K112	PMMA	200 mm	1 mm	0.25 mm	2 m	min. 25 mm		4 x high Detection range with Auxiliary lens K-LA01/ 8 x high Detection range with Auxiliary lens K-LA06 Side view / Periscope with K-LA02
Threaded	M3 x 0.5	KLE-C01-2.2-2.0-K103	PMMA	220 mm	1 mm	0.25 mm	2 m	min. 25 mm		
Threaded	M4 x 0.7 /M2.6	KLE-C01-2.2-2.0-K102	PMMA	220 mm	1 mm	0.25 mm	2 m	min. 25 mm		4 x high Detection range with Auxiliary lens K-LA01/ 8 x high Detection range with Auxiliary lens K-LA06 Side view / Periscope with K-LA02
Threaded	M6	KLE-C01-2.2-2.0-K100	PMMA	220 mm	1 mm	0.32 mm	2 m	min. 25 mm		
Threaded	M2.6	KLE-C01-2.2-2.0-K113	PMMA	200 mm	1 mm	0.25 mm	2 m	min. 25 mm		4 x high Detection range with Auxiliary lens K-LA01/ 8 x high Detection range with Auxiliary lens K-LA06 Side view / Periscope with K-LA02
Cylindrical	dia. 2 mm	KLE-C01-1.3-2.0-K114	PMMA	220 mm	1 mm	0.25 mm	2 m	min. 25 mm		
Cylindrical	dia. 5 mm	KLE-C01-2.2-2.0-K101	PMMA	220 mm	1 mm	0.32 mm	2 m	min. 25 mm		
Bendable tip										
Threaded	M4	KLE 00-2.2-2.0-K55	PMMA	228 mm	1 mm		2 m	min. 25 mm		
High detection range										
Threaded	M3	KLE-C01-2.2-2.0-K116	PMMA	450 mm	1.5 mm	0.35 mm	2 m	min. 40 mm		

Release date: 2018-01-15 17:07 Date of issue: 2018-01-15 803587_eng.xml

Head shape	Moun-ting	Model number	Core	Detection distance	Fiber cross section	minimum Object size	Fiber optic length	Bend radius	Dimensions	Special features
Threaded	M6	KLE-C01-2.2-2.0-K115	PMMA	450 mm	1.5 mm	0.35 mm	2 m	min. 40 mm		
Threaded	M8 x 1	FEF-PLT1	PMMA	6000 mm calculated value related on 2 m Fiber optic length	1 mm		1 m	min. 25 mm		Narrow beam
Threaded	M8 x 1	FEF-PLT1-L2	PMMA	6000 mm calculated value related on 2 m Fiber optic length	1 mm		2 m	min. 25 mm		Narrow beam
Threaded	M8 x 1	FEF-PLT1-L5	PMMA	6000 mm calculated value related on 2 m Fiber optic length	1 mm		4 m	min. 25 mm		Narrow beam
Cylindrical	dia. 3 mm	KLE-C01-2.2-2.0-K117	PMMA	400 mm	1.5 mm	0.35 mm	2 m	min. 25 mm		
Side view / Periscope										
Cylindrical	dia. 4.75 mm	KHE-C01-2.2-2.0-K136	PMMA	50 mm	0.5 mm	0.15 mm	2 m	min. 1 mm		only 1 mm Bend radius
Array										
Rectangular	3 x M2 x 0.5	KLE-A16-2.2-2.0-K109	PMMA	100 mm	16 x 0.25 mm	0.05 mm	2 m	min. 25 mm		
Rectangular	3 x M3 x 0.5	KLE-A16-2.2-2.0-K110	PMMA	100 mm	16 x 0.25 mm	0.05 mm	2 m	min. 25 mm		
Rectangular	3 x M3 x 0.5	KLE-A16-2.2-2.0-K111	PMMA	100 mm	16 x 0.25 mm	0.05 mm	2 m	min. 25 mm		
Rectangular	2 x 3.2 mm	KLE-A32-2.2-2.0-K142	PMMA	35 mm	32 x 0.25 mm		2 m	min. 25 mm		
High temperature resistance										
Cylindrical	dia. 3 mm	KHTE-C01-2.2-2.0-K118	PMMA	115 mm	1 mm	0.35 mm	2 m	min. 25 mm		- 55°C ... + 115 °C
Sturdy design										

Release date: 2018-01-15 17:07 Date of issue: 2018-01-15 803587_eng.xml

Refer to "General Notes Relating to Pepperl+Fuchs Product Information".

Head shape	Moun-ting	Model number	Core	Detection distance	Fiber cross section	minimum Object size	Fiber optic length	Bend radius	Dimensions	Special features
Threaded	M3	LHE 00-1.1-1.0-14M3	glass	195 mm	1.1 mm		1 m	4 mm static		- 40°C ... + 180 °C
Threaded	M4 x 0.7 /M2.6	LHE 00-1.1-1.0-20M4	glass	195 mm	1.1 mm		1 m	4 mm static		4 x high Detection range with Auxillary lens K-LA01/ 8 x high Detection range with Auxillary lens K-LA06 Side view / Periscope with K-LA02/ - 40°C ... + 180 °C
Threaded	M6	LHE 00-1.1-1.0-G	glass	195 mm	1.1 mm		1 m	4 mm static		- 40°C ... + 180 °C
Cylindrical	dia. 1.5 mm	LHE 00-1.1-1.0-10C1.5	glass	195 mm	1.1 mm		1 m	4 mm static		- 40°C ... + 180 °C
Cylindrical	dia. 3 mm	LHE 00-1.1-1.0-15C3	glass	195 mm	1.1 mm		1 m	4 mm static		- 40°C ... + 180 °C
Right angle	Bar 3 mm	LHE 00-1.1-1.0-WC3	glass	195 mm	1.1 mm		1 m	4 mm static		- 40°C ... + 180 °C
Right angle	Bar 10 mm	LHE 00-1.1-1.0-K9	glass	195 mm	1.1 mm		1 m	4 mm static		- 40°C ... + 180 °C
Special design										
Rectangular	2 x 2.2 mm	KHE-A01-1.0-2.0-K138	PMMA	25 mm	0.5 mm	0.05 mm	2 m	min. 1 mm		only 1 mm Bend radius
Slot	2 x 3.2 mm	KLE-C02-1.25-2.0-K134	PMMA	5 mm	2 x 0.25 m		2 m	min. 10 mm		
Slot	2 x 3.2 mm	KLE-C02-1.25-2.0-K135	PMMA	10 mm	2 x 0.25 m		2 m	min. 10 mm		

Diffuse Mode Sensor Selection Table

Head type	Mounting	Designation	Core	Sensing range	Fiber cross-section	Length of fiber optics	Bending radius	Dimensional drawing	Special Properties
High-precision									

Release date: 2018-01-15 17:07 Date of issue: 2018-01-15 803587_eng.xml

Head type	Mounting	Designation	Core	Sensing range	Fiber cross-section	Length of fiber optics	Bending radius	Dimensional drawing	Special Properties
Thread	M3 x 0.5	KLR-C02-1.0-2.0-K75	PMMA	4 mm	2 x 0.25 m	2 m	At least 10 mm		
Thread	M4 x 0.7	KLR-C02-1.0-2.0-K73	PMMA	4 mm	2 x 0.25 mm	2 m	At least 10 mm		
Thread	M3 x 0.5	KLR-C04-1.25-2.0-K78	PMMA	8 mm	4 x 0.25 m	2 m	At least 15 mm		
Cylindrical	Dia. 2.0 mm	KLR-C02-1.0-2.0-K91	PMMA	4 mm	2 x 0.25 mm	2 m	At least 10 mm		
Cylindrical	Dia. 3.0 mm	KLR-C02-1.0-2.0-K90	PMMA	4 mm	2 x 0.25 mm	2 m	At least 10 mm		
Cylindrical	Dia. 1.5 mm	KLR-C04-1.25-2.0-K80	PMMA	8 mm	4 x 0.25 mm	2 m	At least 15 mm		
Cylindrical	Dia. 1.5 mm	KLR-C04-1.0-2.0-K133	PMMA	7 mm	4 x 0.25 mm	2 m	At least 15 mm		
Cylindrical	Dia. 2.0 mm	KLR-C02-1.0-2.0-K87	PMMA	25 mm	2 x 0.5 mm	2 m	At least 15 mm		
Cylindrical	Dia. 3.0 mm	KLR-C04-1.25-2.0-K79	PMMA	8 mm	4 x 0.25 mm	2 m	At least 15 mm		
Coaxial									
Thread	M3 x 0.5	KLR-C09-1.25-2.0-K76	PMMA	30 mm	1 x 0.5 mm emitter 9 x 0.25 mm receiver	2 m	At least 15 mm		Only 0.5 mm light spot at 8 mm With auxiliary lens K-LA03
Thread	M4 x 0.7 / M2.6	KLR-C09-1.25-2.0-K74	PMMA	30 mm	1 x 0.5 mm emitter 9 x 0.25 mm receiver	2 m	At least 15 mm		Only 0.7 mm light spot at 10 mm with auxiliary lens K-LA04/ two times higher detection range with auxiliary lens K-LA01/ three times higher detection range with auxiliary lens K-LA06

Release date: 2018-01-15 17:07 Date of issue: 2018-01-15 803587_eng.xml

Refer to "General Notes Relating to Pepperl+Fuchs Product Information".

Pepperl+Fuchs Group
www.pepperl-fuchs.com

USA: +1 330 486 0001
fa-info@us.pepperl-fuchs.com

Germany: +49 621 776 4411
fa-info@de.pepperl-fuchs.com

Singapore: +65 6779 9091
fa-info@sg.pepperl-fuchs.com

Head type	Mounting	Designation	Core	Sensing range	Fiber cross-section	Length of fiber optics	Bending radius	Dimensional drawing	Special Properties
Thread	M6 x 0.75	KLR-C16-2.2-2.0-K71	PMMA	85 mm	1 x 1.0 mm emitter 16 x 0.25 mm receiver	2 m	At least 25 mm		
Cylindrical	Dia. 1.0 mm	KLR-C06-1.25-2.0-K81	PMMA	20 mm	1 x 0.25 mm emitter 6 x 0.25 mm receiver	2 m	At least 15 mm		
Cylindrical	Dia. 3.0 mm	KLR-C09-1.25-2.0-K77	PMMA	30 mm	1 x 0.5 mm emitter 9 x 0.25 mm receiver	2 m	At least 15 mm		
Cylindrical	Dia. 5.0 mm	KLR-C16-2.2-2.0-K72	PMMA	85 mm	1 x 1.0 mm emitter 16 x 0.25 mm Receiver	2 m	At least 25 mm		
Highly flexible									
Thread	M3	KHR-C02-1.0-2.0-K96	PMMA	12 mm	2 x 0.5 mm	2 m	At least 1 mm		
Thread	M4	KHR-C02-1.0-2.0-K95	PMMA	12 mm	2 x 0.5 mm	2 m	At least 1 mm		
Thread	M4	KHR-C02-1.3-2.0-K92	PMMA	60 mm	2 x 1.0 mm	2 m	At least 2 mm		
Thread	M6	KHR-C02-2.2-2.0-K94	PMMA	12 mm	2 x 0.5 mm	2 m	At least 1 mm		
Cylindrical	Dia. 3.0 mm	KHR-C02-1.3-2.0-K93	PMMA	60 mm	2 x 1.0 mm	2 m	At least 2 mm		
Flexible									
Thread	M6 x 0.75	KLR-C02-2.2-2.0-K70	PMMA	80 mm	2 x 1.0 mm	2 m	At least 25 mm		
Cylindrical	Dia. 3.0 mm	KLR-C02-1.3-2.0-K86	PMMA	80 mm	2 x 1.0 mm	2 m	At least 25 mm		

Release date: 2018-01-15 17:07 Date of issue: 2018-01-15 803587_eng.xml

Head type	Mounting	Designation	Core	Sensing range	Fiber cross-section	Length of fiber optics	Bending radius	Dimensional drawing	Special Properties
Cylindrical	Dia. 5.0 mm	KLR-C02-2.2-2.0-K85	PMMA	80 mm	2 x 1.0 mm	2 m	At least 25 mm		
Thread	M3 x 0.5	KLR 00-1.0-2.0-K58	PMMA	20 mm		2 m	At least 15 mm		
Thread	M6	KLR 00-2.2-2.0-K57	PMMA	60 mm		2 m	At least 15 mm		
Long detection range									
Thread		KLR-C02-2.2-2.0-K146	PMMA	150 mm		2 m	At least 40 mm		
Thread		KLR-C10-1.25-2.0-K144	PMMA	30 mm		2 m	At least 15 mm		
Lateral optical face									
Thread	M6	KHR-C02-2.2-2.0-K131	PMMA	60 mm	2 x 1.0 mm	2 m	At least 2 mm		Only 2 mm bending radius
Thread	Dia. 5.0 mm	KHR-C02-1.0-2.0-K132	PMMA	15 mm	2 x 0.5 mm	2 m	At least 1 mm		Only 1 mm bending radius
Array									
Cubic	3 x M2 x 0.5	KLR-A18-1.3-2.0-K82	PMMA	25 mm	18 x 0.25 mm	2 m	At least 25 mm		
Cubic	3 x M3 x 0.5	KLR-A32-2.2-2.0-K83	PMMA	35 mm	10.85 mm	2 m	At least 25 mm		
Cubic	2 x 3.2 mm	KLR-A32-2.2-2.0-K141	PMMA	35 mm	16 x 0.25 mm	2 m	At least 25 mm		
Resistant to high temperatures									

Release date: 2018-01-15 17:07 Date of issue: 2018-01-15 803587_eng.xml

Refer to "General Notes Relating to Pepperl+Fuchs Product Information".

Pepperl+Fuchs Group
www.pepperl-fuchs.com

USA: +1 330 486 0001
fa-info@us.pepperl-fuchs.com

Germany: +49 621 776 4411
fa-info@de.pepperl-fuchs.com

Singapore: +65 6779 9091
fa-info@sg.pepperl-fuchs.com

Head type	Mounting	Designation	Core	Sensing range	Fiber cross-section	Length of fiber optics	Bending radius	Dimensional drawing	Special Properties
Thread	M6	KHTR-C02-2.2-2.0-K88	PMMA	80 mm	2 x 1.0 mm	2 m	At least 25 mm		- 55 °C ... + 115 °C
Cylindrical	Dia. 5.0 mm	KHTR-C02-2.2-2.0-K89	PMMA	80 mm	2 x 1.0 mm	2 m	At least 25 mm		- 55 °C ... + 115 °C
Robust design									
Thread	M3 x 0.5	LHR 00-0.8-1.0-14M3	Glass	40 mm	0.8 mm	1 m	4 mm static		- 40 °C ... + 180 °C
Thread	M4 x 0.7	LHR 00-0.8-1.0-20M4	Glass	40 mm	0.8 mm	1 m	4 mm static		- 40 °C ... + 180 °C
Thread	M6	LHR 00-1.1-1.0-G	Glass	70 mm	1.1 mm	1 m	4 mm static		- 40 °C ... + 180 °C
Cylindrical	Dia. 4.5 mm	LHR 00-1.1-1.0-K1	Glass	70 mm	1.1 mm	1 m	4 mm static		- 40 °C ... + 180 °C
Special design									
Cubic		KHR-C02-1.0-2.0-K129	PMMA	5 ~ 10 mm	2 x 0.5 mm	2 m	At least 1 mm		Crossed light beam for background suppression Only 1 mm bending radius
Cubic		KLR-C02-1.3-2.0-K130	PMMA	1 ~ 8 mm	2 x 1.0 mm	2 m	At least 25 mm		Crossed light beam for background suppression
Cubic	3 x M3 x 0.5	KHR-A02-2.2-2.0-K127	PMMA	50 mm	2 x 1.0 mm	2 m	At least 2 mm		Only 2 mm bending radius
Cubic		KLR-C02-1.25-2.0-K128	PMMA	4 ~ 26 mm	2 x 0.5 mm	2 m	At least 15 mm		Fill level measurement
Cylindrical		KLR-C02-1.25-2.0-K147	PMMA			2 m	At least 40 mm		Fill level detection

Release date: 2018-01-15 17:07 Date of issue: 2018-01-15 803587_eng.xml