



Model Number

RLK61-55-Z/31/135

Retroreflective sensor with V95 quick disconnect

Features

- Cost-optimized series for standard tasks in a special design
- Compact design
- Wide range of mounting options thanks to cubic housing design with M30 thread
- 360° high visibility LEDs
- Programmable ON-delay, OFF-delay, and One-shot timers
- Version for universal voltages
- Relay output

Product information

The Series 61 sensor family is a comprehensive product line, offering five sensing modes. Each sensor is equipped with four LEDs that are highly visible from all directions, indicating Power-On, target presence and marginal excess gain. The widely recognized, polycarbonate housing provides a IP67 protection degree rating. Color-coded labels are clearly printed on the housing to easily identify the sensing mode. DC models offer a 4-in-1 output while AC/DC models have a SPDT relay output rated to 3 A. All versions come standard with an integral multifunction timer, sensitivity adjustment and Light-ON/Dark-ON switch. Series 61 sensors are cross-talk protected and have a high degree of resistance to ambient lighting. Each sensor can be mounted via front and rear slots, rear dovetail guide or M30 x 1.5 mounting base. Additionally, cabled sensor models provide 1/2" - 14 NPT internal threads for use with flexible conduit.

Dimensions

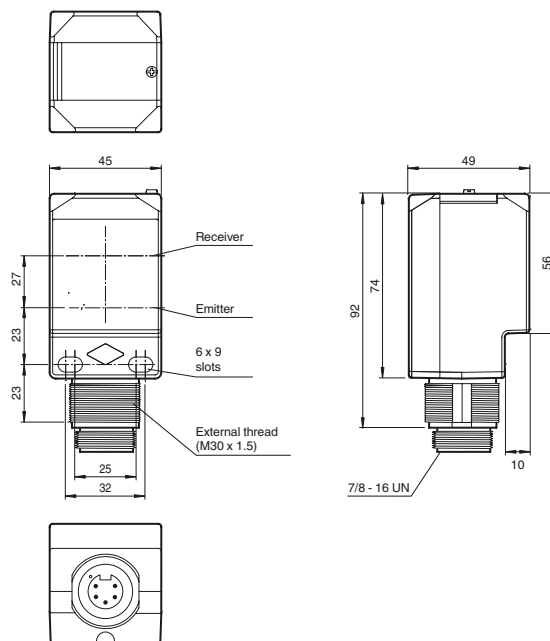

Electrical connection

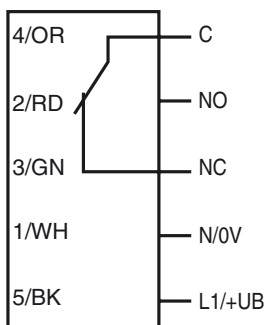

The relay-functions "NC" and "NO" bear on the switching mode "Dark-ON". This complies to the default setting of the light/dark switch (factory setting).

Pinout

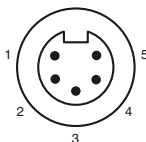

Indicators/operating means

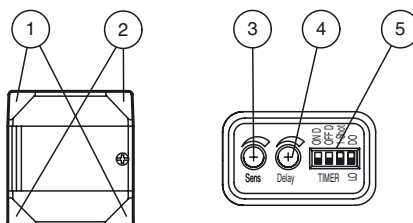

1	Operating display	green
2	Signal display	yellow
3	Sensing range adjuster	
4	Time adjuster	
5	DIP-switches	

Release date: 2017-03-21 14:13 Date of issue: 2017-03-21 911616_eng.xml

Refer to "General Notes Relating to Pepperl+Fuchs Product Information".

Technical data**General specifications**

Effective detection range	0 ... 18 m
Reflector distance	0.3 ... 18 m
Threshold detection range	25 m
Reference target	FE-RR1 reflector
Light source	LED
Light type	modulated visible red light , 630 nm
Polarization filter	yes
Diameter of the light spot	approx. 350 mm at a distance of 18 m
Angle of divergence	1.1 °
Optical face	frontal
Ambient light limit	5000 Lux ; according EN 60947-5-2

Indicators/operating means

Operation indicator	2 LEDs green
Function indicator	2 LEDs yellow lights up when receiving the light beam ; flashes when falling short of the stability control; OFF when light beam is interrupted
Control elements	Light-on/dark-on changeover switch
Control elements	Sensing range adjuster
Control elements	Time adjuster (0 ... 10 s)

Electrical specifications

Operating voltage	U_B	24 ... 240 V AC 12 ... 240 V DC
No-load supply current	I_0	≤ 35 mA
Protection class		II , rated voltage ≤ 250 V AC with pollution degree 1-2 according to IEC 60664-1 Output circuit basis insulation of input circuit according to EN 50178, rated insulation voltage 240 V AC
Power consumption	P_0	≤ 2 VA

Output

Switching type	light/dark on, switchable	
Signal output	1 SPDT relay	
Switching voltage	max. 250 V AC/DC	
Switching current	max. 3 A	
Switching power	DC: max. 150 W AC: max. 750 VA	
Switching frequency	f	20 Hz
Response time	≤ 25 ms	
Timer function	DIP-switch for selection of operating modes	

Ambient conditions

Ambient temperature	-40 ... 55 °C (-40 ... 131 °F)
Storage temperature	-40 ... 70 °C (-40 ... 158 °F)

Mechanical specifications

Degree of protection	IP67
Connection	5-pin V95 connector (7/8"-16 UN 2A)
Material	
Housing	PC (Polycarbonate)
Optical face	PMMA
Mass	approx. 140 g
Tightening torque, fastening screws	≤ 2 Nm

Compliance with standards and directives

Directive conformity	
EMC Directive 2004/108/EC	EN 60947-5-2:2007+A1:2012
Standard conformity	
Product standard	EN 60947-5-2:2007 IEC 60947-5-2:2007
Standards	EN 50178, UL 508

Approvals and certificates

EAC conformity	TR CU 020/2011 TR CU 004/2011
UL approval	cULus Listed, Type 1 enclosure For overcurrent protection, install a fuse with a rated current of max. 5 A and min. 240 V AC/DC
CCC approval	Certified by China Compulsory Certification (CCC)

Accessories**MPZB01**

Mounting bracket with vertical slots

MPZB02

Mounting bracket with circular slots

MPZB06

Ball and Swivel Mounting Bracket

MPZB07

Ball and Swivel Vertical Mounting Plate

V95-G-YE2M-STOOW

Female cordset, 7/8", 5-pin, STOOW cable

V95-W-YE2M-STOOW

Female cordset, 7/8", 5-pin, STOOW cable

Other suitable accessories can be found at www.pepperl-fuchs.com

Curves/Diagrams

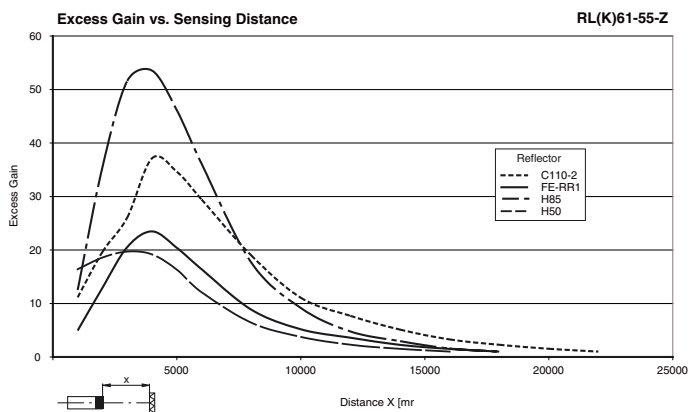
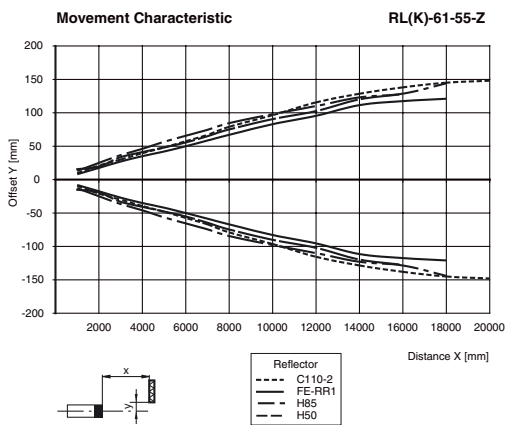

Release date: 2017-03-21 14:13 Date of issue: 2017-03-21 911616_eng.xml

Refer to "General Notes Relating to Pepperl+Fuchs Product Information".

Pepperl+Fuchs Group
 www.pepperl-fuchs.com

USA: +1 330 486 0001
 fa-info@us.pepperl-fuchs.com

Germany: +49 621 776 4411
 fa-info@de.pepperl-fuchs.com

Singapore: +65 6779 9091
 fa-info@sg.pepperl-fuchs.com

Timer Functions

Switching Type	Detection Status	Light Received	No Light Received
L.ON Operation Mode			
OFF ON Timer LO	No Delay (Timer OFF)	ON	OFF
OFF ON Timer LO	ON Delay	ON	OFF
OFF ON Timer LO	OFF Delay	ON	OFF
OFF ON Timer LO	One-Shot Delay	ON	OFF
OFF ON Timer LO	ON Delay and OFF Delay	ON	OFF
D.ON Operation Mode			
OFF ON Timer LO	No Delay (Timer OFF)	ON	OFF
OFF ON Timer LO	ON Delay	ON	OFF
OFF ON Timer LO	OFF Delay	ON	OFF
OFF ON Timer LO	One-Shot Delay	ON	OFF
OFF ON Timer LO	ON Delay and OFF Delay	ON	OFF

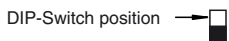

Time (T) is adjustable from 0 to 10 sec

Release date: 2017-03-21 14:13 Date of issue: 2017-03-21 911616_eng.xml

Adjustment Instructions

Intended use:

The retroreflective sensor contains the emitter and receiver in a single housing. The light from transmitter is reflected back from a reflector to the receiver. If an object interrupts the light beam, the switching function is initiated.

Mounting instructions:

The sensor can be mounted using the through-holes or with a mounting bracket (not included with delivery).

The base surface must be flat to avoid distorting the sensor housing during mounting. It is advisable to secure the bolts and screws with washers so that the sensor does not become misaligned.

Adjustment Instructions:

Connect the sensor to operating voltage and the green LED lights up solid.

Mount a suitable reflector opposite the sensor and make a rough adjustment.

The precise adjustment is done by swiveling the sensor horizontally and vertically. With optimum light reception, the yellow LED lights up solid. It will blink if the sensor requires fine adjustment.

Object detection:

Move an object into the light beam. If the object is detected, the yellow LED switches off. If it does not switch off, reduce the sensitivity with the potentiometer until it does. It should light up solid when the object is removed.

Cleaning:

The yellow LED flashes if the light received decreases (e.g. dirty lenses).

We recommend that you clean the optical interfaces and check all connections at regular intervals.