

## Datasheet - EX-ZK 235-11Z-3D



Position switches with safety function / EX-235 Metal enclosure with Actuator / EX-235 Offset roller lever K



(Minor differences between the printed image and the original product may exist!)

- Ex certified
- Metal enclosure
- Wide range of alternative actuators
- Good resistance to oil and petroleum spirit
- 30 mm x 63,5 mm x 30 mm
- Snap action with constant contact pressure up to switching point
- Actuator heads can be repositioned by 4 x 90°
- Mounting details to EN 50047
- Ex-certified screwed cable gland
- 1 Cable entry M 20 x 1.5

### Ordering details

Product type description	EX-ZK 235-11Z-3D
Article number	101197740
EAN Code	4030661365664
eCl@ss	27-27-26-01

### Approval

Approval



EEX

### Classification

Standards	EN ISO 13849-1
B10d Normally-closed contact (NC)	20.000.000
Mission time	20 Years
notice	$MTTF_d = \frac{B_{10d}}{0,1 \times n_{op}}$ $n_{op} = \frac{d_{op} \times h_{op} \times 3600 \text{ s/h}}{t_{cycle}}$

### Global Properties

Permanent light	EX-Z 235 Rollenhebel K
Standards	EN 60947-5-1, EN 60079-0, EN 60079-15, EN 60079-31, BG-GS-ET-15

Compliance with the Directives (Y/N) 	Yes
Suitable for safety functions (Y/N)	Yes
Actuator type	E to EN 50047
Materials	
- Material of the housings	Zink
- Material of the contacts	Silver
Housing coating	painted
Housing construction form	Norm construction design
Weight	197

## Mechanical data

---

Design of electrical connection	Screw connection
Cable cross-section of the cable glands	
- Min. Cable cross-section of the cable glands	6
- Max. Cable cross-section of the cable glands	12
Cable section	
- Min. Cable section	0,75
- Max. Cable section	2.5
AWG-Number	13
Mechanical life	20.000.000 operations
Switching frequency	max. 5000 /h
notice	All indications about the cable section are including the conductor ferrules.
Design of actuating element	Offset roller lever
Actuating force	min. 9 N
Bounce duration	< 3
Switchover time	> 5.5
Positive break force	19
Actuating speed with actuating angle 30° to switch axis	
- Min. Actuating speed	24 mm/min
- Max. Actuating speed	1 m/s

## Ambient conditions

---

Ambient temperature	
- Min. environmental temperature	-20
- Max. environmental temperature	+60
Protection class	IP67

## Electrical data

---

Design of control element	Normally open contact (NO), Opener (NC)
Switching principle	Snap switch element
- positive break NC contact 	
Number of auxiliary contacts	1
Number of safety contacts	1
Rated impulse withstand voltage $U_{imp}$	6 kV
Rated insulation voltage $U_i$	500 V
Thermal test current $I_{the}$	10 A
Utilisation category	AC-15: 230 V / 4 A, DC-13: 24 V / 1 A
Max. fuse rating	6 A gG D-fuse

## ATEX

Marking	EX II 3D Ex tc IIIC T90°C Dc X EX II 3G Ex nC IIC T5 Gc X
Explosion protection categories for gases	3G
Explosion protection Zones for gases	2
Explosion protected category for dusts	3D
Explosion protection Zones for dusts	22

## Dimensions

Dimensions of the sensor	
- Width of sensor	30
- Height of sensor	95.1
- Length of sensor	30

## Keywords

Keywords	Ex, EEx, ATEX, Ex 235, Ex 235, 235 Ex, 235ex, 235ex, ATEX 235
----------	---

## Diagram



Note Diagram

- positive break NC contact
- active
- no active
- Normally-open contact
- Normally-closed contact

## Switch travel diagram

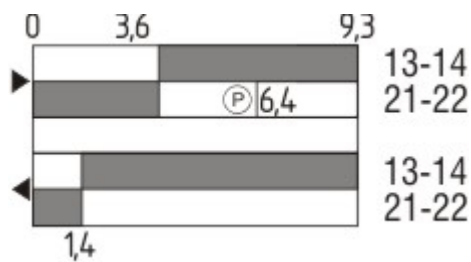

Notes Switch travel diagram

- Contact closed
- Contact open
- Setting range
- Break point
- Positive opening sequence/- angle
- VS** adjustable range of NO contact
- VÖ** adjustable range of NC contact
- N** after travel

## Ordering code

EX-(1)(2) 235-(3)Z-(4)-(5)-(6)-(7)-3D

(1)	
Z	Snap action
T	Slow action
(2)	
S	Plunger S
R	Roller plunger R
4S	Plunger 4S
4R	Roller plunger 4R
1R	Offset roller lever 1R
K	Offset roller lever K
3K	Angle roller lever 3K
4K	Angle roller lever 4K
K4	Angle roller lever K4
1H	Roller lever 1H
7H	Roller lever 7H
10H	Rod lever 10H
12H	Roller lever 12H
14H	Roller lever 14H
(3)	
02	2 Opener (NC)
11	1 Normally open contact (NO) / 1 Opener (NC)
20	2 Normally open contact (NO), (Switch with 2 NO contacts are not for security tasks)
(4)	
H	Slow action with staggered contacts
UE	Slow action with overlapping contacts
(5)	
1297	Enclosure with transverse slotted holes
(6)	
2138	Roller lever 7H for Position switches with safety function
(7)	
1637	gold-plated contacts

## Documents

---

**Operating instructions and Declaration of conformity** (pt) 360 kB, 24.01.2018

Code: mrl\_ex-zt235\_pt

**Operating instructions and Declaration of conformity** (pl) 379 kB, 31.01.2018

Code: mrl\_ex-zt235\_pl

**Operating instructions and Declaration of conformity** (nl) 355 kB, 31.01.2018

Code: mrl\_ex-zt235\_nl

**Operating instructions and Declaration of conformity** (jp) 435 kB, 10.02.2015

Code: mrl\_ex-zt235\_jp

**Operating instructions and Declaration of conformity** (da) 359 kB, 31.01.2018

Code: mrl\_ex-zt235\_da

**Operating instructions and Declaration of conformity** (es) 355 kB, 24.01.2018

Code: mrl\_ex-zt235\_es

**Operating instructions and Declaration of conformity (it)** 355 kB, 31.01.2018

Code: mrl\_ex-zt235\_it

**Operating instructions and Declaration of conformity (de)** 303 kB, 13.11.2017

Code: mrl\_ex-zt235\_de

**Operating instructions and Declaration of conformity (en)** 351 kB, 13.11.2017

Code: mrl\_ex-zt235\_en

**Operating instructions and Declaration of conformity (fr)** 360 kB, 31.01.2018

Code: mrl\_ex-zt235\_fr

**Brochure (de)** 7 MB, 19.10.2016

Code: b\_atep01\_de

**Brochure (en)** 7 MB, 19.10.2016

Code: b\_atep01\_en

**Brochure (it)** 3 MB, 20.07.2007

Code: b\_atep05

**Brochure (es)** 5 MB, 18.08.2009

Code: b\_atep09

## Images

---

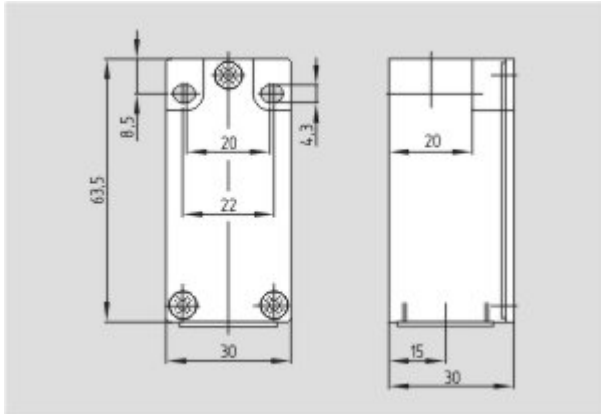

Dimensional drawing (basic component)

---

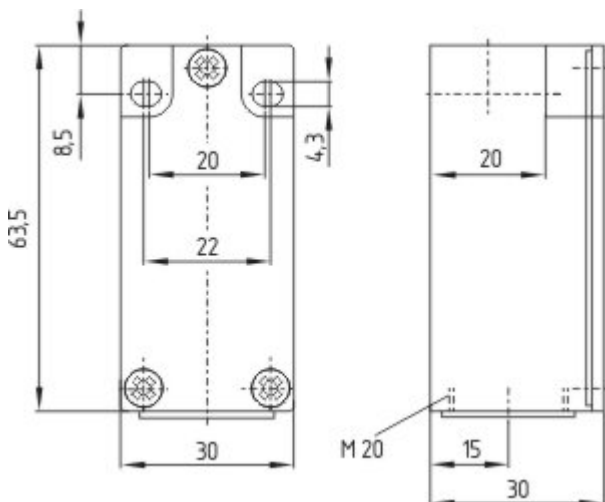

Dimensional drawing (basic component)

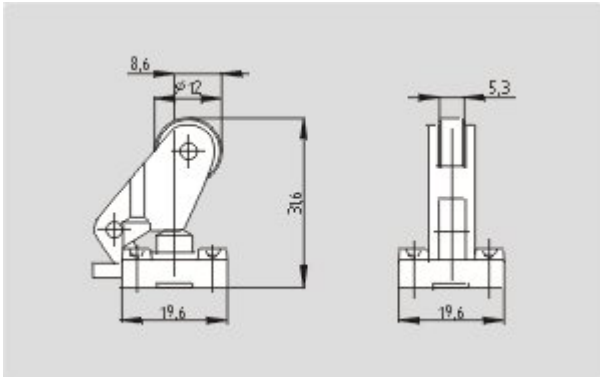

Dimensional drawing (actuator)

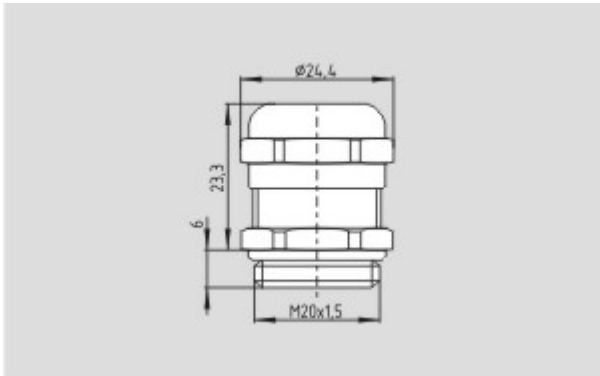

Dimensional drawing (miscellaneous)

K.A. Schmersal GmbH & Co. KG, Mödinghofe 30, D-42279 Wuppertal

The data and values have been checked thoroughly. Technical modifications and errors excepted.

Generiert am 13.02.2019 - 14:01:21h Kasbase 3.3.0.F.64I