

## Datasheet - ZK 235-11Z

Position switch / 235 Metal enclosure - EN 50047 with Actuator / 235 Offset roller lever K



Preferred typ



- Metal enclosure
- Wide range of alternative actuators
- Good resistance to oil and petroleum spirit
- 30 mm x 63,5 mm x 30 mm
- Snap action with constant contact pressure up to switching point
- Actuator heads can be repositioned by 4 x 90°
- Mounting details to EN 50047
- 1 Cable entry M 20 x 1.5

(Minor differences between the printed image and the original product may exist!)

### Ordering details

Product type description	ZK 235-11Z
Article number	101164307
EAN Code	4030661205458
eCl@ss	27-27-26-01

### Approval

Approval

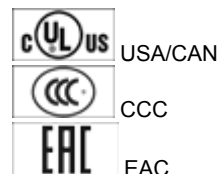

### Classification

Standards	ISO 13849-1
B10d Normally-closed contact (NC)	20.000.000
Mission time	20 Years
notice	$MTTF_d = \frac{B_{10d}}{0,1 \times n_{op}}$ $n_{op} = \frac{d_{op} \times h_{cp} \times 3600 \text{ s/h}}{t_{cycle}}$

### Global Properties

Permanent light	Z 235 Rollenhebel K
Standards	IEC 60947-5-1, ISO 13849-1, BG-GS-ET-15
Compliance with the Directives (Y/N) 	Yes
Suitable for safety functions (Y/N)	Yes
Actuator type	E to EN 50047
Materials	
- Material of the housings	Zink
- Material of the contacts	Silver
Housing coating	painted
Housing construction form	Norm construction design
Weight	155

## Mechanical data

Design of electrical connection	Screw connection
Cable section	
- Min. Cable section	0,75
- Max. Cable section	2.5
Mechanical life	20.000.000 operations
Switching frequency	max. 5000 /h
notice	All indications about the cable section are including the conductor ferrules.
Design of actuating element	Offset roller lever
Actuating force	min. 9 N
Bounce duration	< 3
Switchover time	> 5.5
Positive break force	19 N
Actuating speed with actuating angle 30° to switch axis	
- Min. Actuating speed	24 mm/min
- Max. Actuating speed	1 m/s

## Ambient conditions

Ambient temperature	
- Min. environmental temperature	-30 °C
- Max. environmental temperature	+80 °C
Protection class	IP67

## Electrical data

Design of control element	Normally open contact (NO), Opener (NC)
Switching principle	Snap switch element
- positive break NC contact 	
Number of auxiliary contacts	1
Number of safety contacts	1
Rated impulse withstand voltage $U_{imp}$	6 kV
Rated insulation voltage $U_i$	500 V
Thermal test current $I_{the}$	10 A
Utilisation category	AC-15: 230 V / 4 A, DC-13: 24 V / 1 A
Required rated short-circuit current	1000 A
Max. fuse rating	6 A gG D-fuse

## ATEX

Explosion protection categories for gases	None
Explosion protected category for dusts	None

## Dimensions

### Dimensions of the sensor

- Width of sensor	30 mm
- Height of sensor	95.1 mm
- Length of sensor	30 mm

## Diagram



### Note Diagram

- positive break NC contact
- active
- no active
- Normally-open contact
- Normally-closed contact

## Switch travel diagram

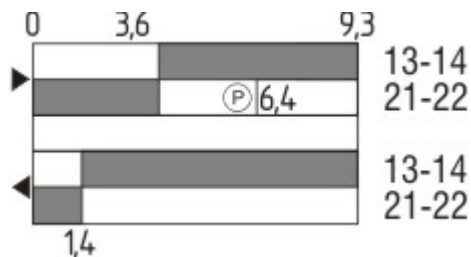

### Notes Switch travel diagram

- Contact closed
- Contact open
- Setting range
- Break point
- Positive opening sequence/- angle
- VS** adjustable range of NO contact
- VÖ** adjustable range of NC contact
- N** after travel

## Ordering suffix

The applicable ordering suffix is added at the end of the part number of the safety switch.

Order example: ZK 235-11Z-**1637**

...-**1637** 0,3 µm gold-plated contacts

...-**NPT** Cable entry NPT 1/2"

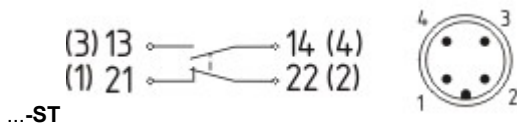

M12 connector with A-coding  
 Rated impulse withstand voltage  $U_{imp}$ : 0,8 kV  
 Rated insulation voltage  $U_i$ : 50 V  
 Rated operating voltage  $U_e$ : 50 V  
 Operating current  $I_e$ : 4 A  
 Caution! The versions with connector may only be used in PELV circuits to EN 60204-1.

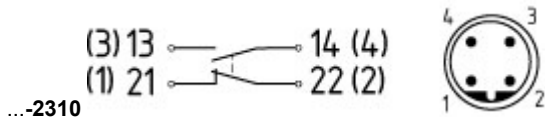

M12 connector with B-coding  
 Rated impulse withstand voltage  $U_{imp}$ : 0,8 kV  
 Rated insulation voltage  $U_i$ : 50 V  
 Rated operating voltage  $U_e$ : 50 V  
 Operating current  $I_e$ : 4 A  
 Caution! The versions with connector may only be used in PELV circuits to EN 60204-1.

...-2574

\$missingName\$

## Ordering code

(1)(2) 2(3)5-(4)Z(5)-(6)-(7)-(8)-(9)

(1)

Z

T

Snap action

Slow action

(2)

S

Plunger S

R

Roller plunger R

4S

Plunger 4S

4R

Roller plunger 4R

1R

Offset roller lever 1R

K

Offset roller lever K

3K

Angle roller lever 3K

4K

Angle roller lever 4K

K4

Angle roller lever K4

1H

Roller lever 1H

7H

Roller lever 7H

10H

Rod lever 10H

12H

Roller lever 12H

14H

Roller lever 14H

AF

Spring rod lever AF

(3)

3

slim design

5

large design

(4)

02

2 Opener (NC)

11

1 Normally open contact (NO) / 1 Opener (NC)

20

2 Normally open contact (NO), (Switch with 2 NO contacts are not for security tasks)

(5)

H

Slow action with staggered contacts

UE

Slow action with overlapping contacts

(6)

without

Cable entry M20

ID

IDC method of termination

<b>NPT</b>	cable entry NPT 1/2"
<b>ST</b>	M12 connector with A-coding ( <i>Caution! The versions with connector may only be used in PELV circuits to EN 60204-1.</i> )
<b>ST-2310</b>	M12 connector with B-coding ( <i>Caution! The versions with connector may only be used in PELV circuits to EN 60204-1.</i> )
<b>(7)</b>	
<b>2574</b>	
<b>(8)</b>	
<b>2138</b>	Roller lever 7H for Position switches with safety function
<b>(9)</b>	
<b>1637</b>	gold-plated contacts

## Documents

---

### Operating instructions and Declaration of conformity (en) 160 kB, 15.06.2018

Code: mrlk\_zt235\_236\_en

### Operating instructions and Declaration of conformity (es) 161 kB, 21.06.2018

Code: mrlk\_ZT235\_236\_es

### Operating instructions and Declaration of conformity (de) 160 kB, 15.06.2018

Code: mrlk\_ZT235\_236\_de

### Operating instructions and Declaration of conformity (pl) 198 kB, 27.06.2018

Code: mrlk\_ZT235\_236\_pl

### Operating instructions and Declaration of conformity (nl) 162 kB, 15.06.2018

Code: mrlk\_ZT235\_236\_nl

### Operating instructions and Declaration of conformity (pt) 163 kB, 27.06.2018

Code: mrlk\_ZT235\_236\_pt

### Operating instructions and Declaration of conformity (it) 162 kB, 15.06.2018

Code: mrlk\_ZT235\_236\_it

### Operating instructions and Declaration of conformity (fr) 164 kB, 15.06.2018

Code: mrlk\_ZT235\_236\_fr

### Operating instructions and Declaration of conformity (cs) 194 kB, 25.01.2019

Code: mrlk\_ZT235\_236\_cs

### Declaration of conformity (es) 91 kB, 18.06.2018

Code: KAS\_konfi\_nsr\_zt2xx-3xx\_es

### Declaration of conformity (pl) 130 kB, 18.06.2018

Code: KAS\_konfi\_nsr\_zt2xx-3xx\_pl

### Declaration of conformity (it) 89 kB, 18.06.2018

Code: KAS\_konfi\_nsr\_zt2xx-3xx\_it

### Declaration of conformity (pt) 90 kB, 18.06.2018

Code: KAS\_konfi\_nsr\_zt2xx-3xx\_pt

### Declaration of conformity (fr) 89 kB, 18.06.2018

Code: KAS\_konfi\_nsr\_zt2xx-3xx\_fr

**Declaration of conformity** (de) 581 kB, 07.06.2018

Code: KAS\_konfi\_nsr\_zt2xx-3xx\_de

**Declaration of conformity** (en) 579 kB, 07.06.2018

Code: KAS\_konfi\_nsr\_zt2xx-3xx\_en

**Declaration of conformity** (nl) 89 kB, 18.06.2018

Code: KAS\_konfi\_nsr\_zt2xx-3xx\_nl

**CCC certification** (cn) 4 MB, 11.04.2018

Code: q\_235p02

**CCC certification** (en) 4 MB, 27.10.2017

Code: q\_235p01

**EAC certification** (ru) 844 kB, 05.10.2015

Code: q\_6037p17\_ru

## Images

---

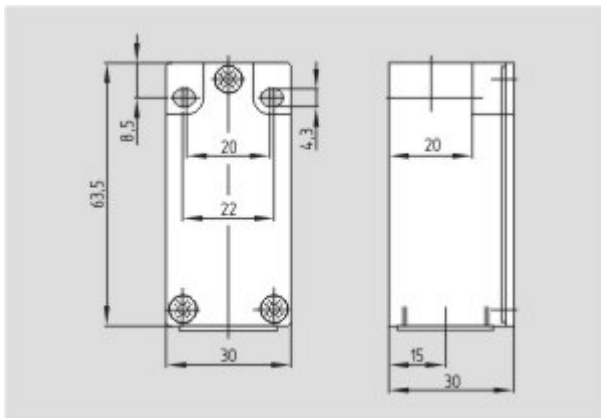

Dimensional drawing (basic component)

---

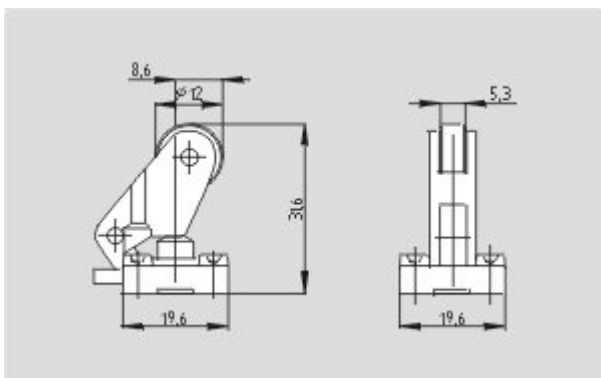

Dimensional drawing (actuator)

---

K.A. Schmersal GmbH & Co. KG, Möddinghofe 30, D-42279 Wuppertal

The data and values have been checked thoroughly. Technical modifications and errors excepted.

Generiert am 13.02.2019 - 13:14:42h Kasbase 3.3.0.F.64I