

## Datasheet - BN 20-2RZ

Magnetic reed switch / BN 20



Preferred typ



- With pre-wired cable
- Non-contact principle
- 2 reed contacts
- Long life
- 104 mm x 52 mm x 47 mm
- Aluminium enclosure
- Actuating distance up to 50 mm depending on actuating magnet and version
- Screw connection
- Highly resistant to vibration
- Available for actuation from front or side

(Minor differences between the printed image and the original product may exist!)

### Ordering details

Product type description	BN 20-2RZ
Article number	101172893
EAN Code	4030661301778
eCl@ss	27-27-01-04

### Approval

Approval	-
----------	---

### Global Properties

Permanent light	BN 20
Standards	EN 60947-5-1
Compliance with the Directives (Y/N) 	Yes
suitable for elevators (Y/N)	No
Active principle	Magnetic drive
Materials	
- Material of the housings	Aluminium
- Material of the active surface	Metal film
Housing construction form	rectangular
Weight	298 g
Recommended actuator	BP 10N, BP 10S, 2 x BP 10N, 2 x BP 10S, BP 15N, BP 15S, 2 x BP

15/2N, 2 x BP 15/2S, BP 34N, BP 34S, BP 20N, BP 20S, BP 31N, BP 31S, BP 11N, BP 11S, 2 x BP 11N, 2 x BP 11S, BP 12N, BP 12S, 2 x BP 12N, 2 x BP 12S, BP 21 N, BP 21S, 2 x BP 21N, 2 x BP 21S, BE 20N, BE 20S

## Mechanical data

---

Design of electrical connection	Screw connection
Mechanical life	1.000.000.000 operations
Electrical lifetime	1.000.000 ... 1.000.000.000 operations
Switching frequency	max. 300/s
Actuating planes	Actuation from side
Active area	lateral
Switch distance	5 ... 50 BP 10N = 5 mm BP 10S = 5 mm 2 x BP 10N = 10 mm 2 x BP 10S = 10 mm BP 15N = 7 mm BP 15S = 7 mm 2 x BP 15/2N = 15 mm 2 x BP 15/2S = 15 mm BP 34N = 10 ... 25 mm BP 34S = 10 ... 25 mm BP 20N = 15 mm BP 20S = 15 mm BP 31N = 15 mm BP 31S = 15 mm BP 11N = 5 mm BP 11S = 5 mm 2 x BP 11N = 15 mm 2 x BP 11S = 15 mm BP 12N = 10 mm BP 12S = 10 mm 2 x BP 12N = 5 ... 20 mm 2 x BP 12S = 5 ... 20 mm BP 21 N = 10 ... 35 mm BP 21 S = 10 ... 35 mm 2 x BP 21N = 15 ... 50 mm 2 x BP 21S = 15 ... 50 mm BE 20N = 10 mm BE 20S = 10 mm
- notice	Actuating distance up to 50 mm depending on actuating magnet and version
Type of actuation	Magnet
resistance to shock	-
resistant to vibration	50 g, on sine wave oscillation
Bounce duration	0,3 ms ... 0,6 ms
Latching (Y/N)	No
bias magnet (Y/N)	Yes
Actuating speed	max. 18 m/s
Switching point accuracy	± 0,25 mm

## Ambient conditions

---

Ambient temperature	
- Min. environmental temperature	-25 °C
- Max. environmental temperature	+90 °C
Protection class	IP67

## Electrical data

---

Design of control element	bistable contact
Number of snap-in contacts	2
Switching time - Close	0,3 ms - 1.5 ms
Switching time - Open	max. 0,5 ms
Voltage type	AC, alternating current
Dielectric strength	> 600 VAC (50 HZ)
Switching voltage	max. 250 VAC
Switching current	max. 3 A
Switching capacity	max. 120 VA / W

## Outputs

---

Design of control output	Reed kontakts
--------------------------	---------------

## LED switching conditions display

---

LED switching conditions display (Y/N)	No
--	----

## ATEX

---

Explosion protection categories for gases	None
Explosion protected category for dusts	None

## Dimensions

---

Dimensions of the sensor	
- Width of sensor	104 mm
- Height of sensor	52 mm
- Length of sensor	47 mm

## notice

---

The opening and closing functions depend on the direction of actuation, the actuating magnets and the polarity of the actuating magnets. When the switches and actuators come together, the colours must coincide: Red (S) to red (S) and green (N) to green (N).

## Included in delivery

---



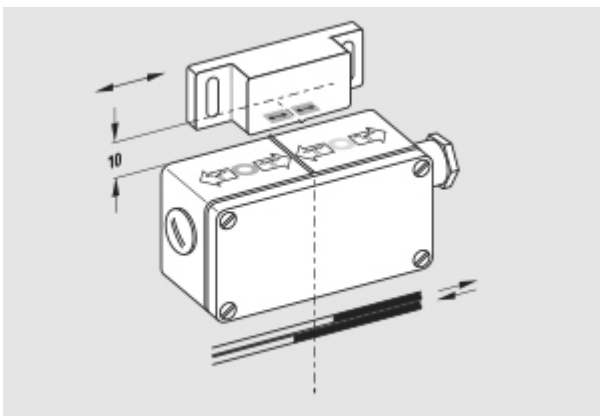

Actuators must be ordered separately.

## Diagram

---



Note Diagram

-  positive break NC contact
-  active
-  no active
-  Normally-open contact
-  Normally-closed contact

## Documents

---

**Operating instructions** (fr) 185 kB, 05.12.2018

Code: mrl\_bn20\_fr

**Operating instructions** (es) 172 kB, 13.09.2018

Code: mrl\_bn20\_es

**Operating instructions** (de) 161 kB, 31.08.2018

Code: mrl\_bn20\_de

**Operating instructions** (en) 168 kB, 31.08.2018

Code: mrl\_bn20\_en

**Operating instructions** (pt) 171 kB, 14.09.2018

Code: mrl\_bn20\_pt

**Operating instructions** (nl) 173 kB, 08.11.2018

Code: mrl\_bn20\_nl

**Operating instructions** (pl) 207 kB, 05.12.2018

Code: mrl\_bn20\_pl

**Declaration of conformity** (en) 186 kB, 12.07.2018

Code: \_\_bn\_p01\_en

**Declaration of conformity** (de) 102 kB, 08.06.2016

Code: \_\_bn\_p01

**notice - Switch distance** (de) 36 kB, 07.08.2009

Code: s\_bnbsp01

**notice - Switch distance** (nl) 39 kB, 07.08.2009

Code: s\_bnbsp04

**notice - Switch distance** (fr) 41 kB, 07.08.2009

Code: s\_bnbsp03

**notice - Switch distance** (pt) 39 kB, 07.08.2009

Code: s\_bnbsp10

**notice - Switch distance** (it) 40 kB, 07.08.2009

Code: s\_bnbsp05

**notice - Switch distance** (es) 38 kB, 07.08.2009

Code: s\_bnbsp09

## Images

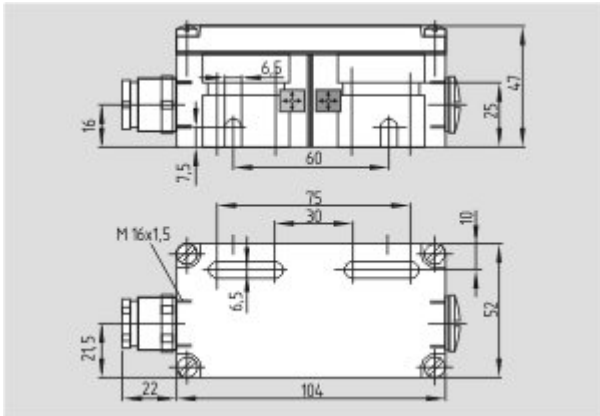

Dimensional drawing (basic component)

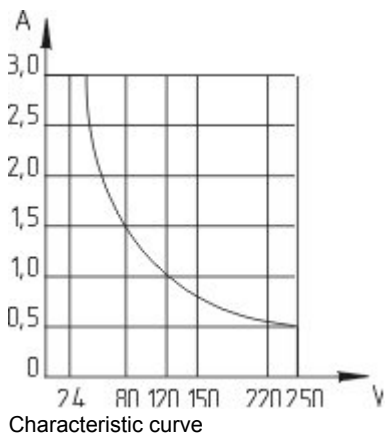

Characteristic curve

## System components

### Actuator

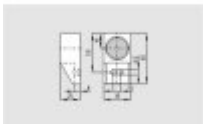

#### 101057534 - BP 21 S

- -metal housing
- S-pole marked red
- Suitable for mounting on ferrous material

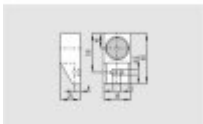

#### 101057536 - BP 21 N

- -metal housing
- N-pole marked green
- Suitable for mounting on ferrous material

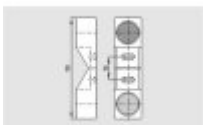

#### 101059921 - BP 21

- -metal housing
- S-pole marked red
- N-pole marked green
- Suitable for mounting on ferrous material

#### 101059917 - BP 12 N

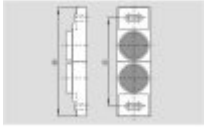

- -metal housing
- N-pole marked green
- Suitable for mounting on ferrous material



**101059916 - BP 12**

- -metal housing
- S-pole marked red
- N-pole marked green
- Suitable for mounting on ferrous material

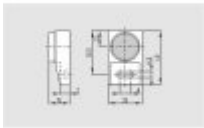

**101057533 - BP 11 S**

- -metal housing
- S-pole marked red
- Suitable for mounting on ferrous material

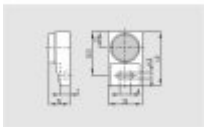

**101059923 - BP 11 N**

- -metal housing
- N-pole marked green
- Suitable for mounting on ferrous material

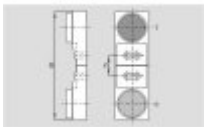

**101059922 - BP 11**

- -metal housing
- S-pole marked red
- N-pole marked green
- Suitable for mounting on ferrous material

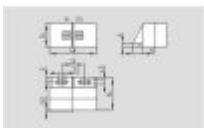

**101057521 - BP 31 S**

- thermoplastic enclosure
- S-pole marked red
- Suitable for mounting on ferrous material with a distance of 20 mm

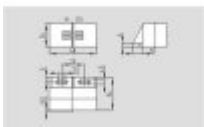

**101057520 - BP 31 N**

- thermoplastic enclosure
- N-pole marked green
- Suitable for mounting on ferrous material with a distance of 20 mm

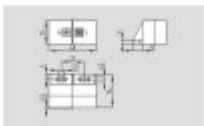

**101057530 - BP 31**

- thermoplastic enclosure
- S-pole marked red
- N-pole marked green
- Suitable for mounting on ferrous material with a distance of 20 mm

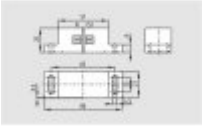

#### 101057541 - BP 20 S

- -metal housing
- S-pole marked red
- Suitable for mounting on ferrous material with a distance of 20 mm

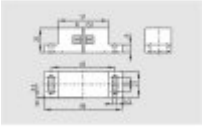

#### 101057538 - BP 20 N

- -metal housing
- N-pole marked green
- Suitable for mounting on ferrous material with a distance of 20 mm

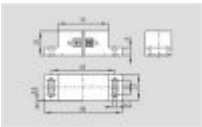

#### 101057549 - BP 20

- -metal housing
- S-pole marked red
- N-pole marked green
- Suitable for mounting on ferrous material with a distance of 20 mm

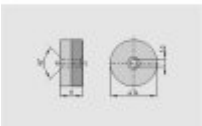

#### 101057553 - BP 34

- thermoplastic enclosure
- S-pole marked red
- N-pole marked green
- Suitable for mounting on ferrous material with a distance of 25 mm



#### 101060165 - BP 15/2

- Unenclosed
- Polarity stamped in
- Suitable for mounting on ferrous material with a distance of 18 mm

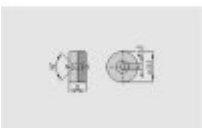

#### 101060163 - BP 15

- thermoplastic enclosure
- N-pole marked green
- S-pole marked red
- Suitable for mounting on ferrous material with a distance of 18 mm



#### 101057531 - BP 10

- Unenclosed
- Colour coding of poles by labels