

## Datasheet - TR 355-20z

Position switch / 355 Metal enclosure - EN 50041 with Actuator / 355 Roller plunger R



- Metal enclosure
- Wide range of alternative actuators
- Good resistance to oil and petroleum spirit
- 66,7 mm x 76 mm x 38 mm
- 3 cable entries lateral M 20 x 1.5
- Actuator heads can be repositioned by 4 x 90°
- Mounting details to EN 50041
- Switching points to EN 50041

(Minor differences between the printed image and the original product may exist!)

### Ordering details

Product type description	TR 355-20Z
Article number	101082442
EAN Code	4030661063478
eCl@ss	27-27-26-01

### Approval

Approval

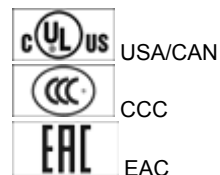

### Classification

Standards	EN ISO 13849-1
Mission time	20 Years
notice	$MTTF_d = \frac{B_{10d}}{0,1 \times n_{op}}$ $n_{op} = \frac{d_{op} \times h_{op} \times 3600 \text{ s/h}}{t_{cycle}}$

### Global Properties

Permanent light	T 355 Rollendruckbolzen R
-----------------	---------------------------

Standards	EN 60947-5-1, BG-GS-ET-15
Compliance with the Directives (Y/N) 	Yes
Suitable for safety functions (Y/N)	No
Actuator type	C to EN 50041
Materials	
- Material of the housings	Aluminium
- Material of the contacts	Silver
Housing coating	painted
Housing construction form	Norm construction design
Weight	230

## Mechanical data

---

Design of electrical connection	Screw connection
Cable section	
- Min. Cable section	0,75
- Max. Cable section	2.5
Mechanical life	30.000.000 operations
Switching frequency	max. 5000 /h
notice	All indications about the cable section are including the conductor ferrules.
Design of actuating element	Roller plunger
Actuating force	min. 17 N
Bounce duration	< 2
Switchover time	in accordance with actuating speed
Actuating speed with actuating angle 30° to switch axis	
- Min. Actuating speed	
- Max. Actuating speed	0,5 m/s

## Ambient conditions

---

Ambient temperature	
- Min. environmental temperature	-30 °C
- Max. environmental temperature	+80 °C
Protection class	IP67

## Electrical data

---

Design of control element	Normally open contact (NO)
Switching principle	Slow action
Number of auxiliary contacts	2
Number of safety contacts	0
Rated impulse withstand voltage $U_{imp}$	6 kV
Rated insulation voltage $U_i$	500 V
Thermal test current $I_{the}$	10 A
Utilisation category	AC-15: 230 V / 4 A, DC-13: 24 V / 4 A
Required rated short-circuit current	1000 A
Max. fuse rating	6 A gG D-fuse

## ATEX

---

Explosion protection categories for gases	None
Explosion protected category for dusts	None

## Dimensions

Dimensions of the sensor

- Width of sensor	66.7 mm
- Height of sensor	116.6 mm
- Length of sensor	38 mm



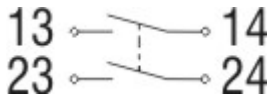

## notice

Switch with 2 NO contacts are not for security tasks

## Diagram





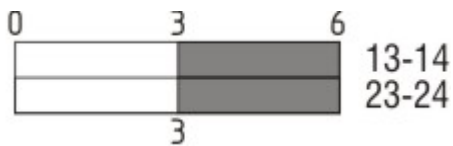

Note Diagram

-  positive break NC contact
-  active
-  no active
-  Normally-open contact
-  Normally-closed contact

## Switch travel diagram



Notes Switch travel diagram

-  Contact closed
  -  Contact open
  -  Setting range
  -  Break point
  -  Positive opening sequence/- angle
- VS** adjustable range of NO contact  
**VÖ** adjustable range of NC contact  
**N** after travel

## Ordering suffix

The applicable ordering suffix is added at the end of the part number of the safety switch.

Order example: TR 355-20z-1637

...-1637 0,3 µm gold-plated contacts

...-NPT Cable entry NPT 1/2"

M12 connector with A-coding  
Rated impulse withstand voltage  $U_{imp}$ : 0,8 kV  
Rated insulation voltage  $U_i$ : 50 V

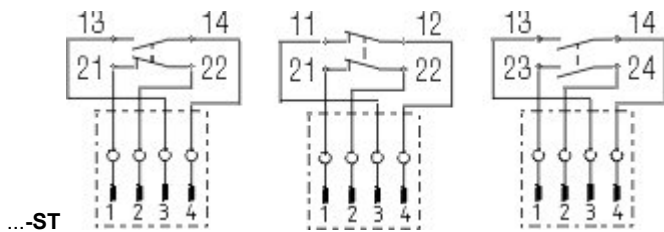

...ST

Operating current  $I_e$ : AC-15: 50 V / 4 A

Caution! The versions with connector may only be used in PELV circuits to EN 60204-1.

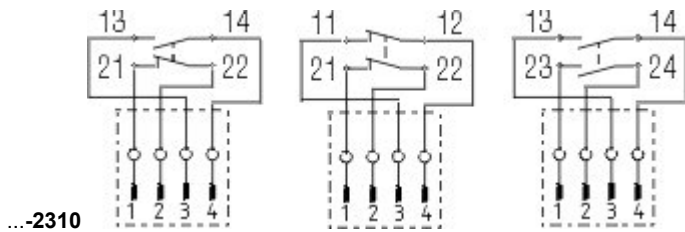

...-2310

M12 connector with B-coding

Rated impulse withstand voltage  $U_{imp}$ : 0,8 kV

Rated insulation voltage  $U_i$ : 50 V

Operating current  $I_e$ : AC-15: 50 V / 4 A

Caution! The versions with connector may only be used in PELV circuits to EN 60204-1.

## Ordering code

(1)(2) 3(3)5-(4)Z(5)-(6)-(7)-(8)-(9)

(1)

Z

T

(2)

S

R

H

10H

7H

1K

3K

(3)

3

5

(4)

11

02

20

01/01

12

03

(5)

H

UE

(6)

G24

(7)

without

NPT

ST

ST-2310

Snap action

Slow action

Plunger S

Roller plunger R

Roller lever H

Rod lever 10H

Roller lever 7H

Offset roller lever 1K

Angle roller lever 3K

slim design

large design

1 Normally open contact (NO) / 1 Opener (NC)

2 Opener (NC)

2 Normally open contact (NO) (*Switch with 2 NO contacts are not for security tasks*)

1 Opener (NC) left / 1 Opener (NC) right

1 Normally open contact (NO) / 2 Opener (NC)

3 Opener (NC)

Slow action with staggered contacts

Slow action with overlapping contacts

with LED

Cable entry M20

cable entry NPT 1/2"

M12 connector with A-coding (*Caution! The versions with connector may only be used in PELV circuits to EN 60204-1.*)

M12 connector with B-coding (*Caution! The versions with connector may only be used in PELV circuits to EN 60204-1.*)

(8)

2138 Roller lever 7H for Position switches with safety function

(9)

1637 gold-plated contacts

## Documents

---

**Operating instructions and Declaration of conformity (de)** 157 kB, 18.06.2018

Code: mrlk\_zt332-335-336-355\_de

**Operating instructions and Declaration of conformity (nl)** 162 kB, 27.06.2018

Code: mrlk\_zt332-335-336-355\_nl

**Operating instructions and Declaration of conformity (it)** 162 kB, 27.06.2018

Code: mrlk\_zt332-335-336-355\_it

**Operating instructions and Declaration of conformity (pt)** 163 kB, 27.06.2018

Code: mrlk\_zt332-335-336-355\_pt

**Operating instructions and Declaration of conformity (pl)** 198 kB, 27.06.2018

Code: mrlk\_zt332-335-336-355\_pl

**Operating instructions and Declaration of conformity (en)** 160 kB, 18.06.2018

Code: mrlk\_zt332-335-336-355\_en

**Operating instructions and Declaration of conformity (fr)** 164 kB, 27.06.2018

Code: mrlk\_zt332-335-336-355\_fr

**Declaration of conformity (es)** 91 kB, 18.06.2018

Code: KAS\_konfi\_nsr\_zt2xx-3xx\_es

**Declaration of conformity (pl)** 130 kB, 18.06.2018

Code: KAS\_konfi\_nsr\_zt2xx-3xx\_pl

**Declaration of conformity (it)** 89 kB, 18.06.2018

Code: KAS\_konfi\_nsr\_zt2xx-3xx\_it

**Declaration of conformity (pt)** 90 kB, 18.06.2018

Code: KAS\_konfi\_nsr\_zt2xx-3xx\_pt

**Declaration of conformity (fr)** 89 kB, 18.06.2018

Code: KAS\_konfi\_nsr\_zt2xx-3xx\_fr

**Declaration of conformity (de)** 581 kB, 07.06.2018

Code: KAS\_konfi\_nsr\_zt2xx-3xx\_de

**Declaration of conformity (en)** 579 kB, 07.06.2018

Code: KAS\_konfi\_nsr\_zt2xx-3xx\_en

**Declaration of conformity (nl)** 89 kB, 18.06.2018

Code: KAS\_konfi\_nsr\_zt2xx-3xx\_nl

**CCC certification (en)** 187 kB, 03.08.2015

Code: q\_347p02

CCC certification (cn) 166 kB, 03.08.2015

Code: q\_347p03

EAC certification (ru) 844 kB, 05.10.2015

Code: q\_6037p17\_ru

## Images

---

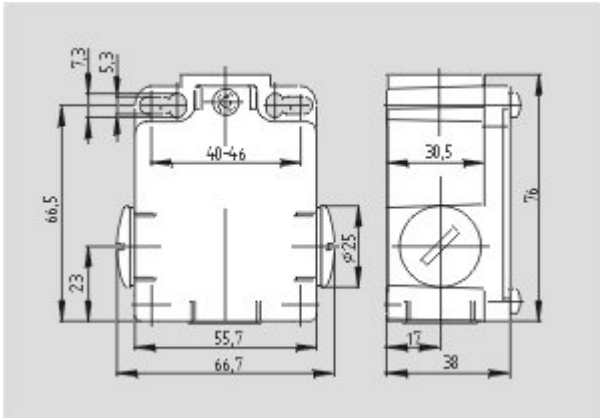

Dimensional drawing (basic component)

---

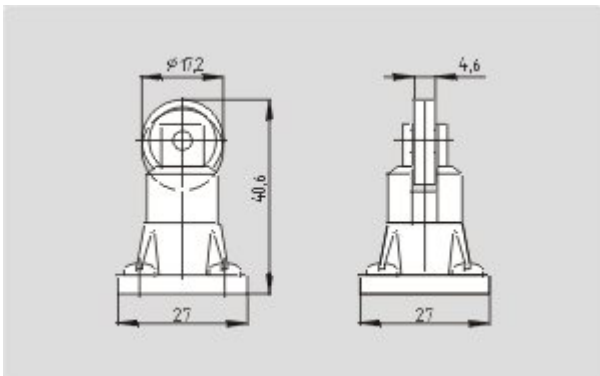

Dimensional drawing (actuator)

---

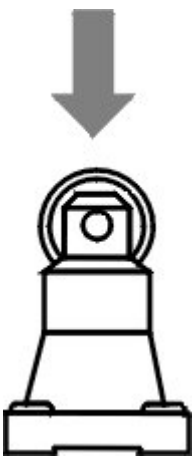

Operating principle

---

K.A. Schmersal GmbH & Co. KG, Mödinghofe 30, D-42279 Wuppertal

The data and values have been checked thoroughly. Technical modifications and errors excepted.

Generiert am 13.02.2019 - 13:29:22h Kasbase 3.3.0.F.64I