

## Datasheet - TV10H 015-02Y



Position switch / medium heavy Position switch / Product series 015, 016, 017 - Metal enclosure / 015 / 015 Rod lever 10H



- Metal enclosure
- 2 Contacts
- 67 mm x 75 mm x 43 mm ( basic component)
- Actuator head can be repositioned in steps 4 x 90°
- Continuous adjustment of lever position 360°
- Lever can be transposed by 180°
- Epoxy resin rod
- 3 Cable entry M 20 x 1.5

(Minor differences between the printed image and the original product may exist!)

### Ordering details

Product type description	TV10H 015-02Y
Article number	101059273
EAN Code	
eCl@ss	27-27-06-01

### Approval

Approval



### Global Properties

Permanent light	015 Stabschwenkhebel 10H
Standards	EN 60947-5-1
Compliance with the Directives (Y/N) 	Yes
Suitable for safety functions (Y/N)	No
Standard housing (Y/N)	No
Materials	
- Material of the housings	light alloy die-casting, painted
- Material of the rod	Epoxy resin
- Material of the contacts	Silver
Housing coating	painted

Weight	347
Slide form	

## Mechanical data

---

Design of electrical connection	Screw connection
Cable section	
- Min. Cable section	1.5
- Max. Cable section	2.5
AWG-Number	13
Active principle	mechanical
Mechanical life	5.000.000 operations
notice	All indications about the cable section are including the conductor ferrules.
Design of actuating element	Rod lever
actuating torque	21
Bounce duration	
Switchover time	
Contact opening	2 x 2.5
Actuating speed with vertical actuating angle to switch axis	
- Min. Actuating speed	1
- Max. Actuating speed	3
- Actuating angle from left of switch axis	30
- Actuating angle from right of switch axis	30

## Ambient conditions

---

Ambient temperature	
- Min. environmental temperature	-30
- Max. environmental temperature	+90
Protection class	IP65 to IEC/EN 60529

## Electrical data

---

Design of control element	Opener (NC)
- with double break	
Switching principle	Creep circuit element
- positive break NC contact	
Number of shutters	0
Number of openers	2
Rated insulation voltage $U_i$	400 V, 10 A
Thermal test current $I_{the}$	10 A
Utilisation category	AC-15: 400 V / 4 A
Max. fuse rating	20 A gG D-fuse

## Dimensions

---



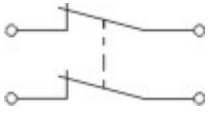

Dimensions of the sensor	
- Width of sensor	67
- Height of sensor	256
- Length of sensor	43
Staff diameter	6

## Diagram

---





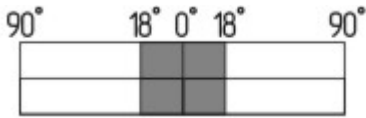

#### Note Diagram

-  positive break NC contact
-  active
-  no active
-  Normally-open contact
-  Normally-closed contact

### Switch travel diagram



#### Notes Switch travel diagram

-  Contact closed
-  Contact open
-  Setting range
-  Break point
-  Positive opening sequence/- angle
- VS** adjustable range of NO contact
- VÖ** adjustable range of NC contact
- N** after travel

### Ordering suffix

The applicable ordering suffix is added at the end of the part number of the safety switch.

Order example: TV10H 015-02Y- C

...- C	Magnetic blow-out Blow-out magnets available to switch high DC currents Rated operating current/voltage $I_e/U_e$ : 1 A / 220 V; 4 A / 24 V Utilisation category: DC-13
...- H	Slow action with staggered contacts

### Ordering code

(1)(2) 015-(3)Y-(4)	
(1)	
T	Slow action
M	Snap action
(2)	
S	Plunger S
2S	Telescopic plunger 2S
K	Offset roller lever K
2K	Rocking offset roller lever 2K
3K	Angle roller lever 3K
8H	Roller lever 8H

7H	Roller lever 7H
10H	Rod lever 10H
H	Roller lever H
4H	Spring rod lever on shaft 4H
2H	Leaf-spring lever 2H
3H	Roller lever 3H
9H	Rod lever 9H
6H	Leaf-spring lever 6H
(3)	
11	1 Normally open contact (NO) / 1 Opener (NC)
02	2 Opener (NC)
20	2 Normally open contact (NO)
(4)	
UE	Slow action with overlapping contacts
H	Slow action with staggered contacts
C	Magnetic blow-out

## Documents

---

**Operating instructions and Declaration of conformity** (nl) 95 kB, 20.07.2018

Code: mrlk\_posi-allgemein\_nl

**Operating instructions and Declaration of conformity** (ru) 133 kB, 09.07.2018

Code: mrlk\_posi-allgemein\_ru

**Operating instructions and Declaration of conformity** (es) 88 kB, 09.07.2018

Code: mrlk\_posi-allgemein\_es

**Operating instructions and Declaration of conformity** (en) 86 kB, 09.07.2018

Code: mrlk\_posi-allgemein\_en

**Operating instructions and Declaration of conformity** (cn) 138 kB, 09.07.2018

Code: mrlk\_posi-allgemein\_cn

**Operating instructions and Declaration of conformity** (it) 86 kB, 09.07.2018

Code: mrlk\_posi-allgemein\_it

**Operating instructions and Declaration of conformity** (jp) 285 kB, 09.07.2018

Code: mrlk\_posi-allgemein\_jp

**Operating instructions and Declaration of conformity** (pl) 118 kB, 09.07.2018

Code: mrlk\_posi-allgemein\_pl

**Operating instructions and Declaration of conformity** (fr) 85 kB, 09.07.2018

Code: mrlk\_posi-allgemein\_fr

**Operating instructions and Declaration of conformity** (pt) 86 kB, 09.07.2018

Code: mrlk\_posi-allgemein\_pt

**Operating instructions and Declaration of conformity** (de) 88 kB, 09.07.2018

Code: mrlk\_posi-allgemein\_de

**Declaration of conformity** (de) 93 kB, 27.03.2017

Code: konfi\_mrl\_tm015\_de

**Declaration of conformity** (en) 91 kB, 07.11.2017

Code: konfi\_mrl\_tm015\_en

**CCC certification** (en) 4 MB, 27.10.2017

Code: q\_372p02

**CCC certification** (cn) 4 MB, 27.10.2017

Code: q\_372p03

**EAC certification** (ru) 388 kB, 20.01.2016

Code: q\_1527p17\_ru

## Images

---

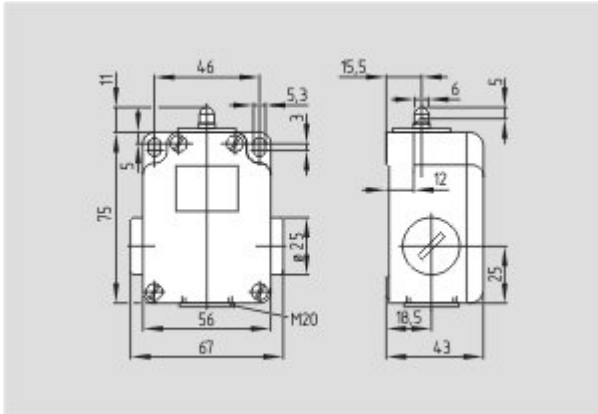

Dimensional drawing (basic component)

---

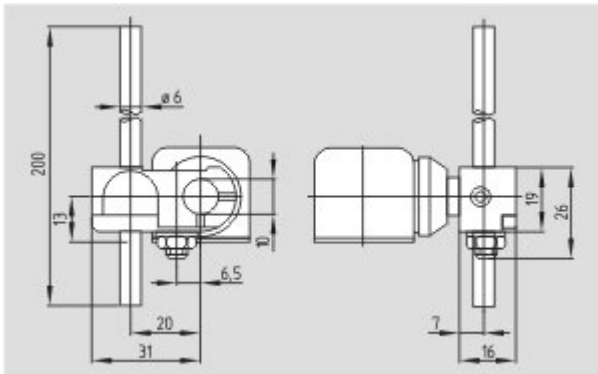

Dimensional drawing (miscellaneous)

---

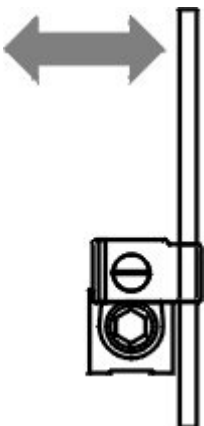

Operating principle

---

K.A. Schmersal GmbH & Co. KG, Möddinghofe 30, D-42279 Wuppertal

The data and values have been checked thoroughly. Technical modifications and errors excepted.

Generiert am 13.02.2019 - 13:34:29h Kasbase 3.3.0.F.64l