

Datasheet - IFL 2-250-10P-1716

Inductive proximity switch / Housing construction form: Block / IFL 250



- Design 250
- Thermoplastic enclosure
- DC 3-wire
- Double-insulated
- cable output lateral

(Minor differences between the printed image and the original product may exist!)

Ordering details

Product type description	IFL 2-250-10P-1716
Article number	101097778
EAN Code	4030661019376
eCl@ss	27-27-01-01

Global Properties

Permanent light	IFL - 250
Standards	IEC/EN 60947-5-2; DIN VDE 0660-208
Compliance with the Directives (Y/N) 	Yes
Operating resource protection class	Protection class 2
Materials	
- Material of the housings	Plastic
- Material of the cable mantle	PVC
Housing coating	None
Housing construction form	Block
Weight	56

Mechanical data

Design of electrical connection	Cable
Cable length	2
Conductor with strain relief	No
Conductors	3 x 0,34
mechanical installation conditions	flush
Switch distance S_n	2 mm
Reduction factor 1 met (Y/N)	No
Protection circuit	inductive interference protection, Protection against polarity reversal, short-circuit and overload proof

Pressure resistant (Y/N) No

Ambient conditions

Ambient temperature
- Min. environmental temperature -25
- Max. environmental temperature +70
Protection class IP67 to IEC/EN 60529

Electrical data

Design of control element Normally open contact (NO)
Number of wire 3
Voltage type DC, direct current
Supply voltage U_B
- Min. supply voltage 10
- Max. supply voltage 30
Switch frequency approx. 1000 HZ
Voltage drop U_d approx. 1.2 V (200 mA)
Operating current I_e 200 mA
No-load current I_0 approx. 3 mA (24 V)

Outputs

Design of control output PNP

LED switching conditions display

LED switching conditions display (Y/N) Yes
- yellow LED

ATEX

Explosion protection categories for gases None
Explosion protected category for dusts None

Dimensions

Dimensions of the sensor
- Width of sensor 40
- Height of sensor 25
- Length of sensor 12



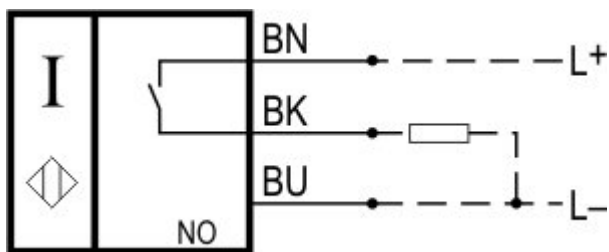

notice

Switches can be mounted adjacent to each other without interference.
with 2 screws M3 x 6 for rear mounting
maximum screwing depth: 6 mm

Diagram



Note Diagram

-  positive break NC contact
-  active
-  no active
-  Normally-open contact
-  Normally-closed contact

Ordering code

IFL (1)-(2)-(3)(4)(5)-(6)

(1)	
2	Switch distance 2 mm
4	Switch distance 4 mm
(2)	
250	Block Design, 40 x 25 x 12 mm
(3)	
01	Opener (NC)
10	Normally open contact (NO)
10/01	Normally open contact (NO) / Opener (NC) with Wiring compartment
11	Normally open contact (NO) / Opener (NC) antivalent
(4)	
without	Cable
D	DC 2-wire
(5)	
N	n-type
P	p-type
(6)	
1716	cable entries from sides

Documents

Operating instructions (nl) 134 kB, 01.08.2018

Code: mrl_ifl-allgemein_nl

Operating instructions (en) 128 kB, 31.08.2016

Code: mrl_ifl-allgemein_en

Operating instructions (pl) 137 kB, 21.10.2016

Code: mrl_ifl-allgemein_pl

Operating instructions (pt) 109 kB, 06.04.2017

Code: mrl_ifl-allgemein_pt

Operating instructions (it) 108 kB, 21.10.2016

Code: mrl_ifl-allgemein_it

Operating instructions (es) 110 kB, 21.10.2016

Code: mrl_ifl-allgemein_es

Operating instructions (cn) 177 kB, 05.05.2017

Code: mrl_ifl-allgemein_cn

Operating instructions (de) 131 kB, 31.08.2016

Code: mrl_ifl-allgemein_de

Operating instructions (fr) 110 kB, 21.10.2016

Code: mrl_ifl-allgemein_fr

Declaration of conformity (en) 91 kB, 13.04.2017

Code: konfi_ifl_en

Declaration of conformity (de) 96 kB, 01.07.2016

Code: konfi_ifl_de

Images

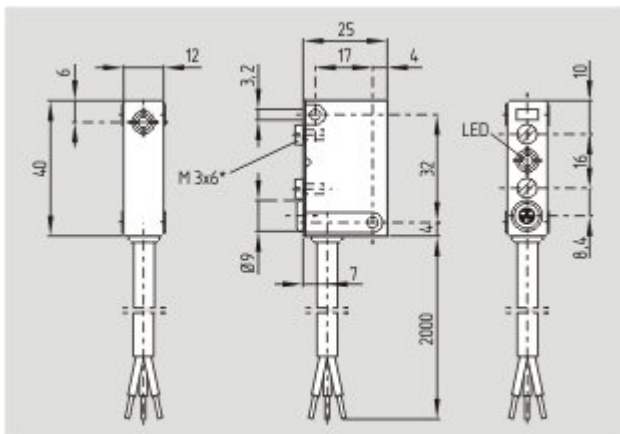

Dimensional drawing (basic component)

K.A. Schmersal GmbH & Co. KG, Möddinghofe 30, D-42279 Wuppertal

The data and values have been checked thoroughly. Technical modifications and errors excepted.

Generiert am 13.02.2019 - 13:05:39h Kasbase 3.3.0.F.64I