

## Datasheet - T4S 236-02ZH



Position switch / 236 Thermoplastic enclosure - EN 50047 with Actuator / 236 Plunger with central mounting 4S



(Minor differences between the printed image and the original product may exist!)

- Thermoplastic enclosure
- Good resistance to oil and petroleum spirit
- Wide range of alternative actuators
- 30 mm x 58,5 mm x 30 mm
- 1 Cable entry M 20 x 1.5
- Double-insulated
- Mounting details to EN 50047
- Actuator heads can be repositioned by 4 x 90°

### Ordering details

Product type description	T4S 236-02ZH
EAN Code	4030661135748
eCl@ss	27-27-26-01

### Approval

Approval

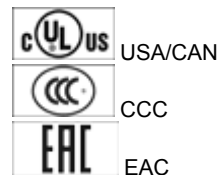

### Classification

Standards	ISO 13849-1
B10d Normally-closed contact (NC)	20.000.000
Mission time	20 Years
notice	$MTTF_d = \frac{B_{10d}}{0,1 \times n_{op}}$ $n_{op} = \frac{d_{ap} \times h_{op} \times 3600 \text{ s/h}}{t_{cycle}}$

### Global Properties

Permanent light	T 236 Druckbolzen mit Zentralbefestigung 4S
Standards	IEC 60947-5-1, ISO 13849-1, BG-GS-ET-15
Compliance with the Directives (Y/N) 	Yes
Suitable for safety functions (Y/N)	Yes
Materials	
- Material of the housings	Plastic, glass-fibre reinforced thermoplastic, self-extinguishing
- Material of the contacts	Silver
Housing coating	None
Housing construction form	Norm construction design
Weight	75

## Mechanical data

---

Design of actuating element	Plunger
Design of electrical connection	Screw connection
Cable section	
- Min. Cable section	0,75
- Max. Cable section	2.5
Mechanical life	20.000.000 operations
Switching frequency	max. 5000 /h
notice	All indications about the cable section are including the conductor ferrules.
Actuating force	min. 9 N
Bounce duration	in accordance with actuating speed
Switchover time	in accordance with actuating speed
Positive break force	19 N
Actuating speed for vertical actuation	
Actuating speed with actuating angle 0° to switch axis	
- Min. Actuating speed	60 mm/min
- Max. Actuating speed	1 m/s

## Ambient conditions

---

Ambient temperature	
- Min. environmental temperature	-30 °C
- Max. environmental temperature	+80 °C
Protection class	IP67

## Electrical data

---

Design of control element	Opener (NC)
Switching principle	Slow action with staggered contacts
- positive break NC contact 	
Number of auxiliary contacts	0
Number of safety contacts	2
Rated impulse withstand voltage $U_{imp}$	6 kV
Rated insulation voltage $U_i$	500 V
Thermal test current $I_{the}$	10 A
Utilisation category	AC-15: 230 V / 4 A, DC-13: 24 V / 1 A
Required rated short-circuit current	1000 A
Max. fuse rating	6 A gG D-fuse

## Dimensions

---

Dimensions of the sensor

- Width of sensor 30 mm
- Height of sensor 101.5 mm
- Length of sensor 30 mm

Diagram

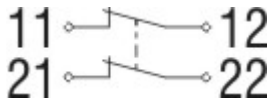

Note Diagram

- positive break NC contact
- active
- no active
- Normally-open contact
- Normally-closed contact

Switch travel diagram

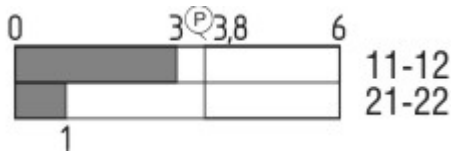

Notes Switch travel diagram

- Contact closed
- Contact open
- Setting range
- Break point
- Positive opening sequence/- angle
- VS** adjustable range of NO contact
- VÖ** adjustable range of NC contact
- N** after travel

Ordering suffix

The applicable ordering suffix is added at the end of the part number of the safety switch.

Order example: T4S 236-02ZH-1637

- ...-1637 0,3 µm gold-plated contacts
- ...- ID IDC method of termination
- ...-NPT Cable entry NPT 1/2"
- ...-1297 Enclosure with transverse slotted holes

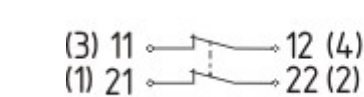

...-ST

- M12 connector with A-coding
- Rated impulse withstand voltage  $U_{imp}$ : 0,8 kV
- Rated insulation voltage  $U_i$ : 50 V
- Operating current  $I_e$ : AC-15: 50 V / 4 A
- Caution! The versions with connector may only be used in PELV circuits to EN 60204-1.

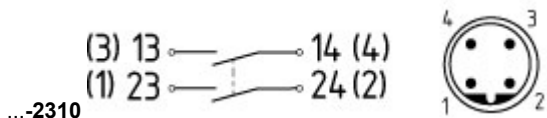

M12 connector with B-coding  
 Rated impulse withstand voltage  $U_{imp}$ : 0,8 kV  
 Rated insulation voltage  $U_i$ : 50 V  
 Operating current  $I_e$ : AC-15 50 V / 4 A  
 Caution! The versions with connector may only be used in PELV circuits to EN 60204-1.

## Ordering code

(1)(2) 2(3)6-(4)Z(5)-(6)-(7)-(8)-(9)

(1)

Z  
T

Snap action  
Slow action

(2)

S  
R  
4S  
4R  
1R  
K  
3K  
4K  
K4  
1H  
7H  
10H  
12H  
14H  
AF

Plunger S  
Roller plunger R  
Plunger 4S  
Roller plunger 4R  
Offset roller lever 1R  
Offset roller lever K  
Angle roller lever 3K  
Angle roller lever 4K  
Angle roller lever K4  
Roller lever 1H  
Roller lever 7H  
Rod lever 10H  
Roller lever 12H  
Roller lever 14H  
Spring rod lever AF

(3)

3  
5

slim design  
large design

(4)

02  
11  
20

2 Opener (NC)  
1 Normally open contact (NO) / 1 Opener (NC)  
2 Normally open contact (NO), (Switch with 2 NO contacts are not for security tasks)

(5)

H  
UE

Slow action with staggered contacts  
Slow action with overlapping contacts

(6)

without  
ID  
NPT  
ST  
ST-2310

Cable entry M20  
IDC method of termination  
cable entry NPT 1/2"  
M12 connector with A-coding  
M12 connector with B-coding

(7)

1297

Enclosure with transverse slotted holes

(8)

2138

Roller lever 7H for Position switches with safety function

(9)

## Documents

---

**Operating instructions and Declaration of conformity (en)** 160 kB, 15.06.2018

Code: mrlk\_zt235\_236\_en

**Operating instructions and Declaration of conformity (es)** 161 kB, 21.06.2018

Code: mrlk\_ZT235\_236\_es

**Operating instructions and Declaration of conformity (de)** 160 kB, 15.06.2018

Code: mrlk\_ZT235\_236\_de

**Operating instructions and Declaration of conformity (pl)** 198 kB, 27.06.2018

Code: mrlk\_ZT235\_236\_pl

**Operating instructions and Declaration of conformity (nl)** 162 kB, 15.06.2018

Code: mrlk\_ZT235\_236\_nl

**Operating instructions and Declaration of conformity (pt)** 163 kB, 27.06.2018

Code: mrlk\_ZT235\_236\_pt

**Operating instructions and Declaration of conformity (it)** 162 kB, 15.06.2018

Code: mrlk\_ZT235\_236\_it

**Operating instructions and Declaration of conformity (fr)** 164 kB, 15.06.2018

Code: mrlk\_ZT235\_236\_fr

**Operating instructions and Declaration of conformity (cs)** 194 kB, 25.01.2019

Code: mrlk\_ZT235\_236\_cs

**Declaration of conformity (es)** 91 kB, 18.06.2018

Code: KAS\_konfi\_nsr\_zt2xx-3xx\_es

**Declaration of conformity (pl)** 130 kB, 18.06.2018

Code: KAS\_konfi\_nsr\_zt2xx-3xx\_pl

**Declaration of conformity (it)** 89 kB, 18.06.2018

Code: KAS\_konfi\_nsr\_zt2xx-3xx\_it

**Declaration of conformity (pt)** 90 kB, 18.06.2018

Code: KAS\_konfi\_nsr\_zt2xx-3xx\_pt

**Declaration of conformity (fr)** 89 kB, 18.06.2018

Code: KAS\_konfi\_nsr\_zt2xx-3xx\_fr

**Declaration of conformity (de)** 581 kB, 07.06.2018

Code: KAS\_konfi\_nsr\_zt2xx-3xx\_de

**Declaration of conformity (en)** 579 kB, 07.06.2018

Code: KAS\_konfi\_nsr\_zt2xx-3xx\_en

**Declaration of conformity (nl)** 89 kB, 18.06.2018

Code: KAS\_konfi\_nsr\_zt2xx-3xx\_nl

**CCC certification** (cn) 4 MB, 11.04.2018

Code: q\_235p02

**CCC certification** (en) 4 MB, 27.10.2017

Code: q\_235p01

**EAC certification** (ru) 844 kB, 05.10.2015

Code: q\_6037p17\_ru

## Images

---

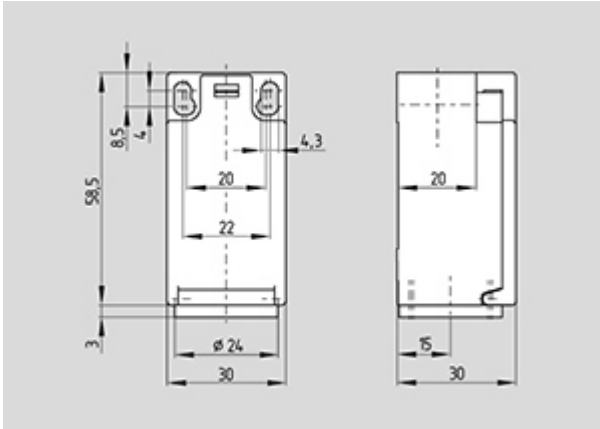

Dimensional drawing (basic component)

---

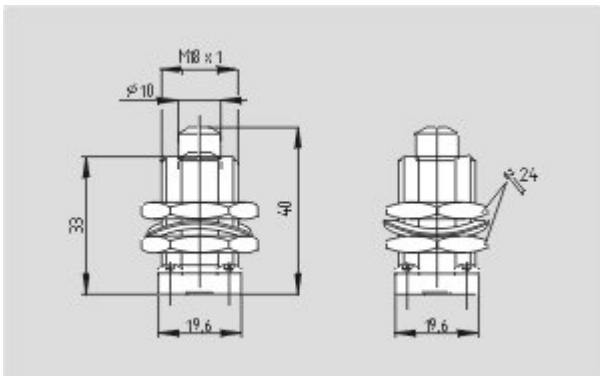

Dimensional drawing (actuator)

---

K.A. Schmersal GmbH & Co. KG, Möddinghofe 30, D-42279 Wuppertal

The data and values have been checked thoroughly. Technical modifications and errors excepted.

Generiert am 13.02.2019 - 13:18:51h Kasbase 3.3.0.F.64I