

Datasheet - TR 422-01Y

Position switch / medium heavy Position switch / T 422 / 422 Roller plunger R



Preferred typ



- Metal enclosure
- 1 Contact
- 106 mm x 71 mm x 63 mm (basic component)
- Protection class IP65
- Actuator can be repositioned by 90°
- 2 cable entries M 20 x 1.5

(Minor differences between the printed image and the original product may exist!)

Ordering details

Product type description	TR 422-01Y
Article number	101058682
EAN Code	4030661033273
eCl@ss	27-27-06-01

Approval

Approval



Global Properties

Permanent light	422 Rollendruckbolzen R
Standards	EN 60947-5-1
Compliance with the Directives (Y/N) 	Yes
Suitable for safety functions (Y/N)	No
Standard housing (Y/N)	No
Materials	
- Material of the housings	cast iron, galvanized
- Roller material	Plastic
- Material of the contacts	Silver
Housing coating	painted

Weight	950
Slide form	Castor

Mechanical data

Design of electrical connection	Screw connection
Cable section	
- Min. Cable section	1.5
- Max. Cable section	2.5
AWG-Number	13
Active principle	mechanical
Mechanical life	10.000.000 operations
notice	All indications about the cable section are including the conductor ferrules.
Design of actuating element	Roller plunger
Bounce duration	
Switchover time	
Contact opening	2 x 6
Actuating speed with vertical actuating angle to switch axis	
- Min. Actuating speed	1
- Max. Actuating speed	0,5
- Actuating angle from left of switch axis	30
- Actuating angle from right of switch axis	30

Ambient conditions

Ambient temperature	
- Min. environmental temperature	-30
- Max. environmental temperature	+90
Protection class	IP65 to IEC/EN 60529

Electrical data

Design of control element	Opener (NC)
- with double break	
Switching principle	Creep circuit element
- positive break NC contact 	
Number of shutters	0
Number of openers	1
Rated insulation voltage U_i	400 V
Thermal test current I_{th}	16 A
Utilisation category	AC-15: 400 V / 4 A
Max. fuse rating	16 A gG D-fuse



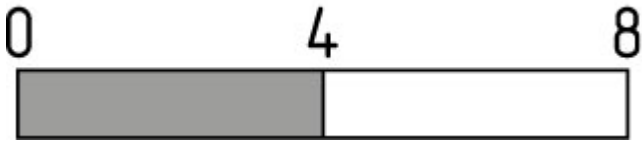

Dimensions

Dimensions of the sensor	
- Width of sensor	106
- Height of sensor	117
- Length of sensor	63
Roller wide	6.5
Roller diameter	25

Switch travel diagram



Notes Switch travel diagram

-  Contact closed
 -  Contact open
 -  Setting range
 -  Break point
 -  Positive opening sequence/- angle
- VS** adjustable range of NO contact
VÖ adjustable range of NC contact
N after travel

Ordering suffix

The applicable ordering suffix is added at the end of the part number of the safety switch.

Order example: TR 422-01Y-T

...-T	Temperature-resistant and tropical version with ceramic insulation for -40°C ... +200°C Rated insulation voltage U_i : 500 V (Snap action)
...- 1276-2	gold-plated contacts
...-RMS	Available with metal roller

Ordering code

T(1) 422-(2)Y-(3)	
(1)	
S	Plunger S
2S	Telescopic plunger 2S
R	Roller plunger R
K	Offset roller lever K
J	Offset roller lever J
2C	Fork lever 2C
L	Roller lever L
D	Roller lever D
(2)	
01	1 Opener (NC)
10	1 Normally open contact (NO)
(3)	
T	Temperature-resistant and tropical version with ceramic insulation for -40°C ... +200°C
1276-2	gold-plated contacts

Documents

Operating instructions and Declaration of conformity (nl) 95 kB, 20.07.2018

Code: mrlk_posi-allgemein_nl

Operating instructions and Declaration of conformity (ru) 133 kB, 09.07.2018

Code: mrlk_posi-allgemein_ru

Operating instructions and Declaration of conformity (es) 88 kB, 09.07.2018

Code: mrlk_posi-allgemein_es

Operating instructions and Declaration of conformity (en) 86 kB, 09.07.2018

Code: mrlk_posi-allgemein_en

Operating instructions and Declaration of conformity (cn) 138 kB, 09.07.2018

Code: mrlk_posi-allgemein_cn

Operating instructions and Declaration of conformity (it) 86 kB, 09.07.2018

Code: mrlk_posi-allgemein_it

Operating instructions and Declaration of conformity (jp) 285 kB, 09.07.2018

Code: mrlk_posi-allgemein_jp

Operating instructions and Declaration of conformity (pl) 118 kB, 09.07.2018

Code: mrlk_posi-allgemein_pl

Operating instructions and Declaration of conformity (fr) 85 kB, 09.07.2018

Code: mrlk_posi-allgemein_fr

Operating instructions and Declaration of conformity (pt) 86 kB, 09.07.2018

Code: mrlk_posi-allgemein_pt

Operating instructions and Declaration of conformity (de) 88 kB, 09.07.2018

Code: mrlk_posi-allgemein_de

Declaration of conformity (de) 94 kB, 08.08.2016

Code: __422p01

Declaration of conformity (pl) 129 kB, 08.08.2016

Code: __422p01_pl

Declaration of conformity (en) 84 kB, 29.11.2018

Code: __422p01_en

CCC certification (cn) 3 MB, 09.04.2018

Code: q_352p03

CCC certification (en) 3 MB, 09.04.2018

Code: q_352p02

EAC certification (ru) 388 kB, 20.01.2016

Code: q_1527p17_ru

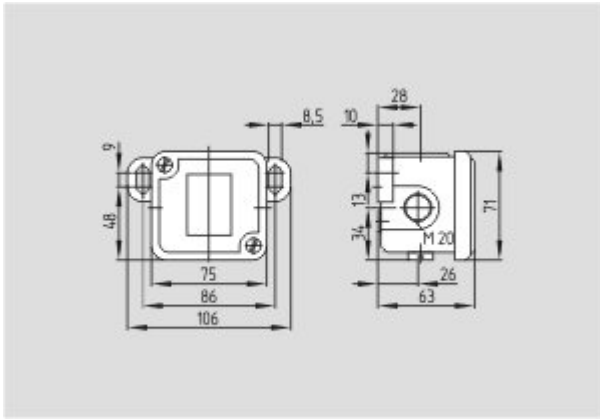

Dimensional drawing (basic component)

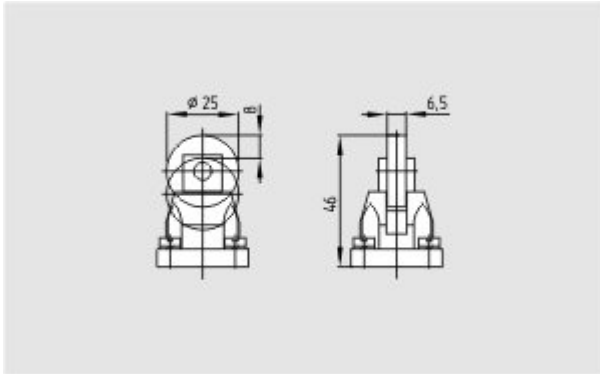

Dimensional drawing (miscellaneous)

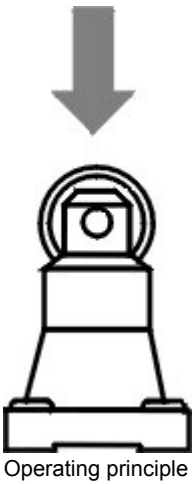

Operating principle