

Datasheet - AZM 161CC-12/12RKED-024

Solenoid interlock / AZM 161



Preferred typ



(Minor differences between the printed image and the original product may exist!)

- Thermoplastic enclosure
- Double-insulated
- Interlock with protection against incorrect locking.
- 130 mm x 90 mm x 30 mm
- 6 Contacts
- Long life
- Large wiring compartment
- Manual release, cover-side
- cable entries 4 M 16 x 1.5

Ordering details

Product type description	AZM 161CC-12/12RKED-024
Article number	101187876
EAN Code	4030661357102
eCl@ss	27-27-26-03

Approval

Approval

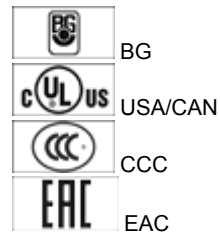

Classification

Standards	EN ISO 13849-1
B10d Normally-closed contact (NC)	2.000.000
Mission time	20 Years
notice	$MTTF_d = \frac{B_{10d}}{0,1 \times n_{op}}$ $n_{op} = \frac{d_{op} \times h_{op} \times 3600 \text{ s/h}}{t_{cycle}}$

Global Properties

Permanent light	AZM 161
Standards	EN 60947-5-1, BG-GS-ET-19
Compliance with the Directives (Y/N) 	Yes
Number of actuating directions	3
Active principle	electromechanical
Duty cycle ED	Magnet 100 %
Materials	
- Material of the housings	Plastic, glass-fibre reinforced thermoplastic, self-extinguishing
- Material of the contacts	Silver
Housing coating	None
Weight	450

Mechanical data

Actuating play in direction of actuation	5.5 mm
Design of electrical connection	Cage clamps
Cable section	
- Min. Cable section	1 x 0,25
- Max. Cable section	1 x 1.5
Mechanical life	> 1.000.000 operations
notice	All indications about the cable section are including the conductor ferrules.
Emergency unlocking device (Y/N)	No
Manual release (Y/N)	Yes
Emergency release (Y/N)	No
Latching force	30
Positive break force	20
positive break travel	10
Clamping force F	2000 N
Max. Actuating speed	2 m/s
Actuating frequency	max. 1000 / h

Ambient conditions

Ambient temperature	
- Min. environmental temperature	-25 °C
- Max. environmental temperature	+60 °C
Protection class	IP67 to IEC/EN 60529

Electrical data

Design of control element	Normally open contact (NO), Opener (NC)
Switching principle	Creep circuit element
Number of auxiliary contacts	2
Number of safety contacts	4
Power to unlock	Yes
Power to lock	No
Rated control voltage U_s	24 VAC/DC
Power consumption	max. 10 W
Power consumption	max. 10 W
Rated impulse withstand voltage U_{imp}	4 kV
Rated insulation voltage U_i	250 V
Thermal test current I_{the}	6 A
Utilisation category	AC-15: 230 V / 4 A, DC-13: 24 V / 2,5 A

Required rated short-circuit current
 Max. fuse rating

1000 A
 6 A gG D-fuse To DIN EN 60269-1

ATEX

Explosion protection categories for gases
 Explosion protected category for dusts

None
 None

Miscellaneous data

Applications

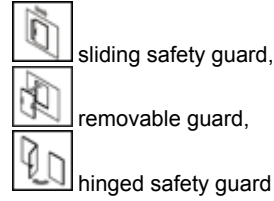

Dimensions

Dimensions of the sensor

- Width of sensor 130 mm
- Height of sensor 90 mm
- Length of sensor 30 mm

notice

Manual release

- For maintenance, installation, etc.
- For manual release using M5 triangular key, available as accessory
- Top-side (ordering suffix -ED) or rear-side (ordering suffix -EU) mounting possible
- A combination of manual release and emergency exit in different mounting directions is only possible for the following variants: -ED/-TU and -TD/-EU

Diagram

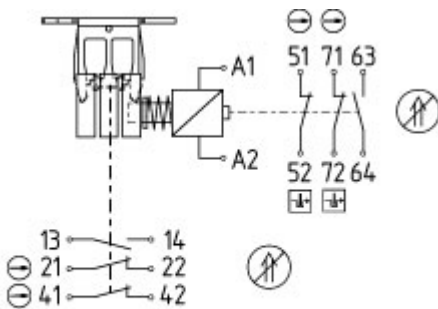

13	14	21	22	41	42	51	52	63	64	71	72	A1	A2
----	----	----	----	----	----	----	----	----	----	----	----	----	----

Note Diagram

- positive break NC contact
- active
- no active
- Normally-open contact
- Normally-closed contact

Switch travel diagram

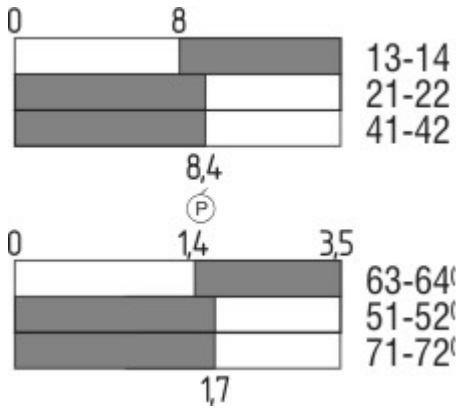

Notes Switch travel diagram

- Contact closed
- Contact open
- Setting range
- Break point
- Positive opening sequence/- angle
- VS** adjustable range of NO contact
- VÖ** adjustable range of NC contact
- N** after travel

Ordering suffix

The applicable ordering suffix is added at the end of the part number of the safety switch.

Order example: AZM 161CC-12/12RKED-024**G**

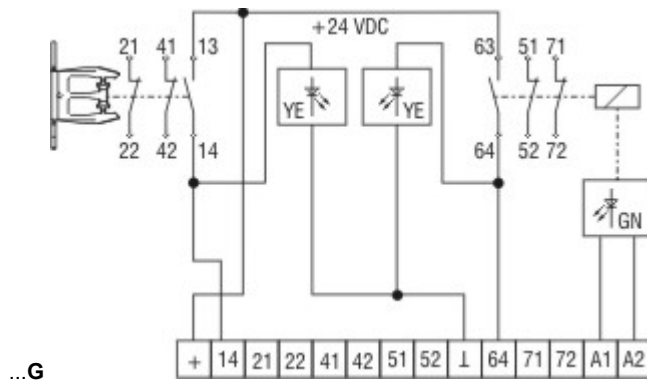

Protected against incorrect polarity and voltage spikes.
limited terminating space 0,75 mm²

Diagram

- 14 guard open
- 13 +24 VDC
- 63 0 VDC
- 64 unlocked

Ordering code

AZM 161 (1)-(2)(3)K(4)-(5)-(6)(7)

(1)

SK

CC

ST

(2)

12/12

12/11

11/12

(3)

without

Screw connection

Cage clamps

male connector M12, 8- and 4-poles (Only for Us: 24 VAC/DC)

2 Normally open contact (NO) / 4 Opener (NC)

2 Normally open contact (NO) / 3 Opener (NC) (Plug-in connection)

2 Normally open contact (NO) / 3 Opener (NC) (Plug-in connection)

Latching force 5 N

R	Latching force 30 N
(4)	
without	Power to unlock
A	Power to lock
(5)	
without	Manual release lateral
ED	Manual release cover-side
EU	Manual release rear
T	Emergency exit lateral
TD	Emergency exit cover-side
TU	Emergency exit rear
N	Emergency release
(6)	
024	Us: 24 VAC/DC
110/230	Us: 110/230 VAC
(7)	
G	with LED (<i>Only for Us: 24 VAC/DC</i>)

Documents

Operating instructions and Declaration of conformity (sv) 423 kB, 15.08.2012

Code: mrl_azm161_sv

Operating instructions and Declaration of conformity (es) 444 kB, 09.03.2016

Code: mrl_azm161_es

Operating instructions and Declaration of conformity (de) 487 kB, 21.01.2019

Code: mrl_azm161_de

Operating instructions and Declaration of conformity (pt) 507 kB, 09.12.2016

Code: mrl_azm161_pt

Operating instructions and Declaration of conformity (en) 523 kB, 21.01.2019

Code: mrl_azm161_en

Operating instructions and Declaration of conformity (pl) 466 kB, 06.04.2016

Code: mrl_azm161_pl

Operating instructions and Declaration of conformity (fr) 444 kB, 28.04.2016

Code: mrl_azm161_fr

Operating instructions and Declaration of conformity (cs) 464 kB, 23.08.2017

Code: mrl_azm161_cs

Operating instructions and Declaration of conformity (jp) 728 kB, 23.08.2016

Code: mrl_azm161_jp

Operating instructions and Declaration of conformity (it) 438 kB, 19.04.2016

Code: mrl_azm161_it

Operating instructions and Declaration of conformity (nl) 473 kB, 03.08.2018

Code: mrl_azm161_nl

BG-test certificate (de) 140 kB, 20.05.2015

Code: z_m16p01

BG-test certificate (en) 134 kB, 20.05.2015

Code: z_m16p02

CCC certification (en) 5 MB, 26.10.2018

Code: q_371p02

CCC certification (cn) 5 MB, 26.10.2018

Code: q_371p03

EAC certification (ru) 809 kB, 05.10.2015

Code: q_6040p17_ru

notice (de, en) 88 kB, 27.09.2007

Code: s_161p01

Images

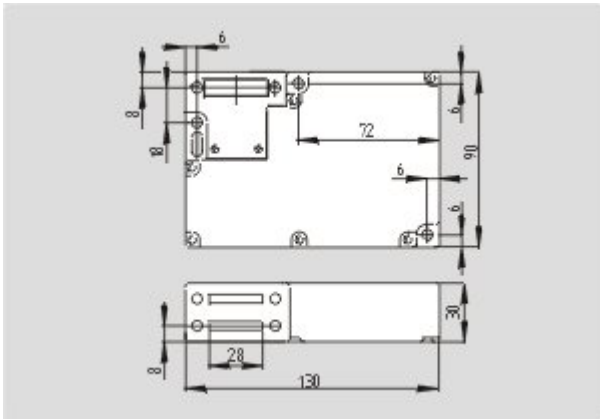

Dimensional drawing (basic component)

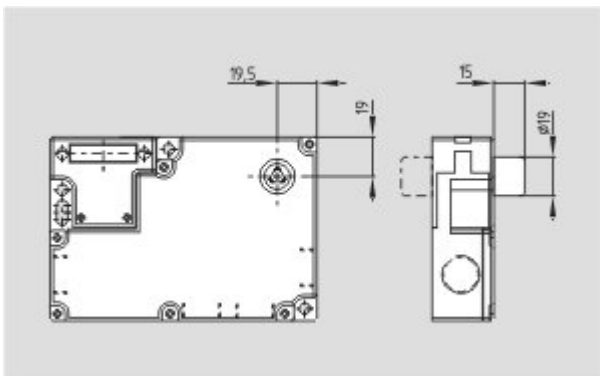

Operating principle

System components

Actuator

101145117 - AZM 161-B1



101144416 - AZM 161-B1E



101171859 - AZM 161-B1ES



101175431 - AZM 161-B1F



101171125 - AZM 161-B1S



101173089 - AZM 161-B1-2053 WITH BALL LATCH



101164100 - AZM 161-B1-1747 WITH MAGNETIC LATCH



101178199 - AZM 161-B1-2024





101176642 - AZM 161-B1-2177 WITH CENTERING GUIDE



101174113 - AZM 161-B6-2177 WITH CENTERING GUIDE

- For very small actuating radii



101170375 - AZM 161-B6S



101144420 - AZM 161-B6

- For very small actuating radii

Door-handle system



AZM 161-STS30

- Latching handle
- Suitable for all types of guard
- suitable in combination with EX-AZM 161
- Max. 110 °C

Accessories



101100887 - TRIANGULAR KEY TK-M5

- For manual release using M5 triangular key, available as accessory
- For maintenance, installation, etc.



101149213 - Mounting set MS AZM 161 R/P

101150376 - Mounting set MS AZM 161 P



K.A. Schmersal GmbH & Co. KG, Möddinghofe 30, D-42279 Wuppertal

The data and values have been checked thoroughly. Technical modifications and errors excepted.

Generiert am 13.02.2019 - 14:42:18h Kasbase 3.3.0.F.64I