

Datasheet - TESK-SA-12ST1

Safety switch for hinged guards / Hinge safety switch / TESK



- Metal enclosure
- connector plug M12 bottom
- with fixed switching angle
- pre-set for front mounting
- Standard hinge

(Minor differences between the printed image and the original product may exist!)

Ordering details

Product type description	TESK-SA-12ST1
Article number	103005747
EAN Code	
eCl@ss	27-27-26-01

Approval

Approval

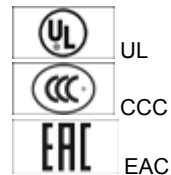

Classification

B10d Normally-closed contact (NC)	2.000.000
B10d Normally open contact (NO)	1.000.000
Mission time	20 Years
Switching frequency c	1200/h
Standards	EN ISO 13849-1
notice	$MTTF_d = \frac{B_{10d}}{0,1 \times n_{op}}$ $n_{op} = \frac{d_{op} \times h_{op} \times 3600 \text{ s/h}}{t_{cycle}}$

Global Properties

Permanent light	TESK
Standards	EN 60947-5-1, BG-GS-ET-15
Compliance with the Directives (Y/N) 	Yes
Materials	
Material of the housings	zinc die-cast
Material of the contacts	Silver-nickel alloy 10
Enclosure color	Silver
Weight	

Mechanical data

Design of electrical connection	Connector M12
Cable section	
- Min. Cable section	0,5
- Max. Cable section	1
Mechanical life	> 1.000.000 operations
notice	All indications about the cable section are including the conductor ferrules.
additional hinge (Y/N)	No
Adjustable switching angle (Y/N)	No
Alignment aid (Y/N)	Yes
Mounting inside (Y/N)	No
Mounting outside (Y/N)	Yes

Ambient conditions

Ambient temperature	
Min. environmental temperature	-25
Max. environmental temperature	+65
Protection class	IP65

Electrical data

Design of control element	Normally open contact (NO), Opener (NC)
Switching principle	Creep circuit element
Number of auxiliary contacts	1
Number of safety contacts	2
Rated impulse withstand voltage	0,5
Rated insulation voltage	30
Thermal test current I _{the}	2.5 A
Utilisation category	AC-15: 230 V / 2 A DC-13: 24 V / 1 A
Max. fuse rating	2 A gG D-fuse
Switching of low voltages	1 mA / 3 VDC

ATEX

Explosion protection categories for gases	None
Explosion protected category for dusts	None

Dimensions

Dimensions of the sensor

- Width of sensor 78
- Height of sensor 116
- Length of sensor 20

Diagram

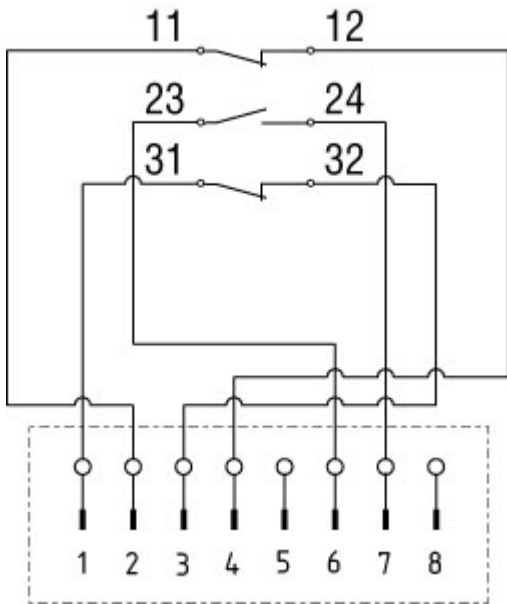

Note Diagram

- positive break NC contact
- active
- no active
- Normally-open contact
- Normally-closed contact

Switch travel diagram

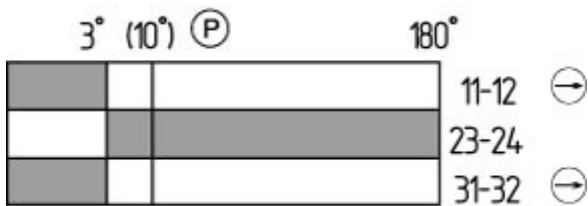

Notes Switch travel diagram

- Contact closed
- Contact open
- Setting range
- Break point
- Positive opening sequence/- angle
- VS** adjustable range of NO contact
- VÖ** adjustable range of NC contact
- N** after travel

Ordering code

TESK-(1)-(2)-(3)-(4)-(5)

(1)

S	
L	
(2)	
A	
I	
U	adjustable switching angle
(3)	
22	2 Normally open contact (NO) / 2 Opener (NC)
12	1 Normally open contact (NO) / 2 Opener (NC)
13	1 Normally open contact (NO) / 3 Opener (NC)
02	2 Opener (NC)
11	1 Normally open contact (NO) / 1 Opener (NC)
(4)	
L1	cable bottom
L2	cable above
ST1	connector plug bottom
ST2	connector plug above
(5)	
3M	Cable length 3 m (only for L1 / L2)
5M	Cable length 5 m (only for L1 / L2)
10M	Cable length 10 m (only for L1 / L2)
20M	Cable length 20 m (only for L1 / L2)
30M	Cable length 30 m (only for L1 / L2)

Documents

Operating instructions and Declaration of conformity (it) 1 MB, 09.10.2018

Code: mrl_tesk_it

Operating instructions and Declaration of conformity (en) 1 MB, 09.10.2018

Code: mrl_tesk_en

Operating instructions and Declaration of conformity (jp) 1 MB, 09.10.2018

Code: mrl_tesk_jp

Operating instructions and Declaration of conformity (fr) 1 MB, 09.10.2018

Code: mrl_tesk_fr

Operating instructions and Declaration of conformity (pt) 1 MB, 09.10.2018

Code: mrl_tesk_pt

Operating instructions and Declaration of conformity (pl) 1 MB, 09.10.2018

Code: mrl_tesk_pl

Operating instructions and Declaration of conformity (es) 1 MB, 09.10.2018

Code: mrl_tesk_es

Operating instructions and Declaration of conformity (de) 1 MB, 09.10.2018

Code: mrl_tesk_de

Operating instructions and Declaration of conformity (nl) 1 MB, 09.10.2018

Code: mrl_tesk_nl

Brochure (en) 641 kB, 12.11.2013

Code: b_tesp01_en

Brochure (pt) 641 kB, 10.12.2013

Code: b_tesp01_pt

Brochure (cs) 675 kB, 01.09.2014

Code: b_tesp01_cs

Brochure (nl) 671 kB, 10.02.2014

Code: b_tesp01_nl

Brochure (it) 639 kB, 26.11.2013

Code: b_tesp01_it

Brochure (jp) 750 kB, 26.06.2014

Code: b_tesp01_jp

Brochure (es) 658 kB, 24.11.2014

Code: b_tesp01_es

Brochure (de) 645 kB, 12.11.2013

Code: b_tesp01_de

Brochure (fr) 641 kB, 26.11.2013

Code: b_tesp01_fr

CCC certification (cn) 107 kB, 20.02.2015

Code: q_tesp02

CCC certification (en) 115 kB, 20.02.2015

Code: q_tesp01

EAC certification (ru) 844 kB, 05.10.2015

Code: q_6037p17_ru

notice (en) 475 kB, 07.08.2017

Code: s_tesp02

notice (de) 513 kB, 07.08.2017

Code: s_tesp01

Images



Product photo

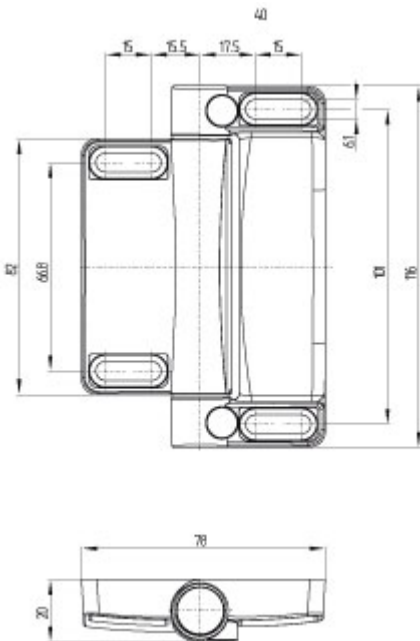

Dimensional drawing (basic component)

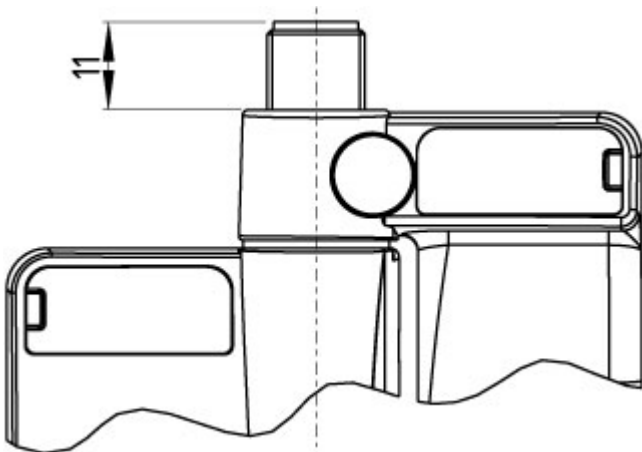

Dimensional drawing (miscellaneous)

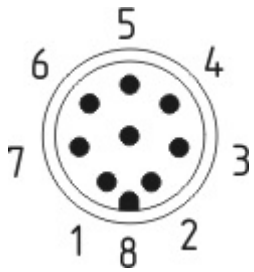

Contact arrangement

K.A. Schmersal GmbH & Co. KG, Möddinghofe 30, D-42279 Wuppertal

The data and values have been checked thoroughly. Technical modifications and errors excepted.

Generiert am 13.02.2019 - 14:33:13h Kasbase 3.3.0.F.64I