

## Datasheet - Mounting set MS AZ 15/16 P

Safety switch with separate actuator / AZ 15 / Accessories AZ 15

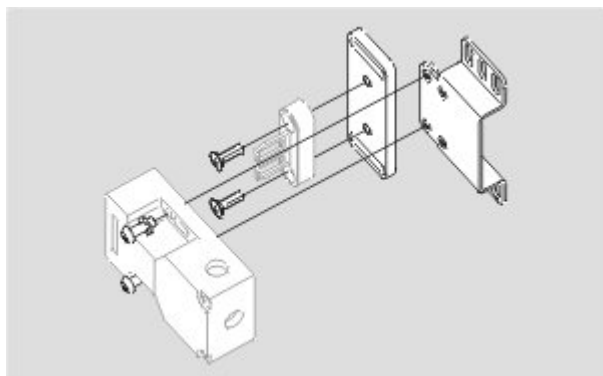

(Minor differences between the printed image and the original product may exist!)

### Ordering details

Product type description	Montagebausatz MS AZ 15/16 P
Article number	101150373
EAN Code	4030661287782
eCl@ss	27-27-92-91

### Global Properties

Permanent light	Montagebausatz
Weight	240

### Mechanical data

mounting	Mounting parallel to safety guard
----------	-----------------------------------

### notice

The mounting sets can only be used in conjunction with actuator AZ 15/16-B6.

### Included in delivery

Included in delivery

- Roundhead screw M5 x 16 per ISO 7380
- Roundhead screw M5 x 10 per ISO 7380
- Washer DIN 125-5,3
- U-profile AZ 16
- Mounting angle AZ 16
- Counter sunk screw M5 x 16 DIN 7991
- Mounting plate AZ 16/AZM 161

### Documents

---

**Operating instructions** (en) 141 kB, 16.05.2018

Code: mrl\_ms\_az15-16\_en

**Operating instructions** (de) 140 kB, 16.05.2018

Code: mrl\_ms\_az15-16\_de

**Operating instructions** (es) 137 kB, 05.06.2018

Code: mrl\_ms\_az15-16\_es

**Operating instructions** (pl) 178 kB, 13.08.2018

Code: mrl\_ms\_az15-16\_pl

**Operating instructions** (fr) 137 kB, 05.06.2018

Code: mrl\_ms\_az15-16\_fr

**Operating instructions** (nl) 141 kB, 23.07.2018

Code: mrl\_ms\_az15-16\_nl

**Operating instructions** (pt) 142 kB, 08.08.2018

Code: mrl\_ms\_az15-16\_pt

## Images

---

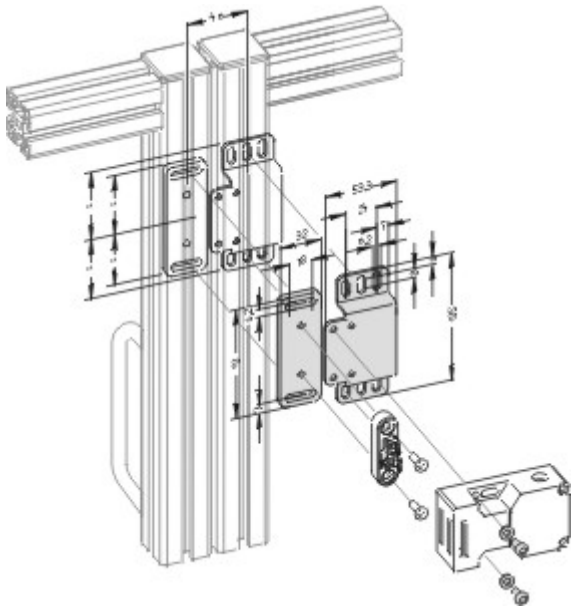

Product graph (exploded-view drawing)

---

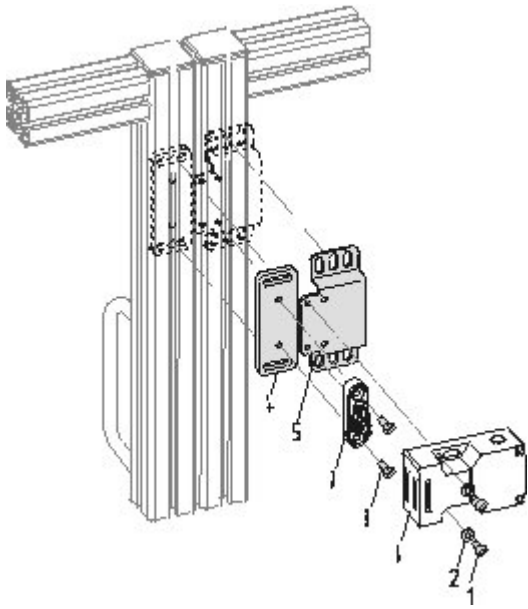

Product graph (exploded-view drawing)

---

K.A. Schmersal GmbH & Co. KG, Möddinghofe 30, D-42279 Wuppertal  
The data and values have been checked thoroughly. Technical modifications and errors excepted.  
Generiert am 13.02.2019 - 14:34:48h Kasbase 3.3.0.F.64I