

## Datasheet - AZM 170-11ZRIA-ST-B6L 24 VAC/DC

Solenoid interlock / AZM 170i / AZM 170i-B6L



- Double-insulated
- Individual coding
- Coding level "High" according to ISO 14119
- 90 mm x 84 mm x 30 mm
- Compact design
- Interlock with protection against incorrect locking.
- Long life
- High holding force
- left-hand model
- For very small actuating radii in line with or at 90° to the plane of the actuator
- Connector M12, 4-pole
- A- and B-coding of the connectors

(Minor differences between the printed image and the original product may exist!)

### Ordering details

Product type description	AZM 170-11ZRIA-ST-B6L 24 VAC/DC
Article number	101144374
EAN Code	4030661133157
eCl@ss	27-27-26-03

### Approval

Approval

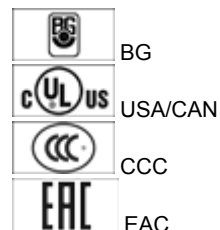

### Classification

Standards	EN ISO 13849-1
B10d Normally-closed contact (NC)	2.000.000
Mission time notice	20 Years

$$MTTF_d = \frac{B_{10d}}{0,1 \times n_{op}}$$

$$n_{op} = \frac{d_{op} \times h_{op} \times 3600 \text{ s/h}}{t_{cycle}}$$

## Global Properties

---

Permanent light	AZM 170I
Standards	EN 60947-5-1, BG-GS-ET-19
Compliance with the Directives (Y/N) 	Yes
Number of actuating directions	2
Active principle	electromechanical
- Individual coding	
- Coding level "High" according to ISO 14119	
Duty cycle ED	Magnet 100 %
Materials	
- Material of the housings	Plastic, glass-fibre reinforced thermoplastic, self-extinguishing
- Material of the actuator	Stainless steel
- Material of the contacts	Silver
Housing coating	None
Weight	288

## Mechanical data

---

Design of electrical connection	Connector M12
Mechanical life	> 1.000.000 operations
Emergency unlocking device (Y/N)	No
Manual release (Y/N)	No
Emergency release (Y/N)	No
Latching force	30
Positive break force	8.5
positive break travel	11 mm
Clamping force F	1000 N
Max. Actuating speed	2 m/s
Minimum actuating radius	50 mm

## Ambient conditions

---

Ambient temperature	
- Min. environmental temperature	-25 °C
- Max. environmental temperature	+60 °C
Protection class	IP67 to IEC/EN 60529

## Electrical data

---

Design of control element	Normally open contact (NO), Opener (NC)
Switching principle	Creep circuit element
Number of auxiliary contacts	1
Number of safety contacts	1
Power to unlock	No
Power to lock	Yes
Rated control voltage U <sub>s</sub>	24 VAC/DC
Power consumption	max. 10 W
Power consumption	max. 10 W
Rated impulse withstand voltage U <sub>imp</sub>	4 kV

Rated insulation voltage $U_i$	250 V
Thermal test current $I_{the}$	10 A
Utilisation category	AC-15: 230 V / 4 A
Max. fuse rating	6 A gG D-fuse

## ATEX

Explosion protection categories for gases	None
Explosion protected category for dusts	None

## Miscellaneous data

Applications



sliding safety guard,



removable guard,



hinged safety guard

## Dimensions

Dimensions of the sensor

- Width of sensor	108
- Height of sensor	75.5
- Length of sensor	30 mm

## notice

Actuating radius adjustable, minimum 50 mm, using an hexagonal key wrench 2 mm A/F ( ) a

**The actuator is not available separately.**

The axis of the hinge should be 11 mm above the top edge of the safety switch and in the same plane

## Included in delivery

Included in delivery

- Individually coded actuator
- tamperproof screws
- Slot sealing plugs

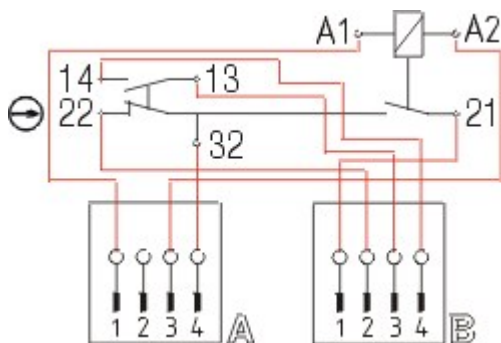

## Diagram



Note Diagram

⊖ positive break NC contact



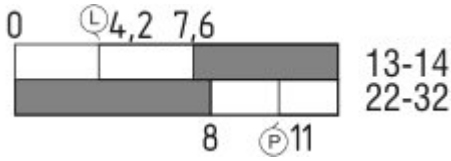

⊕ active

-  no active
-  Normally-open contact
-  Normally-closed contact

## Switch travel diagram



Notes Switch travel diagram

-  Contact closed
-  Contact open
-  Setting range
-  Break point
-  Positive opening sequence/- angle
- VS** adjustable range of NO contact
- VÖ** adjustable range of NC contact
- N** after travel

## Ordering suffix

The applicable ordering suffix is added at the end of the part number of the safety switch.

Order example: AZM 170-11ZRIA-ST-B6L 24 VAC/DC-**1637**

....-**1637**

0,3 µm gold-plated contacts

## Ordering code

AZM 170(1)-(2)Z(3)I(4)-(5)-(6)-(7) (8)

(1)		
without		IDC method of termination
<b>SK</b>		Screw connection
(2)		
<b>11</b>		1 Normally open contact (NO) / 1 Opener (NC)
<b>02</b>		2 Opener (NC)
(3)		
without		Latching force 5 N
<b>R</b>		Latching force 30 N
<b>I</b>		Individual coding
(4)		
without		Power to unlock
<b>A</b>		Power to lock
(5)		
without		cable gland
<b>ST</b>		Connector M12 x 1
(6)		
<b>B1</b>		with Actuator B1
<b>B5</b>		with Actuator B5
<b>B6L</b>		with Actuator B6L

<b>B6R</b>	with Actuator B6R
<b>(7)</b>	
<i>without</i>	Manual release
<b>2197</b>	Manual release from side (Power to unlock)
<b>1637</b>	gold-plated contacts
<b>(8)</b>	
<b>24VAC/DC</b>	U <sub>s</sub> 24 VAC/DC
<b>110VAC</b>	U <sub>s</sub> 110 VAC
<b>230VAC</b>	U <sub>s</sub> 230 VAC
	<b>AZM 170ST and AZM 170SK</b>
	<b>AZM 170ST-(1)Z(2)I(3)-(4)-(5)-(6) 24 VAC/DC</b>
	<b>AZM 170SK-(1)Z(2)I(3)-(4)-(5)-(6) 24 VAC/DC</b>
<b>(1)</b>	
<b>11/11</b>	1 Normally open contact (NO), 1 Opener (NC) / 1 Normally open contact (NO), 1 Opener (NC)
<b>11/02</b>	1 Normally open contact (NO), 1 Opener (NC) / 2 Opener (NC)
<b>12/00</b>	1 Normally open contact (NO), 2 Opener (NC) / -
<b>12/11</b>	1 Normally open contact (NO), 2 Opener (NC) / 1 Normally open contact (NO), 1 Opener (NC)
<b>12/02</b>	1 Normally open contact (NO), 2 Opener (NC) / 2 Opener (NC)
<b>02/01</b>	2 Opener (NC), - / 1 Opener (NC), -
<b>02/10</b>	2 Opener (NC), - / 1 Normally open contact (NO), -
<b>(2)</b>	
<i>without</i>	Latching force 5 N
<b>R</b>	Latching force 30 N
<b>(3)</b>	
<i>without</i>	Power to unlock
<b>A</b>	Power to lock
<b>(4)</b>	
<b>B1</b>	with Actuator B1
<b>B5</b>	with Actuator B5
<b>B6L</b>	with Actuator B6L
<b>B6R</b>	with Actuator B6R
<b>(5)</b>	
<b>1637</b>	gold-plated contacts
<b>(6)</b>	
<b>2197</b>	Manual release for Power to unlock

## Documents

---

**Operating instructions and Declaration of conformity** (fr) 886 kB, 18.11.2016

Code: mrl\_azm170i\_fr

**Operating instructions and Declaration of conformity** (it) 863 kB, 21.11.2016

Code: mrl\_azm170i\_it

**Operating instructions and Declaration of conformity** (es) 881 kB, 21.10.2016

Code: mrl\_azm170i\_es

**Operating instructions and Declaration of conformity** (nl) 865 kB, 18.11.2016

Code: mrl\_azm170i\_nl

**Operating instructions and Declaration of conformity** (da) 867 kB, 17.11.2016

Code: mrl\_azm170i\_da

**Operating instructions and Declaration of conformity** (de) 941 kB, 11.10.2016

Code: mrl\_azm170i\_de

**Operating instructions and Declaration of conformity** (pt) 870 kB, 21.11.2016

Code: mrl\_azm170i\_pt

**Operating instructions and Declaration of conformity** (pl) 906 kB, 21.11.2016

Code: mrl\_azm170i\_pl

**Operating instructions and Declaration of conformity** (jp) 1 MB, 20.04.2016

Code: mrl\_azm170i\_jp

**Operating instructions and Declaration of conformity** (en) 957 kB, 11.10.2016

Code: mrl\_azm170i\_en

**BG-test certificate** (en) 260 kB, 09.12.2015

Code: z\_m17p02

**BG-test certificate** (de) 257 kB, 09.12.2015

Code: z\_m17p01

**CCC certification** (en) 5 MB, 26.10.2018

Code: q\_371p02

**CCC certification** (cn) 5 MB, 26.10.2018

Code: q\_371p03

**EAC certification** (ru) 809 kB, 05.10.2015

Code: q\_6040p17\_ru

## Images

---

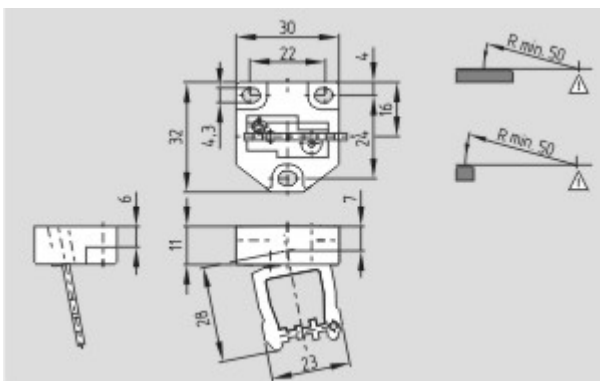

Dimensional drawing (miscellaneous)

---

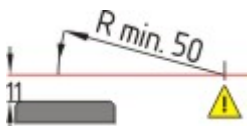

Actuating radius

---

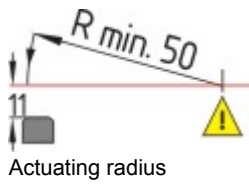

---

## System components

---

### Accessories



#### 101208493 - AZM 170-B CENTERING GUIDE

- for AZ 17 and AZM 170



#### 101100887 - TRIANGULAR KEY TK-M5

- For manual release using M5 triangular key, available as accessory
- For maintenance, installation, etc.

---

### Connector



#### A-K4M12

- Pre-wired cable
- 4-pole



#### S-K4M12

- Connector without cable
- 4-pole

---

K.A. Schmersal GmbH & Co. KG, Mödinghofe 30, D-42279 Wuppertal

The data and values have been checked thoroughly. Technical modifications and errors excepted.

Generiert am 13.02.2019 - 14:45:46h Kasbase 3.3.0.F.64I